



CATALOGUS

raam- en deurcomponenten

AXA HOME/SECURITY





AXA HOME SECURITY

UW **BETROUWBARE**
PARTNER

CATALOGUS

raam- en deurcomponenten

Inhoudsopgave	Pagina
Artikelnummer opbouw	6
Finish	6
Draairichting van deuren en ramen	7
Vorboren	7
Productposities	8
Keurmerken en markeringen	10
Inbraakmethodes en de AXA oplossingen	12
Scharnieren	15
Uitzetters	93
Raamsluitingen	137
Deurbeslag	183
Deursloten	273
Deurcilinders	299
Overige deurproducten	313
Overige raamproducten	331
ASSA Toegangsmanagement	337
Consumentenverpakkingen	341
Index	363



AXA HOME SECURITY

MET EEN HISTORIE DIE 114 JAAR TERUGGAAT, IS AXA EEN BEGRIP ALS HANG- & SLUITWERK LEVERANCIER EN HEEFT ZIJ EEN IJZERSTERKE NAAM OPGEBOUWD OP HET GEBIED VAN INBRAAKWERENDE BEVEILIGINGSPRODUCTEN.

Als professional bent u altijd op zoek naar goede, snelle en betrouwbare oplossingen. Als specialist met kennis van zaken op het gebied van hang- & sluitwerk biedt AXA u deze oplossingen. Een team van specialisten houdt zich dagelijks bezig met het ontwikkelen, produceren en vermarkten van AXA kwaliteitsproducten. **Kwaliteit** die zich openbaart in de gebruikte materialen, de maatvastheid, de afwerking en de levensduur van de producten. Maar ook kwaliteit die u terugziet in de leverbetrouwbaarheid, de uitgebreide documentatie en de expertise die u aantreft bij onze medewerkers.

Veiligheid is een belangrijk aspect binnen AXA. Niet alleen bestaat een belangrijk deel van het assortiment uit inbraakwerende producten die het gevoel van veiligheid in en om het huis moeten versterken, ook garanderen wij dat het bedienen van AXA producten altijd op een veilige manier mogelijk is. Een aantal van onze producten heeft zelfs een kinderveilige werking.

Een derde belangrijke pijler is **comfort**. Niet alleen in gebruik bij de eindconsument, maar ook in montage bij de professionele verwerker. Dit komt tot uiting door duidelijke montagehandleidingen en bijverpakt, gestandaardiseerd bevestigingsmateriaal, dat een snelle en accurate montage garandeert.

Uw veilige keuze

ALGEMENE INFORMATIE

ARTIKELNUMMER OPBOUW

Belangrijke posities van het artikelnummer:

De **1e** positie geeft aan tot welke specifieke productgroep het artikel behoort.

De **7e** en **8e** positie duiden op de artikel finish-uitvoering.

De toevoeging **(/6)** is een geseald, **(/7)** een losgestort, **(/G)** een gelijksluitend, **(/K)** een gekarteld, **(/V)** een veiligheidsuitvoering en **(/BL)** een in blister verpakt artikel.

1234-56-78 /X
 Productgroep Type Finish Toevoeging

FINISH

Om een lange levensduur van onze producten te garanderen voorzien we de metalen onderdelen van de producten van een corrosiewerende finish. Deze finish kan bestaan uit een galvanotechniek, een laklaag of een combinatie van beide.

Topcoat®

Een groot deel van de AXA scharnieren hebben een corrosiewerende Topcoat bescherming. Eerst wordt het staal verzinkt, daarna een hoogwaardige blauwpassivering toegepast en vervolgens wordt de speciale Topcoat toegepast. De zinkpassivering en Topcoat zijn met elkaar 'verweven', d.w.z. de lagen zijn niet scherp begrenst. Het resultaat is een oersterke corrosiewerende finish, waardoor een lange levensduur gewaarborgd is.

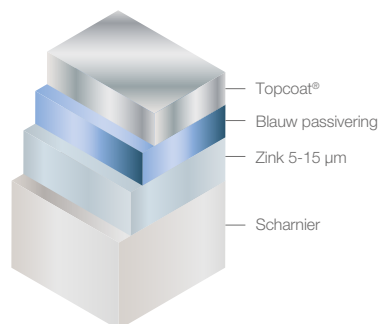

Xtremecoat®

Corrosie is bij extreme invloeden, zoals aan de kust of in zwembaden, vaak een groot probleem. De AXA Xtremecoat® finish beschermt het staal optimaal. Dankzij deze coating zijn extreme invloeden minder nadelig voor de levensduur van het scharnier. De Xtremecoat® is uitstekend toepasbaar op geschilderd Accoyahout en bestand tegen de hierin gebruikte zuren. Ook visueel is Xtremecoat® een fraaie oplossing en op een deur uitstekend te combineren met het AXA Veiligheidsbeslag.

Laklaag

In onze lakkerij maken we gebruik van poedercoaten. Dit is een elektrostatisch verfproces, waarbij het negatief geladen poeder op een positief geladen product verstoven wordt. Hierdoor blijft het poeder tijdelijk plakken, waarna het in een oven gesmolten of uitgemoffeld wordt.

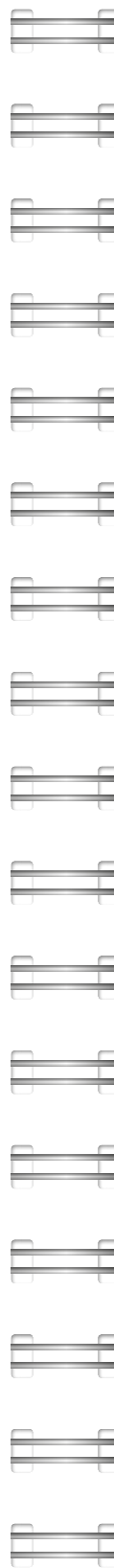

DRAAIRICHTING VAN DEUREN EN RAMEN

In verband met vaak voorkomende misverstanden over de draairichting van deuren en ramen, verzoeken wij u onderstaande aanduidingen volgens de ARGE (Union of the European Locksmithing and Ironworking Industries) aan te houden.

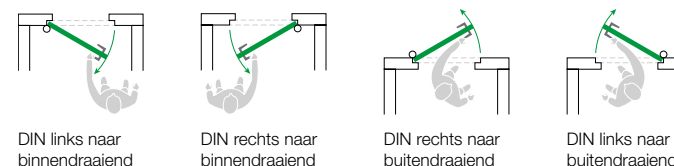

VOORBOREN

Bij het monteren is het belangrijk dat voor het schroeven de gaten worden voorgeboord. Bij niet voorgeboren gaat:

- het hout splijten,
- worden de houtvezels weggedrukt,
- raakt het totale schroefoppervlak de houtvezels maar beperkt en
- snijdt de spoed nauwelijks in het hout.

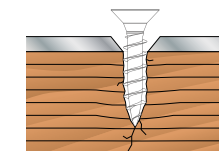

Niet voorgeboord

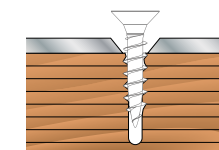

Voorgeboord

Hierdoor vindt slechts een beperkte hechting plaats en neemt de uittrekkraft sterk af (-/-50%) !

Schroefdikte	Voorboren naaldhout	Voorboren loofhout
3,5 mm	Ø 1,5 mm	Ø 2,5 mm
4,0 mm	Ø 2 mm	Ø 3 mm
4,5 mm	Ø 2,5 mm	Ø 3 mm
5,0 mm	Ø 3,0 mm	Ø 3,5 mm

BREDE RAMEN EN DEUREN

Bij een deurbreedte van meer dan 930 mm en een raambreedte van meer dan 800 mm, dient per 10 mm extra deur/raambreedte, het gewicht van de deur/raam met 1,5% extra gewicht ingeschaald te worden.

Voorbeeld: Deurbreedte 1030 mm en gewicht 80 kg > 100 mm breder dan 930 mm > 100 mm gedeeld door 10 mm = 10 x 1,5% = 15%, 80 kg x 1,15 = 92 kg.

ALGEMENE INFORMATIE

PRODUCTPOSITIES

Bij vrijwel alle producten geven wij een specifiek advies voor een optimale montagepositie op de productpagina. Op deze en volgende pagina's een globaal overzicht:

(VEILIGHEIDS)SCHARNIEREN

Scharnieren (uitgezonderd Heavy Duty)

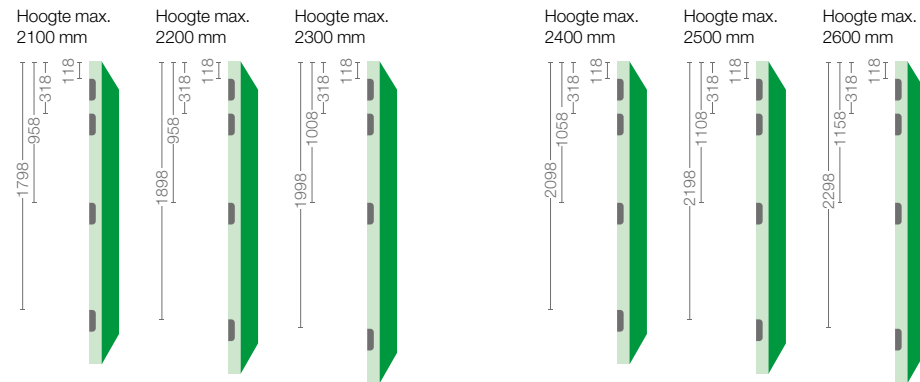

Heavy Duty scharnieren

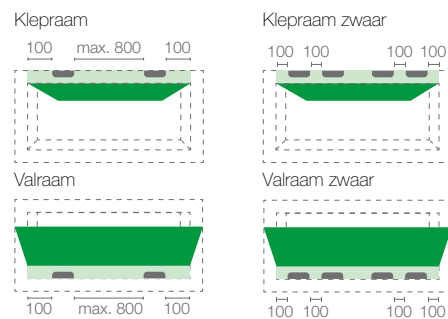
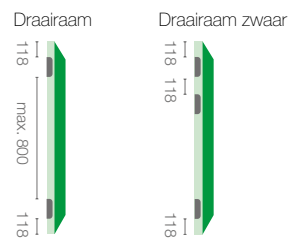
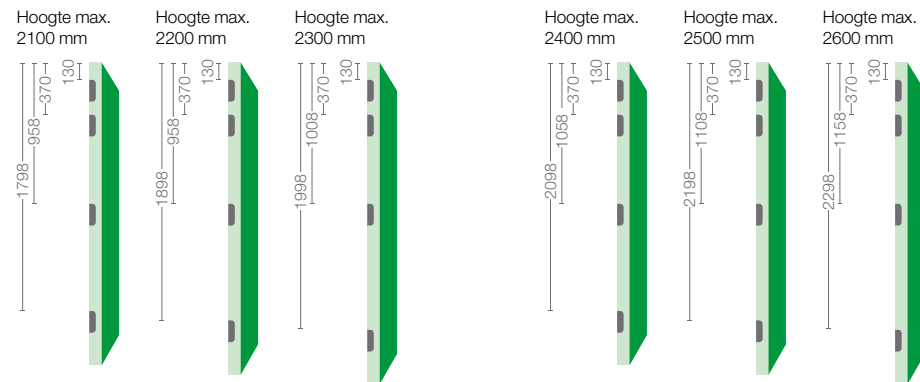

UITZETTERS

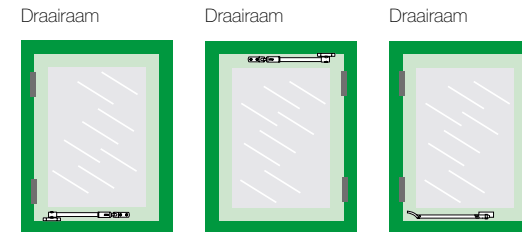
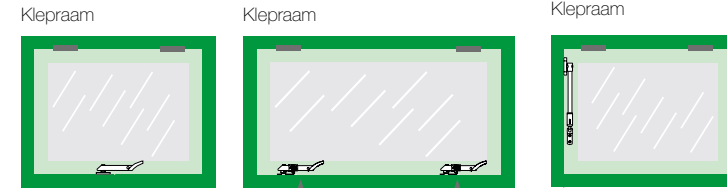

RAAMSLUITINGEN

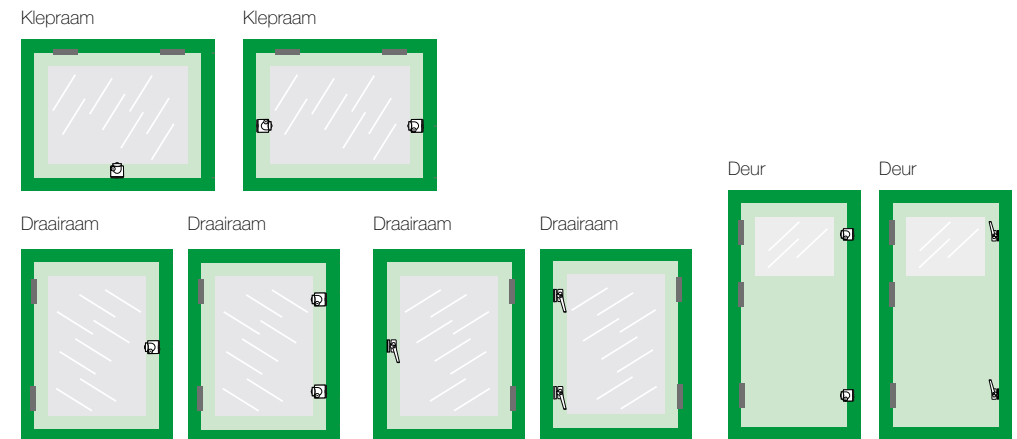

DEURBESLAG, DEURSLOTEN EN CILINDERS

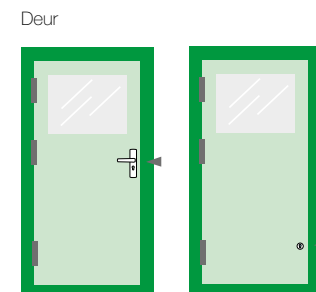

ALGEMENE INFORMATIE

KEURMERKEN EN MARKERINGEN

SKG-IKOB

De Stichting Kwaliteit Gevelbouw (SKG-IKOB), is een onafhankelijke instantie, die erop toeziet, dat veiligheidsproducten qua sterkte en duurzaamheid aan de eisen van de Nederlandse NEN-norm 5089 en de beoordelingsrichtlijn BRL 3104 voldoen. Het toegekende SKG-keur is, voorzover van toepassing, bij ieder afzonderlijk product vermeld.

Klasse aanduidingen certificaten



SKG één vinkje

Klasse "Aanvullend" aangegeven door een vinkje (✓), producten die een aanvullende bijdrage leveren aan de sociale veiligheid in situaties waarin niet volwaardig voldaan hoeft te worden aan eisen van inbraakwerendheid c.q. diefstalbeperking.



SKG 1 ster

Klasse "Standaard", aangegeven door middel van één ster (*), producten die, in combinatie met andere inbraakwerende voorzieningen, het binnendringen van inbrekers ten minste 3 minuten vertragen en voldoen aan eisen behorend bij de klasse "standaard" volgens Ontw. NEN 5089 (inclusief aanvullingen volgens bijlage IV van deze BRL).



SKG 2 sterren

Klasse "Zwaar", aangegeven door middel van twee sterren (**), producten die zelfstandig het binnendringen van inbrekers ten minste 3 minuten vertragen of producten die, in combinatie met andere inbraakwerende voorzieningen, het binnendringen van inbrekers ten minste 5 minuten vertragen en voldoen aan eisen behorend bij de klasse "zwaar" volgens Ontw. NEN 5089 (inclusief aanvullingen volgens bijlage IV van deze BRL).



SKG 3 sterren

Klasse "Extra zwaar", aangegeven door middel van drie sterren (***), producten die zelfstandig het binnendringen van inbrekers ten minste 5 minuten vertragen en voldoen aan eisen behorend bij de klasse "extra zwaar" volgens Ontw. NEN 5089 (inclusief aanvullingen volgens bijlage IV van deze BRL).

U vindt de **SKG certificaten** op onze site.

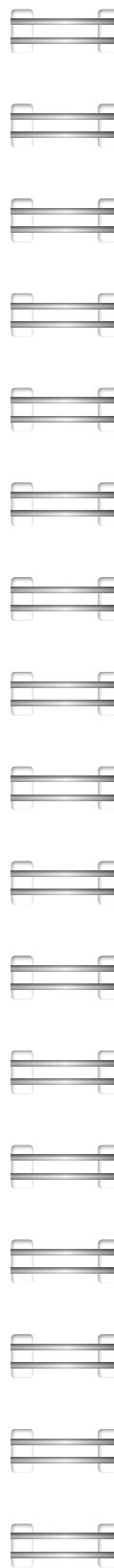

SKH Publicatie

Bijna al onze veiligheidsartikelen zijn ook getest op elementen voor de nieuwbouw. De goedgekeurde producten zijn opgenomen in de **SKH publicatie 98-08** en vindbaar op onze site.



CE Markering en Prestatieverklaringen

Iedereen die binnen de Europese Unie bouwproducten verhandelt heeft te maken met CE-markering. De producent geeft hiermee aan dat hij zijn product op de markt brengt overeenkomstig de voorschriften van in ons geval de Richtlijn bouwproducten (NEN-EN 1935). De CE-markering is geen keurmerk.

Het doel van de CE-markering is dus tweeledig van aard. Enerzijds is het doel de vrije handel binnen de lidstaten te bevorderen terwijl anderzijds de veiligheid in het gebruik van de producten wordt verhoogd.

Met ingang van 1 juli 2013 is op grond van de Europese Verordening bouwproducten (305/2011/EU) het voor fabrikanten verplicht de CE-markering toe te passen op alle bouwproducten die vallen onder een geharmoniseerde Europese norm.

Voor AXA betekent dit dat een groot deel van haar scharnier-assortiment (76 x76 mm en groter) onder de CE markering valt. Op onze site zijn de hiermee samenhangende **CE Prestatieverklaringen** (Declaration of Performance=DoP) te vinden.



Politie Keurmerk Veilig Wonen

Medio jaren negentig is op initiatief van de politie het Politie Keurmerk Veilig Wonen gestart. Met een aantal maatregelen en afspraken regelt het keurmerk veiligheid in en rond de woning. Een belangrijk aspect binnen het keurmerk is het treffen van maatregelen om de inbraakwerendheid van woningen te verhogen. Dit betekent veelal dat ramen en deuren voorzien moeten zijn van inbraakwerende producten.

Algemene verkoopvoorwaarden

Alle verkopen en/of leveringen geschieden uitsluitend onder de Algemene Leveringsvoorwaarden van de Verenigde Fabrieken van Hang- en Sluitwerk, zoals gedeponeerd ter Griffie van de Arrondissementsrechtbank te 's-Gravenhage, op 27 november 1997, onder nr. 129/1997. Een afschrift van deze voorwaarden treft u op de achterzijde van de orderbevestiging aan.

Handelsregister

Ingeschreven bij de Kamer van Koophandel te Utrecht – Handelsregister nr. 300 69 834

Aansprakelijkheid

Voor de in de catalogus opgenomen gegevens aanvaardt wij geen enkele aansprakelijkheid, evenmin als voor eventuele druk- en zetfouten. Wijzigingen in de constructie, uitvoering en verpakking van onze producten behouden wij ons voor. Alle auteursrechten worden nadrukkelijk voorbehouden. Gehele of gedeeltelijke overname uitsluitend na schriftelijke toestemming van AXA Stenman Nederland B.V.

ALGEMENE INFORMATIE

INBRAAKMETHODES EN DE AXA OPLOSSINGEN

	Inbraakmethode	Oplossing
Cilinder-trekken	Een cilinder wordt uit de deur getrokken door er een schroef in te draaien en mechanisch druk op te bouwen.	Plaatsen van AXA Veiligheidsbeslag (Premium of Curve met anti-kerntrek) met cilindertrekbeveiliging of een AXA Veiligheidscilinder met SKG® drie sterren.
Openbreken deur/raam	Bijvoorbeeld met een breekijzer of schroevendraaier.	Goed AXA hang- en sluitwerk in stevige kozijnen plaatsen.
Gaatjesboormethode	Onder het slot wordt een gat geboord. Vervolgens wordt met behulp van een geprepareerd voorwerp de sleutel, die de bewoners in het slot hebben laten zitten, omgedraaid.	AXA Veiligheids (combi)raamsluitingen (Oyster, 3329, 3320 of 3319) plaatsen die met een sleutel afsluitbaar zijn en deze ook consequent af te sluiten. Sleuteltjes uit de sloten verwijderen.
Flipperen	Met een bankpasje wordt aan de buitenkant de dagschoot van het slot terug gedrukt.	Deur altijd op slot te draaien of een AXA deurbeveiligingsstrip te plaatsen.
Hengelen	Met een stuk ijzer wordt door de brievenbus aan de deurklink gehengeld.	De deur altijd op slot te draaien, de sleutel verwijderen en eventueel een brievenzak of brievenbusafschermer plaatsen.
De Bulgaarse methode	Een cilinder die te ver uit het slot steekt, wordt met een tang afgebroken.	AXA Veiligheidsbeslag plaatsen, waardoor de cilinder maximaal 3 mm uitsteekt of beschermd wordt door anti-kerntrek.
Inbraak via bovenlichtjes	Bovenlichtjes zijn de kleine raampjes veelal boven een ander (draai)raam.	Hang- en sluitwerk volgens het Politiekeurmerk Veilig Wonen plaatsen. Een AXAflex Security of de AXA Remote volstaat. Een AXA Barrièrestang is vaak praktisch, omdat u dan het raam open kunt laten staan als u weggaat. Zorg er wel voor dat de maximale opening minder dan 15 cm is.
De babbeltruc	De inbrekers doen zich voor als iemand van de verzekering, bank, of als onderhoudsmonteur. Of ze hebben een meelijwekkend verhaal en komen zomaar binnen.	Laat niet zomaar iemand binnen, vraag om legitimatie en plaats eventueel een stevige AXA Kierstandhouder op de deur in combinatie met een AXA (digitale) deurspion.
Insluipen	Openstaande deur? Een inbreker is zo binnen.	Sluit altijd deuren en ramen, haal sleutels uit de sloten en houd ze uit het zicht of gebruik een kierstandhouder.



DEURBEVEILIGING



AXA Deurbeveiligingsstrip

Voorkomt dat de dagschoot kan worden teruggedrukt en er gemakkelijk een koevoet of schroevendraaier tussen gestoken kan worden.

pag. 314

AXA Veiligheidsbeslag

Veiligheidsbeslag is voorzien van anti-kerntrek die het onmogelijk maakt uw cilinder uit de deur te trekken en de deur te openen.

pag. 203

AXA Veiligheidscilinder

Betrouwbare veiligheidscilinders voor de gehele woning.

pag. 303

AXA Veiligheidsdeurslot

Inbraakwerend veiligheidsinsteekdeurslot voor een solide beveiliging.

pag. 281

AXA Veiligheidsscharnieren

Scharnieren met ingebouwde dievenklauw, waardoor het ook na het verwijderen van de scharnierpen, onmogelijk is de deur te openen.

pag. 24

AXA Barrièrestang

De doorkruip ruimte wordt verkleind tot maximaal 15 cm, waardoor naar binnen glippen niet meer mogelijk is.

pag. 332

AXA Oplegslot

Het is nauwelijks meer mogelijk om het raam snel open te wrikken met de veiligheids oplegsloten.

pag. 174

AXAflex Security combi-raamopener

Goed te ventileren en het uitzetraam is in gesloten toestand uitstekend beveiligd met de AXAflex Security.

pag. 102

AXA Veiligheidsraamsluiting

Door de extra versterkte sluitkom is de 3329 zeer veilig en weerstaat de meest actuele inbraakmethodes.

pag. 171

RAAMBEVEILIGING

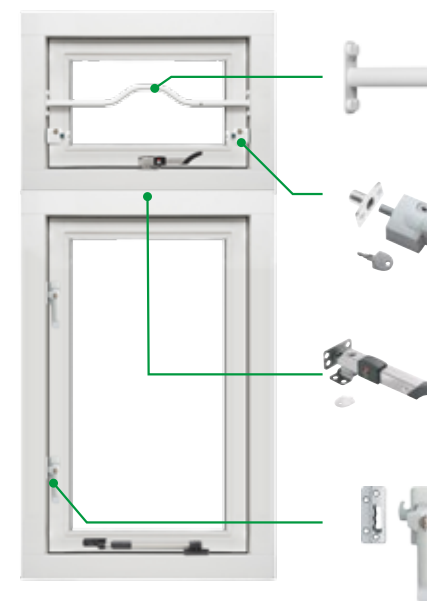

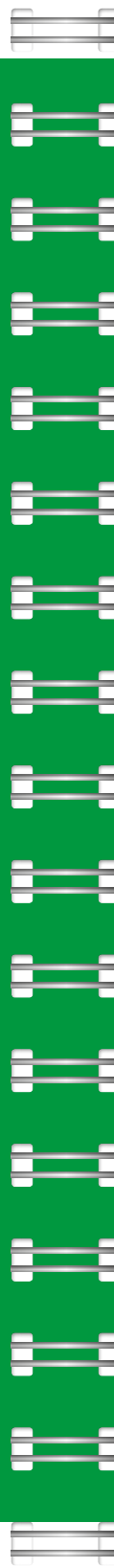

Scharnieren



Inhoudsopgave

Pagina

Smal scharnieren	16
Ongelagerde scharnieren	17
Ongelagerde klepscharnieren	23
Ongelagerde veiligheidsscharnieren	24
Nylonlager veiligheidsscharnieren	28
Venelite scharnieren	29
Inboor paumelles	37
Kogelstift paumelles	38
Kogellager scharnieren	56
Smart scharnieren	66
Heavy duty scharnieren	83
Dievenklauw	88
Onderdelen en accessoires scharnieren	89

1100 SMAL SCHARNIER

Toepassing

voor lichte constructie

TYPE 1100-00

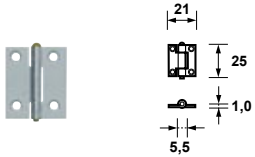

TYPE 1100-01

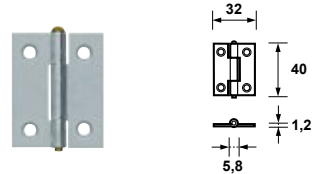

TYPE 1101-02

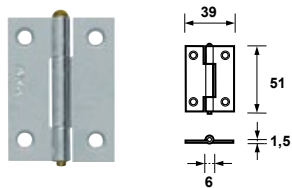

TYPE 1101-03

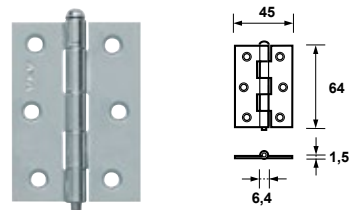

TYPE 1101-04

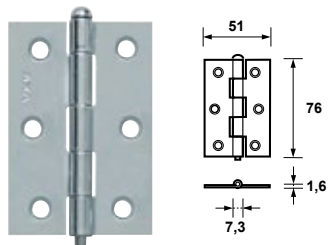

Artikelnummer	Materiaal/kleur/finish	Klein-verpakking	Groot-verpakking	Minimaal bestelaantal	Aanbevolen bevestiging
1100-00-52/0W	staal galvanisch verzinkt	100	600	100	2,5 x 20 mm
1100-01-52/0W	staal galvanisch verzinkt	100	600	100	3,0 x 20 mm
1101-02-52/E	staal galvanisch verzinkt	60	360	60	3,5 x 20 mm
1101-03-52/E	staal galvanisch verzinkt	40	240	40	3,5 x 20 mm
1101-04-52/E	staal galvanisch verzinkt	40	160	40	3,5 x 25 mm

Bijzonderheden:
/E = EAN sticker direct op product

Voorboren
ø 1,5 mm

ONGELAGERD SCHARNIER 1103

Toepassing

voor lichte constructie

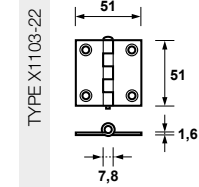

Belastingtabel

Staal

Type	Kg.	Aantal	Schroeflengte
1103-22	10	2	3,5 x 20 mm
	15	3	3,5 x 20 mm
	20	4	3,5 x 20 mm

Toepasbare draairichting

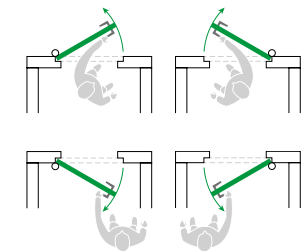

Artikelnummer	Materiaal/kleur/finish	Klein-verpakking	Groot-verpakking	Minimaal bestelaantal	Aanbevolen bevestiging
1103-22-23/E	staal Topcoat gegalvaniseerd	40	240	40	3,5 x 20 mm

Bijzonderheden:
/E = EAN sticker direct op product

Voorboren
ø 1,5 mm

1103 ONGELAGERD SCHARNIER



Toepassing
voor lichte constructie

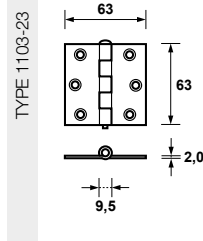

Belastingtabel

Staal

Type	Kg.	Aantal	Schroeflengte
1103-23	15	2	4,0 x 20 mm
	25	3	4,0 x 20 mm
	30	4	4,0 x 20 mm

RVS

Type	Kg.	Aantal	Schroeflengte
1103-23	15	2	4,0 x 20 mm
	25	3	4,0 x 20 mm
	30	4	4,0 x 20 mm

Toepasbare draairichting

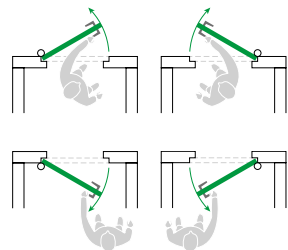

Artikelnummer	Materiaal/kleur/finish	Klein-verpakking	Groot-verpakking	Minimaal bestelaantal	Aanbevolen bevestiging
1103-23-23/E	staal Topcoat gegalvaniseerd	24	144	24	4,0 x 20 mm
1103-23-83/E	RVS gestraald	24	144	24	4,0 x 20 mm

Bijzonderheden:
/E = EAN sticker direct op product



ONGELAGERD SCHARNIER 1103



Toepassing
voor ramen

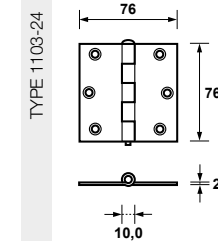

Productpositie

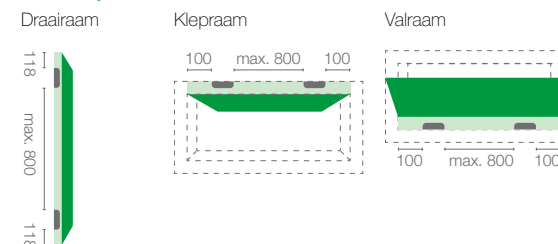

Belastingtabel

Staal

Type	Kg.	Aantal	Schroeflengte
1103-24	20	2	4,0 x 40 mm
	30	3	4,0 x 40 mm
	40	4	4,0 x 40 mm

RVS

Type	Kg.	Aantal	Schroeflengte
1103-24	10	2	4,0 x 40 mm
	15	3	4,0 x 40 mm
	20	4	4,0 x 40 mm

Toepasbare draairichting

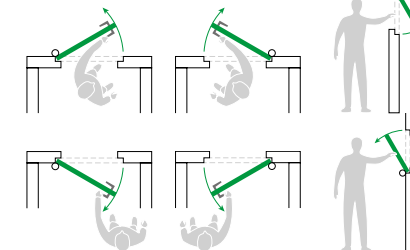

Artikelnummer	Materiaal/kleur/finish	Klein-verpakking	Groot-verpakking	Minimaal bestelaantal	Aanbevolen bevestiging
1103-24-23/E	staal Topcoat gegalvaniseerd	24	96	24	4,0 x 40 mm
1103-24-83/E	RVS gestraald	8	64	8	4,0 x 40 mm

Bijzonderheden:
/E = EAN sticker direct op product



1103 ONGELAGERD SCHARNIER



Toepassing
voor ramen en deuren

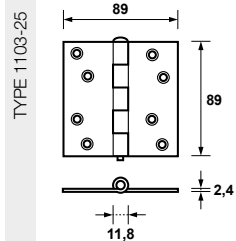

Productpositie

Deur

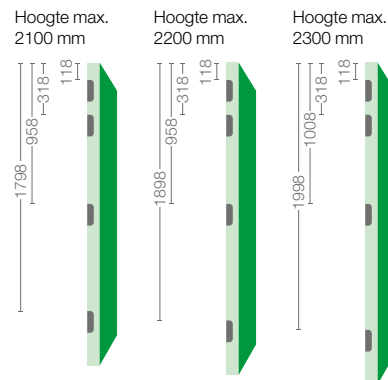

Belastingtabel

Staal

Type	Kg.	Aantal	Schroeflengte
1103-25	40	2	4,0 x 40 mm
	50	3	4,0 x 40 mm
	70	4	4,0 x 40 mm

Voor hogere deuren zie pag 8

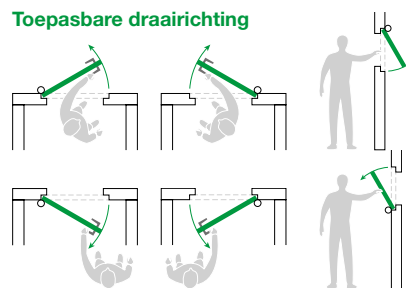
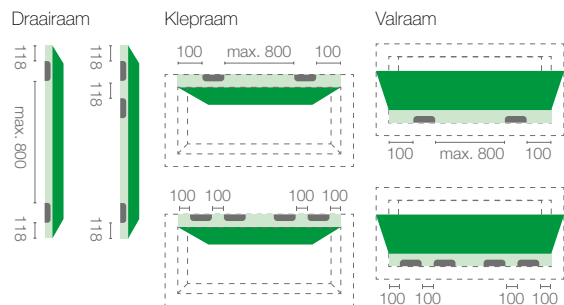

Artikelnummer	Materiaal/kleur/finish	Klein-verpakking	Groot-verpakking	Minimaal bestelaantal	Aanbevolen bevestiging
1103-25-23/E	staal Topcoat gegalvaniseerd	6	36	6	4,0 x 40 mm

Bijzonderheden:
/E = EAN sticker direct op product

Voorboren
ø 2,0 mm

ONGELAGERD SCHARNIER 1105



Toepassing
voor ramen

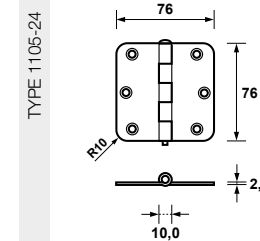

Productpositie

Draairaam

Klepraam

Valraam

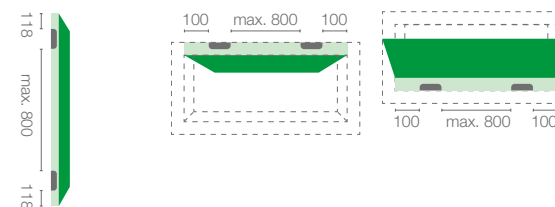

Belastingtabel

Staal

Type	Kg.	Aantal	Schroeflengte
1105-24	20	2	4,0 x 40 mm
	30	3	4,0 x 40 mm
	40	4	4,0 x 40 mm

RVS

Type	Kg.	Aantal	Schroeflengte
1105-24	10	2	4,0 x 40 mm
	15	3	4,0 x 40 mm
	20	4	4,0 x 40 mm

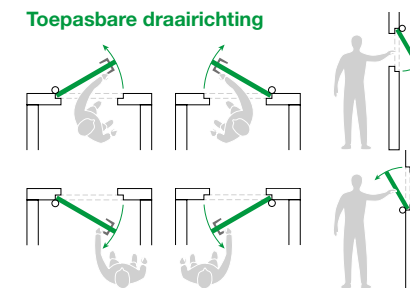

Artikelnummer	Materiaal/kleur/finish	Klein-verpakking	Groot-verpakking	Minimaal bestelaantal	Aanbevolen bevestiging
1105-24-23/E	staal Topcoat gegalvaniseerd	24	96	24	4,0 x 40 mm
1105-24-23/7K	staal Topcoat gegalvaniseerd	-	100	100	4,0 x 40 mm
1105-24-83/E	RVS gestraald	8	64	8	4,0 x 40 mm

Bijzonderheden:
/E = EAN sticker direct op product | /7K = los gestort en gekartelde pen

Voorboren
ø 2,0 mm

1105 ONGELAGERD SCHARNIER



Toepassing
voor ramen en deuren



TYPE 1105-25

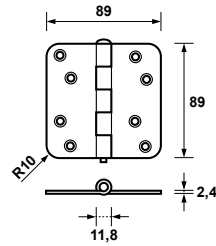

Productpositie

Deur

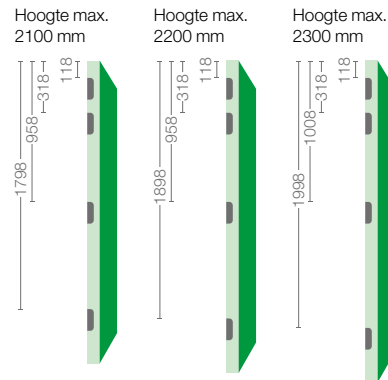

Belastingtabel

Staal

Type	Kg.	Aantal	Schroeflengte
1105-25	40	2	4,0 x 40 mm
	50	3	4,0 x 40 mm
	70	4	4,0 x 40 mm

RVS

Type	Kg.	Aantal	Schroeflengte
1105-25	30	2	4,0 x 40 mm
	40	3	4,0 x 40 mm
	60	4	4,0 x 40 mm

Voor hogere deuren zie pag 8

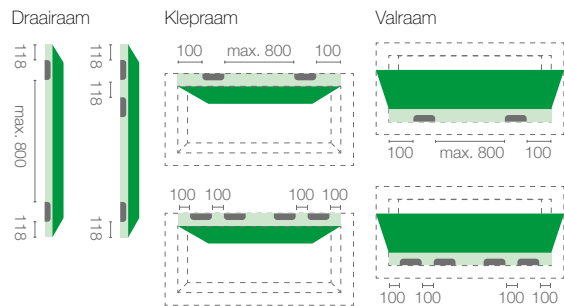

Toepasbare draairichting

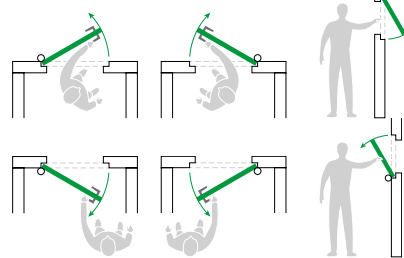

Artikelnummer	Materiaal/kleur/finish	Klein-verpakking	Groot-verpakking	Minimaal bestelaantal	Aanbevolen bevestiging
1105-25-23/E	staal Topcoat gegalvaniseerd	6	36	6	4,0 x 40 mm
1105-25-23/7	staal Topcoat gegalvaniseerd	-	50	50	4,0 x 40 mm
1105-25-83/7	RVS gestraald	-	50	50	4,0 x 40 mm

Bijzonderheden:
/E = EAN sticker direct op product | /7 = los gestort



ONGELAGERD KLEPSCHARNIER 1108

Toepassing
voor lichte constructies



TYPE 1108-20

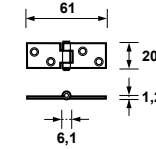

TYPE 1108-21

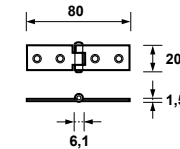

TYPE 1108-30

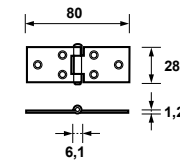

Artikelnummer	Materiaal/kleur/finish	Klein-verpakking	Groot-verpakking	Minimaal bestelaantal	Aanbevolen bevestiging
1108-20-22/OWE	staal galvanisch verzinkt	50	300	50	3,0 x 20 mm
1108-21-22/OWE	staal galvanisch verzinkt	30	180	30	3,0 x 20 mm
1108-30-22/OWE	staal galvanisch verzinkt	30	180	30	3,0 x 20 mm

Bijzonderheden:
/OWE = EAN sticker direct op product



1113 ONGELAGERD VEILIGHEIDSSCHARNIER

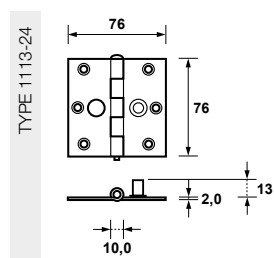

Productpositie

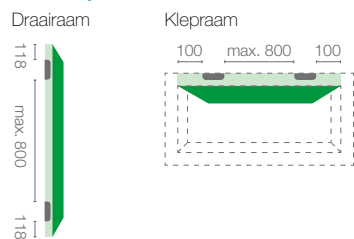

Belastingtabel

Staal

Type	Kg.	Aantal	Schroeflengte
1113-24	20	2	4,0 x 40 mm
	30	3	4,0 x 40 mm
	40	4	4,0 x 40 mm

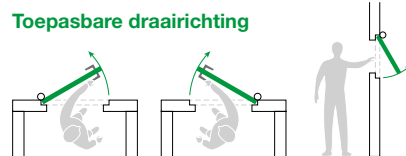

Artikelnummer	Materiaal/kleur/finish	Klein-verpakking	Groot-verpakking	Minimaal bestelaantal	Aanbevolen bevestiging
1113-24-23/VE	staal Topcoat gegalvaniseerd	15	60	15	4,0 x 40 mm

Bijzonderheden:
/VE = EAN sticker direct op product



ONGELAGERD VEILIGHEIDSSCHARNIER 1113

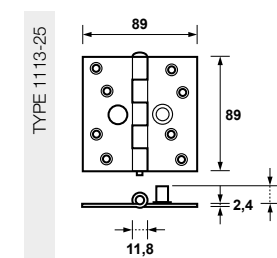

Productpositie

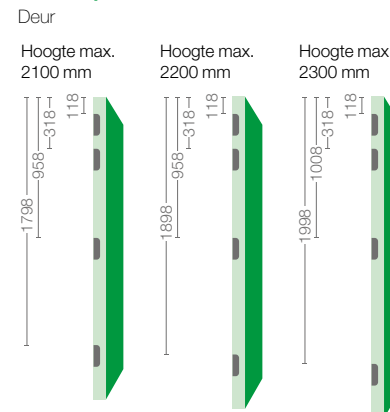

Belastingtabel

Staal

Type	Kg.	Aantal	Schroeflengte
1113-25	40	2	4,0 x 40 mm
	50	3	4,0 x 40 mm
	70	4	4,0 x 40 mm

Voor hogere deuren zie pag 8

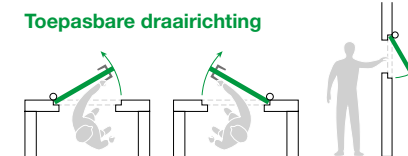
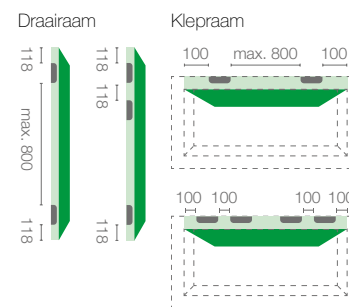

Artikelnummer	Materiaal/kleur/finish	Klein-verpakking	Groot-verpakking	Minimaal bestelaantal	Aanbevolen bevestiging
1113-25-23/4VE	staal Topcoat gegalvaniseerd	6	24	6	4,0 x 40 mm

Bijzonderheden:
/VE = EAN sticker direct op product



1114 ONGELAGERD VEILIGHEIDSSCHARNIER



Toepassing
voor ramen

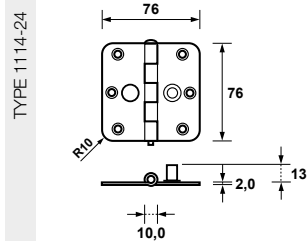

Productpositie

Draairaam Klepraam

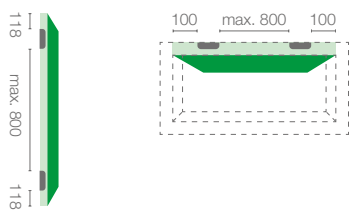

Belastingtabel

Staal

Type	Kg.	Aantal	Schroeflengte
1114-24	20	2	4,0 x 40 mm
	30	3	4,0 x 40 mm
	40	4	4,0 x 40 mm

RVS

Type	Kg.	Aantal	Schroeflengte
1114-24	10	2	4,0 x 40 mm
	15	3	4,0 x 40 mm
	20	4	4,0 x 40 mm

Toepasbare draairichting

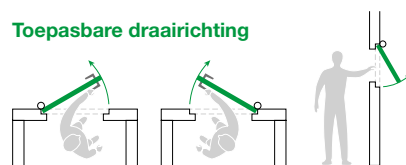

Artikelnummer	Materiaal/kleur/finish	Klein-verpakking	Groot-verpakking	Minimaal bestelaantal	Aanbevolen bevestiging
1114-24-23/VE	staal Topcoat gegalvaniseerd	15	60	15	4,0 x 40 mm
1114-24-23/7V	staal Topcoat gegalvaniseerd	-	100	100	4,0 x 40 mm
1114-24-83/7V	RVS gestraald	-	100	100	4,0 x 40 mm

Bijzonderheden:
/VE = EAN sticker direct op product | /7V = los gestort

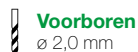

ONGELAGERD VEILIGHEIDSSCHARNIER 1114



Toepassing
ramen en buitendeuren

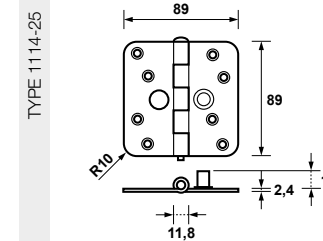

Productpositie

Deur

Hoogte max. 2100 mm Hoogte max. 2200 mm Hoogte max. 2300 mm

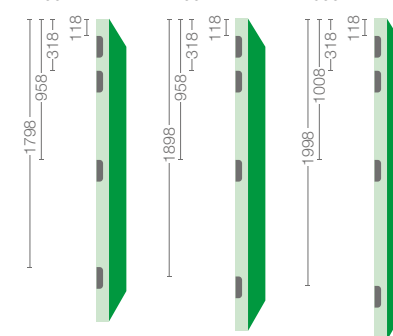

Voor hogere deuren zie pag 8

Belastingtabel

Staal

Type	Kg.	Aantal	Schroeflengte
1114-25	40	2	4,0 x 40 mm
	50	3	4,0 x 40 mm
	70	4	4,0 x 40 mm

RVS

Type	Kg.	Aantal	Schroeflengte
1114-25	30	2	4,0 x 40 mm
	40	3	4,0 x 40 mm
	60	4	4,0 x 40 mm

Toepasbare draairichting

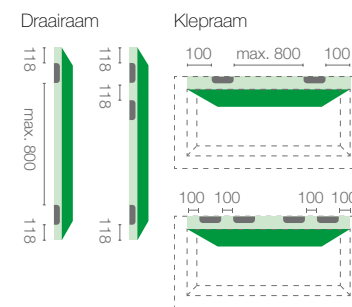
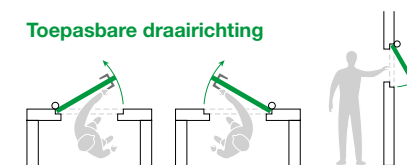

Artikelnummer	Materiaal/kleur/finish	Klein-verpakking	Groot-verpakking	Minimaal bestelaantal	Aanbevolen bevestiging
1114-25-23/4VE	staal Topcoat gegalvaniseerd	6	24	6	4,0 x 40 mm
1114-25-23/7KV4	staal Topcoat gegalvaniseerd	-	50	50	4,0 x 40 mm
1114-25-83/7KV4	RVS gestraald	-	50	50	4,0 x 40 mm

Bijzonderheden:
/VE = EAN sticker direct op product | /7KV = los gestort en gekartelde pen



1132 NYLONLAGER VEILIGHEIDSSCHARNIER



Toepassing
voor ramen en buitendeuren



TYPE 1132-25

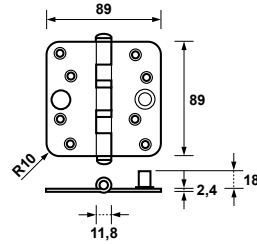

Productpositie

Deur

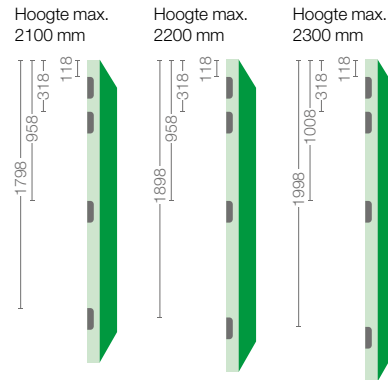

Belastingtabel

Staal

Type	Kg.	Aantal	Schroeflengte
1132-25	50	2	4,0 x 40 mm
	65	3	4,0 x 40 mm
	80	4	4,0 x 40 mm

Voor hogere deuren zie pag 8

Draairaam Klepraam

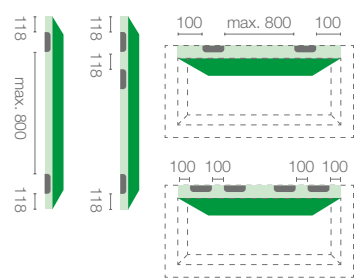

Toepasbare draairichting

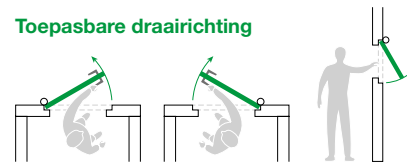

Artikelnummer	Materiaal/kleur/finish	Klein-verpakking	Groot-verpakking	Minimaal bestelaantal	Aanbevolen bevestiging
1132-25-23/7V4	staal Topcoat gegalvaniseerd	-	50	50	4,0 x 40 mm

Bijzonderheden:
/7V4 = los gestort



VENELITE SCHARNIER 1134



Toepassing
voor ramen



TYPE 1134-55

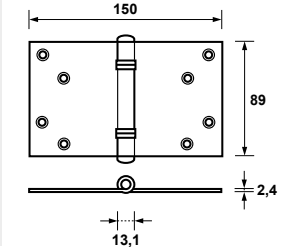

Productpositie

Draairaam



Belastingtabel

Staal

Type	Kg.	Aantal	Schroeflengte
1134-55	20	2	4,0 x 40 mm
	30	3	4,0 x 40 mm
	40	4	4,0 x 40 mm

Toepasbare draairichting

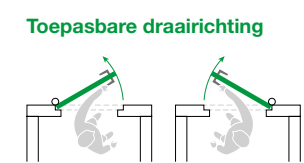

Artikelnummer	Materiaal/kleur/finish	Klein-verpakking	Groot-verpakking	Minimaal bestelaantal	Aanbevolen bevestiging
1134-55-23/E	staal Topcoat gegalvaniseerd	6	24	6	4,0 x 40 mm

Bijzonderheden:
/E = EAN sticker direct op product



1135 VENELITE VEILIGHEIDSSCHARNIER

Toepassing
voor ramen



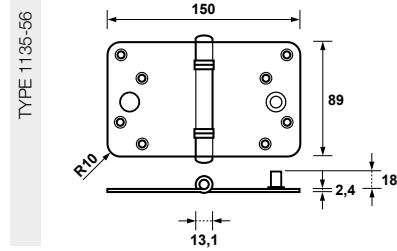

Productpositie

Draairaam



Belastingtabel

Staal

Type	Kg.	Aantal	Schroeflengte
1135-56	20	2	4,0 x 40 mm
	30	3	4,0 x 40 mm
	40	4	4,0 x 40 mm

Toepasbare draairichting

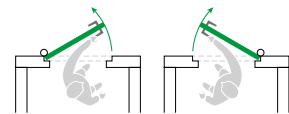

Artikelnummer	Materiaal/kleur/finish	Klein-verpakking	Groot-verpakking	Minimaal bestelaantal	Aanbevolen bevestiging
1135-56-23/7V	staal Topcoat gegalvaniseerd	-	25	25	4,0 x 40 mm

Bijzonderheden:
/7V = los gestort

Voorboren
ø 2,0 mm

VENELITE VEILIGHEIDSSCHARNIER 1136

Toepassing
voor ramen



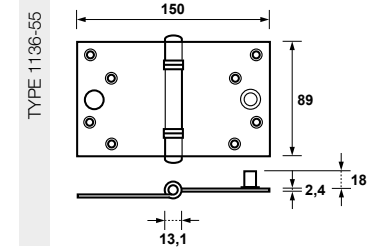

Productpositie

Draairaam



Belastingtabel

Staal

Type	Kg.	Aantal	Schroeflengte
1136-55	20	2	4,0 x 40 mm
	30	3	4,0 x 40 mm
	40	4	4,0 x 40 mm

Toepasbare draairichting

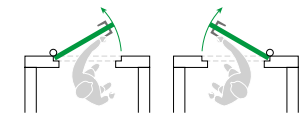

Artikelnummer	Materiaal/kleur/finish	Klein-verpakking	Groot-verpakking	Minimaal bestelaantal	Aanbevolen bevestiging
1136-55-23/VE	staal Topcoat gegalvaniseerd	-	16	4	4,0 x 40 mm

Bijzonderheden:
/VE = EAN sticker direct op product

Voorboren
ø 2,0 mm

1137 VENELITE SCHARNIER



Toepassing
voor ramen

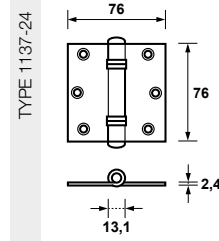

Productpositie

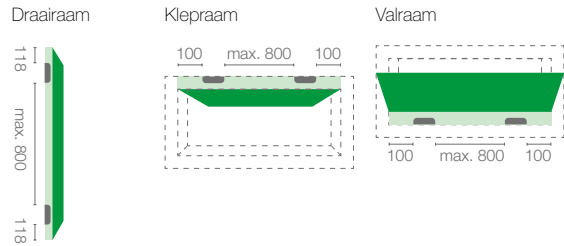

Belastingtabel

Staal				
Type	Kg.	Aantal	Schroeflengte	
1137-24	15	2	4,0 x 40 mm	
	25	3	4,0 x 40 mm	
	30	4	4,0 x 40 mm	

Toepasbare draairichting

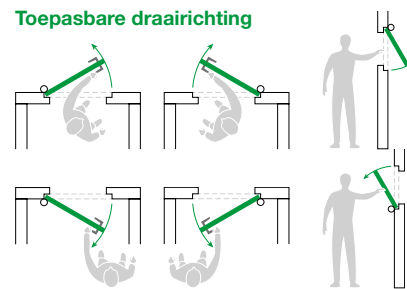

Artikelnummer	Materiaal/kleur/finish	Klein-verpakking	Groot-verpakking	Minimaal bestelaantal	Aanbevolen bevestiging
1137-24-23/E	staal Topcoat gegalvaniseerd	6	48	6	4,0 x 40 mm

Bijzonderheden:
/E = EAN sticker direct op product



VENELITE SCHARNIER 1137



Toepassing
voor ramen

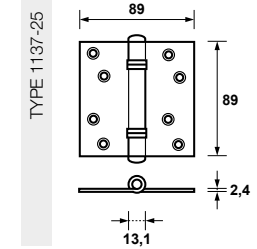

Productpositie

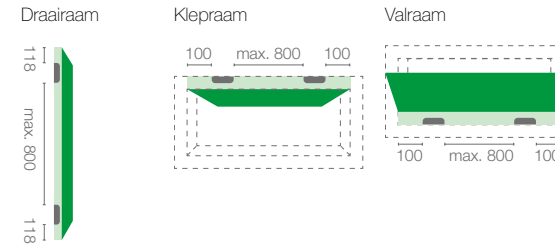

Belastingtabel

Staal				
Type	Kg.	Aantal	Schroeflengte	
1137-25	25	2	4,0 x 40 mm	
	35	3	4,0 x 40 mm	
	45	4	4,0 x 40 mm	

Toepasbare draairichting

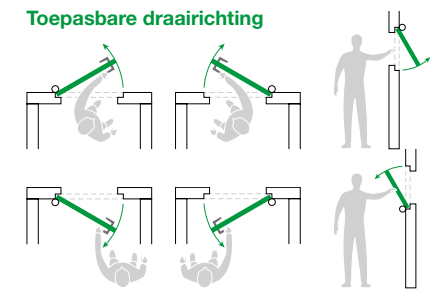

Artikelnummer	Materiaal/kleur/finish	Klein-verpakking	Groot-verpakking	Minimaal bestelaantal	Aanbevolen bevestiging
1137-25-23/E	staal Topcoat gegalvaniseerd	6	36	6	4,0 x 40 mm

Bijzonderheden:
/E = EAN sticker direct op product



1138 VENELITE SCHARNIER



Toepassing
voor ramen



TYPE 1138-25

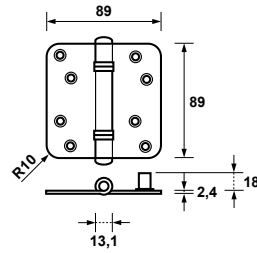

Productpositie

Draairaam Klepraam

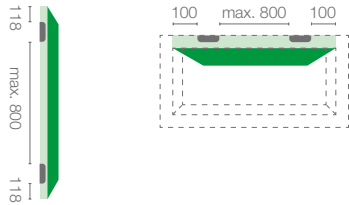

Belastingtabel

Staal

Type	Kg.	Aantal	Schroeflengte
1138-25	25	2	4,0 x 40 mm
	35	3	4,0 x 40 mm
	45	4	4,0 x 40 mm

Toepasbare draairichting

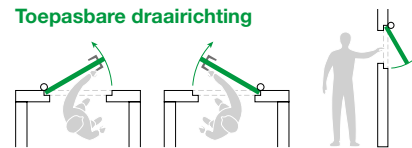

Artikelnummer	Materiaal/kleur/finish	Klein-verpakking	Groot-verpakking	Minimaal bestelaantal	Aanbevolen bevestiging
1138-25-23/7	staal Topcoat gegalvaniseerd	-	50	50	4,0 x 40 mm

Bijzonderheden:
/7 = los gestort



VENELITE VEILIGHEIDS SCHARNIER 1138



Toepassing
voor ramen



TYPE 1138-35

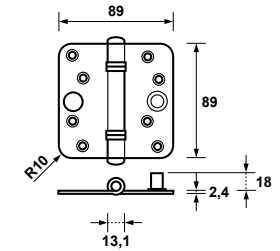

Productpositie

Draairaam Klepraam

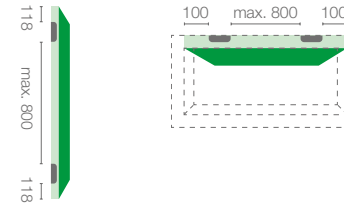

Belastingtabel

Staal

Type	Kg.	Aantal	Schroeflengte
1138-35	25	2	4,0 x 40 mm
	35	3	4,0 x 40 mm
	45	4	4,0 x 40 mm

Toepasbare draairichting

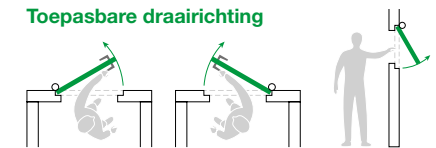

Artikelnummer	Materiaal/kleur/finish	Klein-verpakking	Groot-verpakking	Minimaal bestelaantal	Aanbevolen bevestiging
1138-35-23/7V4	staal Topcoat gegalvaniseerd	-	50	50	4,0 x 40 mm

Bijzonderheden:
/7V4 = los gestort



1139 VENELITE VEILIGHEIDS SCHARNIER



Toepassing
voor ramen



TYPE 1139-25

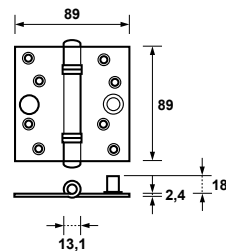

Productpositie

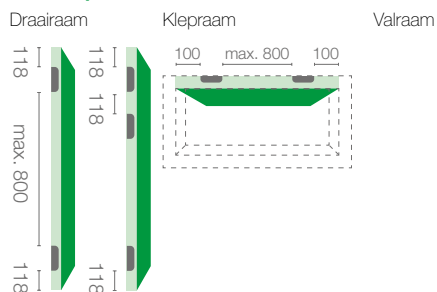

Belastingtabel

Staal

Type	Kg.	Aantal	Schroeflengte
1139-25	25	2	4,0 x 40 mm
	35	3	4,0 x 40 mm
	45	4	4,0 x 40 mm

Toepasbare draairichting

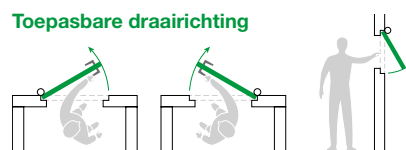

Artikelnummer	Materiaal/kleur/finish	Klein-verpakking	Groot-verpakking	Minimaal bestelaantal	Aanbevolen bevestiging
1139-25-23/V4E	staal Topcoat gegalvaniseerd	-	50	50	4,0 x 40 mm

Bijzonderheden:
V4E = EAN sticker direct op product

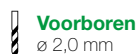

INBOORPAUMELLE 1177



Toepassing
voor opdekdeuren in houten kozijnen

TYPE 1177-10

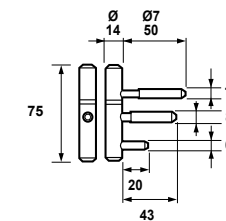

Toepasbare draairichting

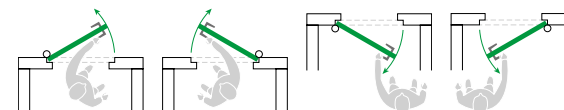

Belastingtabel

Staal

Type	Kg.	Aantal
1177-10	20	2
	30	3

Artikelnummer	Materiaal/kleur/finish	Klein-verpakking	Groot-verpakking	Minimaal bestelaantal	Aanbevolen bevestiging
1177-10-37/OT	staal vernikkeld	10	180	10	-
1177-10-37/OTE	staal vernikkeld	5 (2 st.)	20 (2 st.)	5 (2 st.)	-

Bijzonderheden:
2 st. = 2 producten per kleinverpakking

Toepassing

voor opdekdeuren in metalen kozijnen



TYPE 1177-23

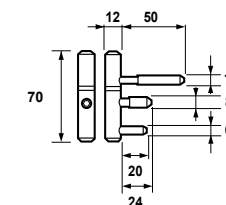

Toepasbare draairichting

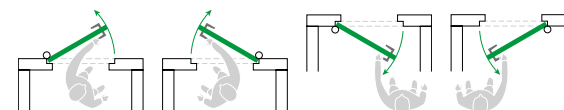

Belastingtabel

Staal

Type	Kg.	Aantal
1177-23	20	2
	30	3

Artikelnummer	Materiaal/kleur/finish	Klein-verpakking	Groot-verpakking	Minimaal bestelaantal	Aanbevolen bevestiging
1177-23-37/OTE	staal vernikkeld	5 (2 st.)	20 (2 st.)	5 (2 st.)	-

Bijzonderheden:
2 st. = 2 producten per kleinverpakking

1200 VEILIGHEIDS KOGELSTIFTPAUMELLE

Toepassing

voor ver openslaande buitendeuren

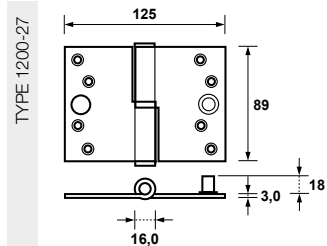

Productpositie

Deur

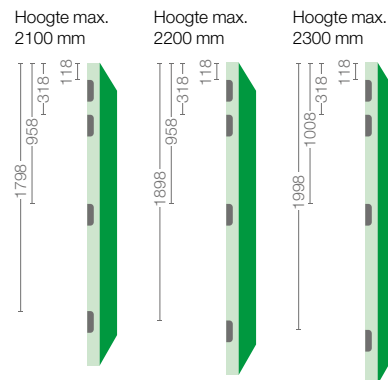

Voor hogere deuren zie pag 8

Belastingtabel

Staal

Type	Kg.	Aantal	Schroeflengte
1200-27	50	2	4,0 x 45 mm
	70	3	4,0 x 45 mm
	90	4	4,0 x 45 mm

Toepasbare draairichting

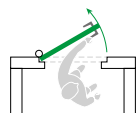

Artikelnummer	Materiaal/kleur/finish	Klein-verpakking	Groot-verpakking	Minimaal bestelaantal	Aanbevolen bevestiging
1200-27-23/V4E	staal Topcoat gegalvaniseerd	4	16	4	4,0 x 45 mm

Bijzonderheden:
/V4E = EAN sticker direct op product



VEILIGHEIDS KOGELSTIFTPAUMELLE 1200

Toepassing

voor ver openslaande buitendeuren

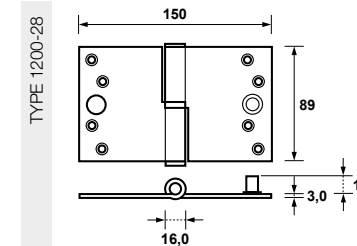

Productpositie

Deur



Voor hogere deuren zie pag 8

Belastingtabel

Staal

Type	Kg.	Aantal	Schroeflengte
1200-28	40	2	4,0 x 45 mm
	50	3	4,0 x 45 mm
	65	4	4,0 x 45 mm

Toepasbare draairichting

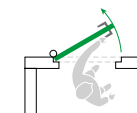

Artikelnummer	Materiaal/kleur/finish	Klein-verpakking	Groot-verpakking	Minimaal bestelaantal	Aanbevolen bevestiging
1200-28-23/V4E	staal Topcoat gegalvaniseerd	4	16	4	4,0 x 45 mm

Bijzonderheden:
/V4E = EAN sticker direct op product



1200 VEILIGHEIDS KOGELSTIFTPAUMELLE

Toepassing

voor ver openslaande buitendeuren



TYPE 1200-29

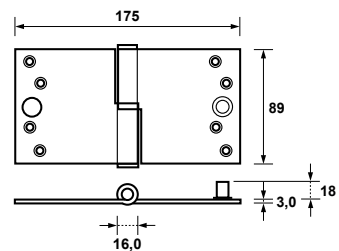

Productpositie

Deur

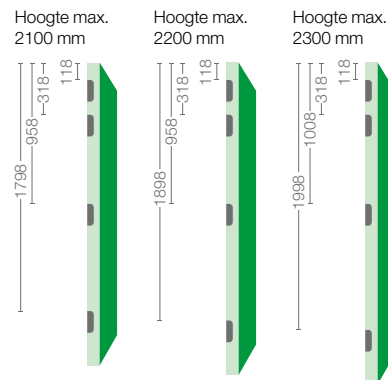

Voor hogere deuren zie pag 8

Belastingtabel

Staal

Type	Kg.	Aantal	Schroeflengte
1200-29	30	2	4,0 x 45 mm
	40	3	4,0 x 45 mm
	55	4	4,0 x 45 mm

Toepasbare draairichting

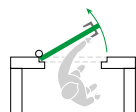

Artikelnummer	Materiaal/kleur/finish	Klein-verpakking	Groot-verpakking	Minimaal bestelaantal	Aanbevolen bevestiging
1200-29-23/V4E	staal Topcoat gegalvaniseerd	4	16	4	4,0 x 45 mm

Bijzonderheden:
/V4E = EAN sticker direct op product



VEILIGHEIDS KOGELSTIFTPAUMELLE 1200

Toepassing

voor ver openslaande buitendeuren



TYPE 1200-37

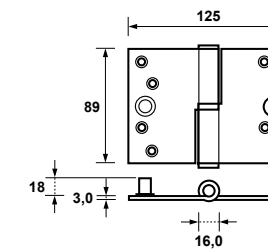

Productpositie

Deur

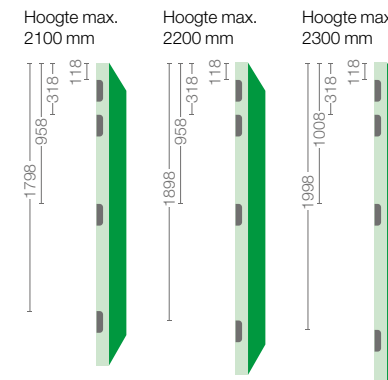

Voor hogere deuren zie pag 8

Belastingtabel

Staal

Type	Kg.	Aantal	Schroeflengte
1200-37	50	2	4,0 x 45 mm
	70	3	4,0 x 45 mm
	90	4	4,0 x 45 mm

Toepasbare draairichting

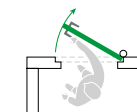

Artikelnummer	Materiaal/kleur/finish	Klein-verpakking	Groot-verpakking	Minimaal bestelaantal	Aanbevolen bevestiging
1200-37-23/V4E	staal Topcoat gegalvaniseerd	4	16	4	4,0 x 45 mm

Bijzonderheden:
/V4E = EAN sticker direct op product



1200 VEILIGHEIDS KOGELSTIFTPAUMELLE

Toepassing

voor ver openslaande buitendeuren



TYPE 1200-38

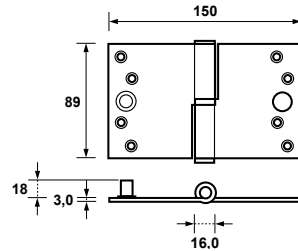

Productpositie

Deur

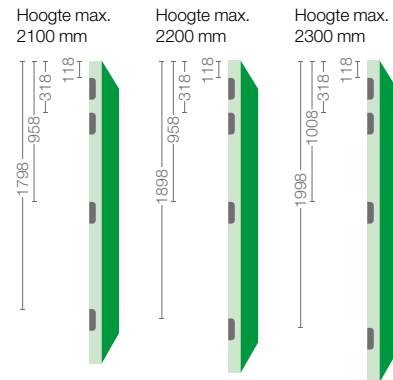

Voor hogere deuren zie pag 8

Belastingtabel

Staal

Type	Kg.	Aantal	Schroeflengte
1200-38	40	2	4,0 x 45 mm
	50	3	4,0 x 45 mm
	65	4	4,0 x 45 mm

Toepasbare draairichting



Artikelnummer	Materiaal/kleur/finish	Klein-verpakking	Groot-verpakking	Minimaal bestelaantal	Aanbevolen bevestiging
1200-38-23/V4E	staal Topcoat gegalvaniseerd	4	16	4	4,0 x 45 mm

Bijzonderheden:
/V4E = EAN sticker direct op product



VEILIGHEIDS KOGELSTIFTPAUMELLE 1200

Toepassing

voor ver openslaande buitendeuren



TYPE 1200-39

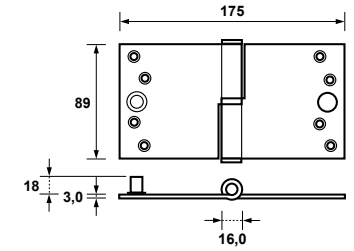

Productpositie

Deur

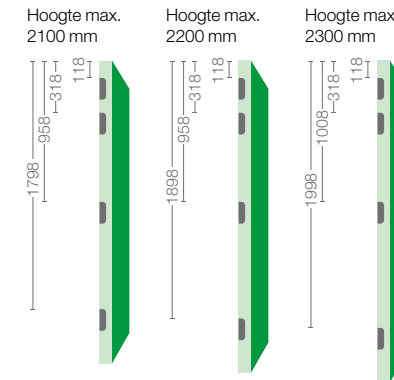

Voor hogere deuren zie pag 8

Belastingtabel

Staal

Type	Kg.	Aantal	Schroeflengte
1200-39	30	2	4,0 x 45 mm
	40	3	4,0 x 45 mm
	55	4	4,0 x 45 mm

Toepasbare draairichting

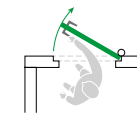

Artikelnummer	Materiaal/kleur/finish	Klein-verpakking	Groot-verpakking	Minimaal bestelaantal	Aanbevolen bevestiging
1200-39-23/V4E	staal Topcoat gegalvaniseerd	4	16	4	4,0 x 45 mm

Bijzonderheden:
/V4E = EAN sticker direct op product



1201 KOGELSTIFTPAUMELLE



Toepassing
voor deuren

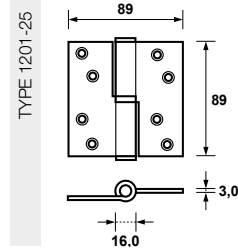

Productpositie

Deur

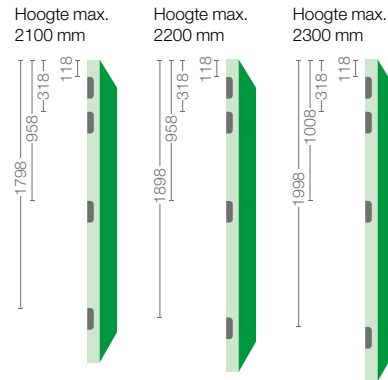

Voor hogere deuren zie pag 8

Belastingtabel

Staal

Type	Kg.	Aantal	Schroeflengte
1201-25	65	2	4,0 x 45 mm
	90	3	4,0 x 45 mm
	105	4	4,0 x 45 mm

RVS

Type	Kg.	Aantal	Schroeflengte
1201-25	65	2	4,0 x 45 mm
	90	3	4,0 x 45 mm
	105	4	4,0 x 45 mm

Toepasbare draairichting

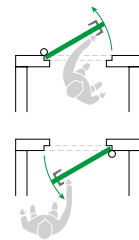

Artikelnummer	Materiaal/kleur/finish	Klein-verpakking	Groot-verpakking	Minimaal bestelaantal	Aanbevolen bevestiging
1201-25-23/E	staal Topcoat gegalvaniseerd	6	36	6	4,0 x 45 mm
1201-25-81/E	RVS geborsteld	6	36	6	4,0 x 45 mm

Bijzonderheden:
/E = EAN sticker direct op product



VEILIGHEIDS KOGELSTIFTPAUMELLE 1201



Toepassing
voor buitendeuren

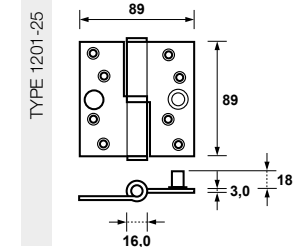

Productpositie

Deur

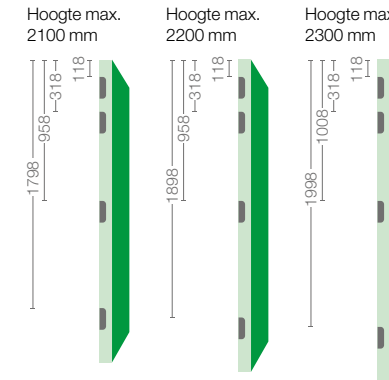

Voor hogere deuren zie pag 8

Belastingtabel

Staal

Type	Kg.	Aantal	Schroeflengte
1201-25	65	2	4,0 x 45 mm
	90	3	4,0 x 45 mm
	105	4	4,0 x 45 mm

Toepasbare draairichting

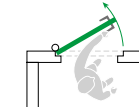

Artikelnummer	Materiaal/kleur/finish	Klein-verpakking	Groot-verpakking	Minimaal bestelaantal	Aanbevolen bevestiging
1201-25-23/V4E	staal Topcoat gegalvaniseerd	4	48	4	4,0 x 45 mm

Bijzonderheden:
/V4E = EAN sticker direct op product



1201 KOGELSTIFTPAUMELLE



Toepassing
voor deuren

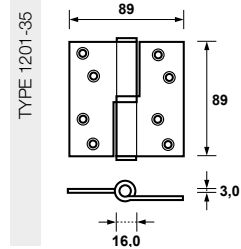

Productpositie

Deur

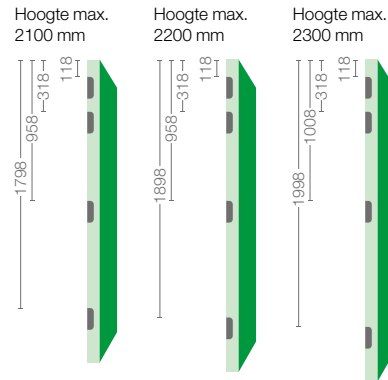

Voor hogere deuren zie pag 8

Belastingtabel

Staal

Type	Kg.	Aantal	Schroeflengte
1201-35	65	2	4,0 x 45 mm
	90	3	4,0 x 45 mm
	105	4	4,0 x 45 mm

RVS

Type	Kg.	Aantal	Schroeflengte
1201-35	65	2	4,0 x 45 mm
	90	3	4,0 x 45 mm
	105	4	4,0 x 45 mm

Toepasbare draairichting

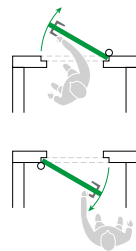

Artikelnummer	Materiaal/kleur/finish	Klein-verpakking	Groot-verpakking	Minimaal bestelaantal	Aanbevolen bevestiging
1201-35-23/E	staal Topcoat gegalvaniseerd	4	48	4	4,0 x 45 mm
1201-35-81/E	RVS geborsteld	4	48	4	4,0 x 45 mm

Bijzonderheden:
/E = EAN sticker direct op product

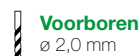

VEILIGHEIDS KOGELSTIFTPAUMELLE 1201



Toepassing
voor buitendeuren

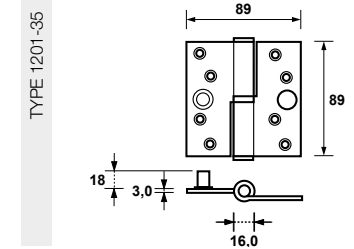

Productpositie

Deur

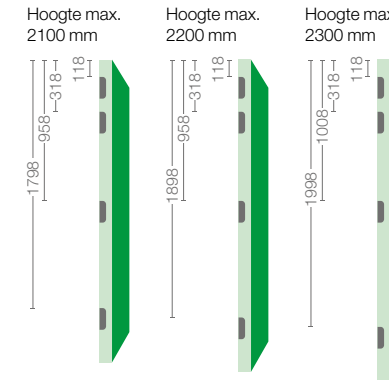

Voor hogere deuren zie pag 8

Belastingtabel

Staal

Type	Kg.	Aantal	Schroeflengte
1201-35	65	2	4,0 x 45 mm
	90	3	4,0 x 45 mm
	105	4	4,0 x 45 mm

Toepasbare draairichting

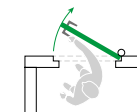

Artikelnummer	Materiaal/kleur/finish	Klein-verpakking	Groot-verpakking	Minimaal bestelaantal	Aanbevolen bevestiging
1201-35-23/V4E	staal Topcoat gegalvaniseerd	6	36	6	4,0 x 45 mm

Bijzonderheden:
/V4E = EAN sticker direct op product

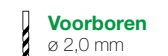

1202 VEILIGHEIDS KOGELSTIFTPAUMELLE

Toepassing

voor ver openslaande buitendeuren



TYPE 1202-27

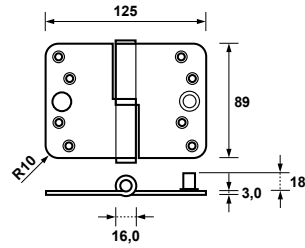

Productpositie

Deur

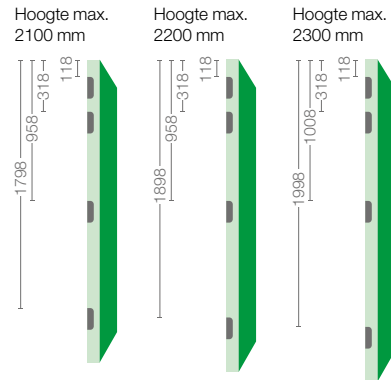

Voor hogere deuren zie pag 8

Belastingtabel

Staal

Type	Kg.	Aantal	Schroeflengte
1202-27	50	2	4,0 x 45 mm
	70	3	4,0 x 45 mm
	90	4	4,0 x 45 mm

RVS

Type	Kg.	Aantal	Schroeflengte
1202-27	50	2	4,0 x 45 mm
	70	3	4,0 x 45 mm
	90	4	4,0 x 45 mm

Toepasbare draairichting

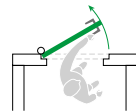

Artikelnummer	Materiaal/kleur/finish	Klein-verpakking	Groot-verpakking	Minimaal bestelaantal	Aanbevolen bevestiging
1202-27-23/V4E	staal Topcoat gegalvaniseerd	4	16	4	4,0 x 45 mm
1202-27-81/V4E	RVS geborsteld	4	16	4	4,0 x 45 mm

Bijzonderheden:
/V4E = EAN sticker direct op product

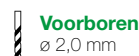

VEILIGHEIDS KOGELSTIFTPAUMELLE 1202

Toepassing

voor ver openslaande buitendeuren



TYPE 1202-28

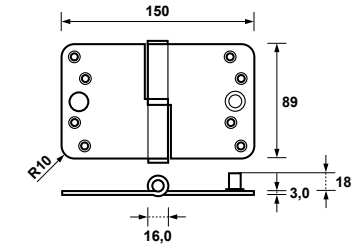

Productpositie

Deur

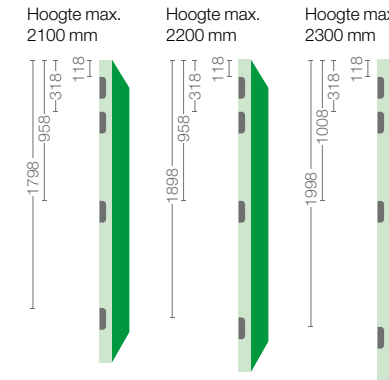

Voor hogere deuren zie pag 8

Belastingtabel

Staal

Type	Kg.	Aantal	Schroeflengte
1202-28	40	2	4,0 x 45 mm
	50	3	4,0 x 45 mm
	65	4	4,0 x 45 mm

Toepasbare draairichting

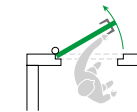

Artikelnummer	Materiaal/kleur/finish	Klein-verpakking	Groot-verpakking	Minimaal bestelaantal	Aanbevolen bevestiging
1202-28-23/V4	staal Topcoat gegalvaniseerd	4	16	4	4,0 x 45 mm

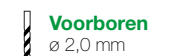

1202 VEILIGHEIDS KOGELSTIFTPAUMELLE

VEILIGHEIDS KOGELSTIFTPAUMELLE 1202

Toepassing

voor ver openslaande buitendeuren



TYPE 1202-37

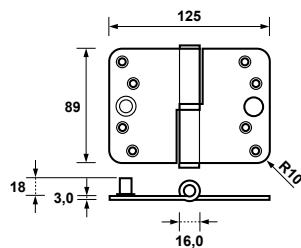

Toepassing

voor ver openslaande buitendeuren



TYPE 1202-38

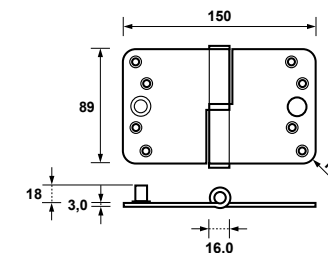

Productpositie

Deur

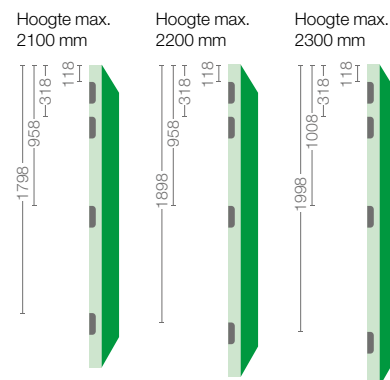

Belastingtabel

Staal

Type	Kg.	Aantal	Schroeflengte
1202-37	50	2	4,0 x 45 mm
	70	3	4,0 x 45 mm
	90	4	4,0 x 45 mm

RVS

Type	Kg.	Aantal	Schroeflengte
1202-37	50	2	4,0 x 45 mm
	70	3	4,0 x 45 mm
	90	4	4,0 x 45 mm

Productpositie

Deur

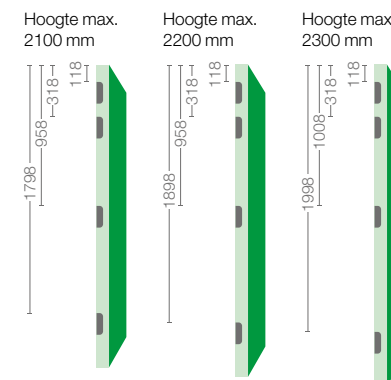

Belastingtabel

staal

Type	Kg.	Aantal	Schroeflengte
1202-38	40	2	4,0 x 45 mm
	50	3	4,0 x 45 mm
	65	4	4,0 x 45 mm

Voor hogere deuren zie pag 8

Voor hogere deuren zie pag 8

Toepasbare draairichting

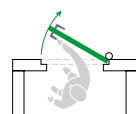

Toepasbare draairichting

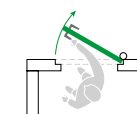

Artikelnummer	Materiaal/kleur/finish	Klein-verpakking	Groot-verpakking	Minimaal bestelaantal	Aanbevolen bevestiging
1202-37-23/V4E	staal Topcoat gegalvaniseerd	4	16	4	4,0 x 45 mm
1202-37-81/V4E	RVS geborsteld	4	16	4	4,0 x 45 mm

Bijzonderheden:
/V4E = EAN sticker direct op product



Artikelnummer	Materiaal/kleur/finish	Klein-verpakking	Groot-verpakking	Minimaal bestelaantal	Aanbevolen bevestiging
1202-38-23/V4	staal Topcoat gegalvaniseerd	4	16	4	4,0 x 45 mm



1203 KOGELSTIFTPAUMELLE



Toepassing
voor deuren



TYPE 1203-25

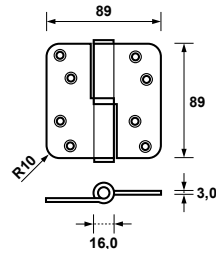

Productpositie

Deur

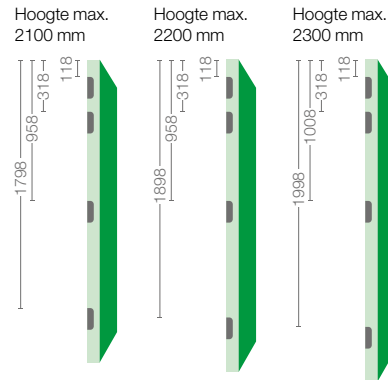

Voor hogere deuren zie pag 8

Belastingtabel

Staal

Type	Kg.	Aantal	Schroeflengte
1203-25	65	2	4,0 x 45 mm
	90	3	4,0 x 45 mm
	105	4	4,0 x 45 mm

RVS

Type	Kg.	Aantal	Schroeflengte
1203-25	65	2	4,0 x 45 mm
	90	3	4,0 x 45 mm
	105	4	4,0 x 45 mm

Toepasbare draairichting

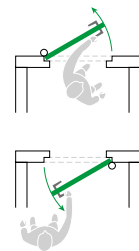

Artikelnummer	Materiaal/kleur/finish	Klein-verpakking	Groot-verpakking	Minimaal bestelaantal	Aanbevolen bevestiging
1203-25-23/E	staal Topcoat gegalvaniseerd	6	36	6	4,0 x 45 mm
1203-25-81/E	RVS geborsteld	6	36	6	4,0 x 45 mm

Bijzonderheden:
/E = EAN sticker direct op product



VEILIGHEIDS KOGELSTIFTPAUMELLE 1203



Toepassing
voor buitendeuren



TYPE 1203-25

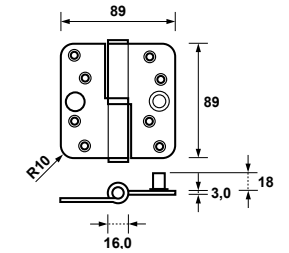

Productpositie

Deur

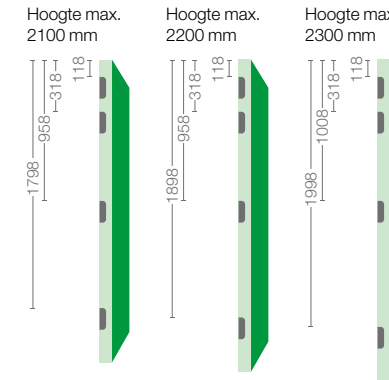

Voor hogere deuren zie pag 8

Belastingtabel

Staal

Type	Kg.	Aantal	Schroeflengte
1203-25	65	2	4,0 x 45 mm
	90	3	4,0 x 45 mm
	105	4	4,0 x 45 mm

RVS

Type	Kg.	Aantal	Schroeflengte
1203-25	65	2	4,0 x 45 mm
	90	3	4,0 x 45 mm
	105	4	4,0 x 45 mm

Toepasbare draairichting

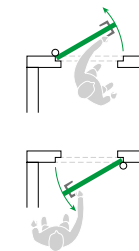

Artikelnummer	Materiaal/kleur/finish	Klein-verpakking	Groot-verpakking	Minimaal bestelaantal	Aanbevolen bevestiging
1203-25-23/V4E	staal Topcoat gegalvaniseerd	6	36	6	4,0 x 45 mm
1203-25-81/V4E	RVS geborsteld	6	36	6	4,0 x 45 mm

Bijzonderheden:
/V4E = EAN sticker direct op product



1203 KOGELSTIFTPAUMELLE



Toepassing
voor deuren



TYPE 1203-35

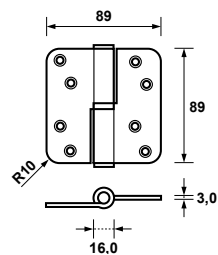

Productpositie

Deur

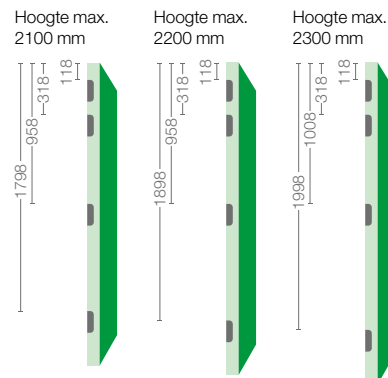

Voor hogere deuren zie pag 8

Belastingtabel

Staal

Type	Kg.	Aantal	Schroeflengte
1203-35	65	2	4,0 x 45 mm
	90	3	4,0 x 45 mm
	105	4	4,0 x 45 mm

RVS

Type	Kg.	Aantal	Schroeflengte
1203-35	65	2	4,0 x 45 mm
	90	3	4,0 x 45 mm
	105	4	4,0 x 45 mm

Toepasbare draairichting

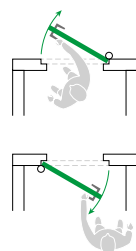

Artikelnummer	Materiaal/kleur/finish	Klein-verpakking	Groot-verpakking	Minimaal bestelaantal	Aanbevolen bevestiging
1203-35-23/E	staal Topcoat gegalvaniseerd	6	36	6	4,0 x 45 mm
1203-35-81/E	RVS geborsteld	6	36	6	4,0 x 45 mm

Bijzonderheden:
/E = EAN sticker direct op product



VEILIGHEIDS KOGELSTIFTPAUMELLE 1203



Toepassing
voor buitendeuren



TYPE 1203-35

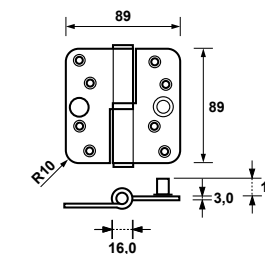

Productpositie

Deur

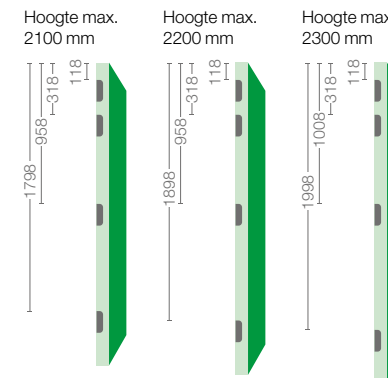

Voor hogere deuren zie pag 8

Belastingtabel

Staal

Type	Kg.	Aantal	Schroeflengte
1203-35	65	2	4,0 x 45 mm
	90	3	4,0 x 45 mm
	105	4	4,0 x 45 mm

RVS

Type	Kg.	Aantal	Schroeflengte
1203-35	65	2	4,0 x 45 mm
	90	3	4,0 x 45 mm
	105	4	4,0 x 45 mm

Toepasbare draairichting

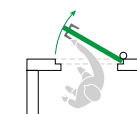

Artikelnummer	Materiaal/kleur/finish	Klein-verpakking	Groot-verpakking	Minimaal bestelaantal	Aanbevolen bevestiging
1203-35-23/V4E	staal Topcoat gegalvaniseerd	6	36	6	4,0 x 45 mm
1203-35-81/V4E	RVS geborsteld	6	36	6	4,0 x 45 mm

Bijzonderheden:
/V4E = EAN sticker direct op product



1531 KOGELLAGERSCHARNIER

Toepassing
voor ramen

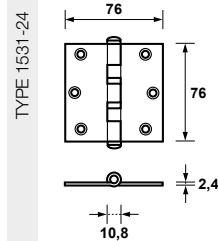

Productpositie

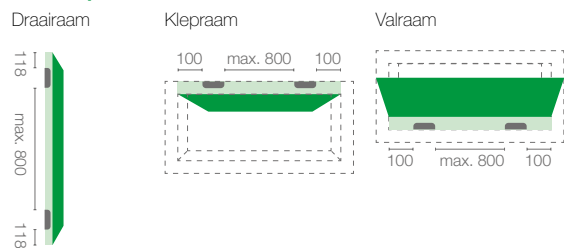

Belastingtabel

Staal				
Type	Kg.	Aantal	Schroeflengte	
1531-24	25	2	4,0 x 40 mm	
	35	3	4,0 x 40 mm	
	45	4	4,0 x 40 mm	

RVS				
Type	Kg.	Aantal	Schroeflengte	
1531-24	25	2	4,0 x 40 mm	
	35	3	4,0 x 40 mm	
	45	4	4,0 x 40 mm	

Toepasbare draairichting

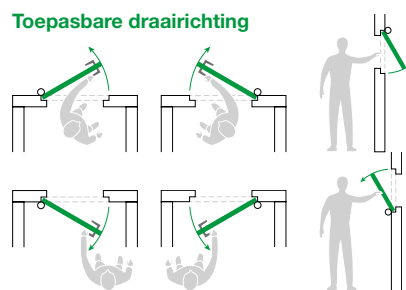

Artikelnummer	Materiaal/kleur/finish	Klein-verpakking	Groot-verpakking	Minimaal bestelaantal	Aanbevolen bevestiging
1531-24-23/E	staal Topcoat gegalvaniseerd	6	48	6	4,0 x 40 mm
1531-24-81/E	RVS geborsteld	6	48	6	4,0 x 40 mm

Bijzonderheden:
/E = EAN sticker direct op product



KOGELLAGERSCHARNIER 1531

Toepassing
voor ramen en deuren

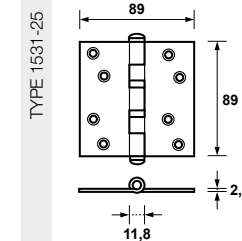

Productpositie

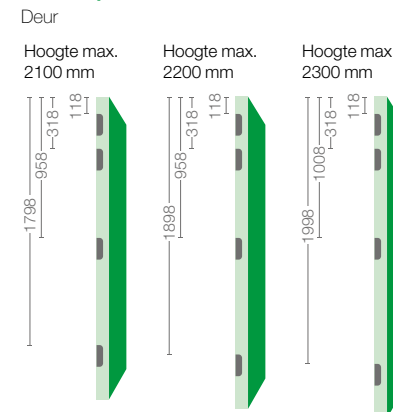

Belastingtabel

Staal				
Type	Kg.	Aantal	Schroeflengte	
1531-25	50	2	4,0 x 40 mm	
	65	3	4,0 x 40 mm	
	80	4	4,0 x 40 mm	

RVS				
Type	Kg.	Aantal	Schroeflengte	
1531-25	50	2	4,0 x 40 mm	
	65	3	4,0 x 40 mm	
	80	4	4,0 x 40 mm	

Voor hogere deuren zie pag 8

Toepasbare draairichting

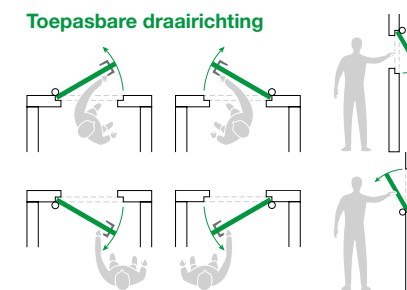

Artikelnummer	Materiaal/kleur/finish	Klein-verpakking	Groot-verpakking	Minimaal bestelaantal	Aanbevolen bevestiging
1531-25-23/E	staal Topcoat gegalvaniseerd	6	72	6	4,0 x 40 mm
1531-25-81/E	RVS geborsteld	6	72	6	4,0 x 40 mm

Bijzonderheden:
/E = EAN sticker direct op product



1531 KOGELLAGERSCHARNIER



Toepassing
voor ramen en deuren

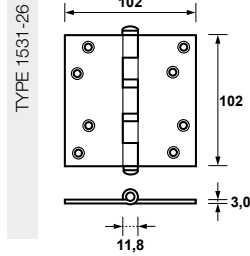

Productpositie

Deur

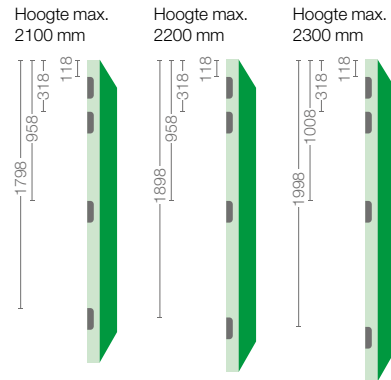

Belastingtabel

Staal

Type	Kg.	Aantal	Schroeflengte
1531-26	50	2	4,0 x 45 mm
	70	3	4,0 x 45 mm
	80	4	4,0 x 45 mm

RVS

Type	Kg.	Aantal	Schroeflengte
1531-26	50	2	4,0 x 45 mm
	70	3	4,0 x 45 mm
	80	4	4,0 x 45 mm

Voor hogere deuren zie pag 8

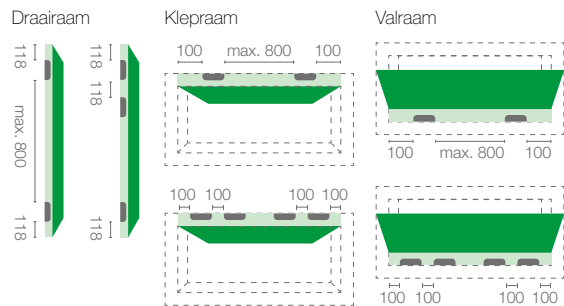

Toepasbare draairichting

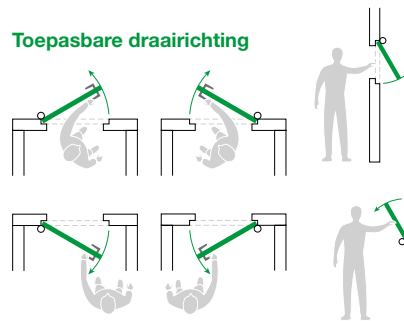

Artikelnummer	Materiaal/kleur/finish	Klein-verpakking	Groot-verpakking	Minimaal bestelaantal	Aanbevolen bevestiging
1531-26-23/E	staal Topcoat gegalvaniseerd	6	36	6	4,0 x 45 mm
1531-26-81/E	RVS geborsteld	6	36	6	4,0 x 45 mm

Bijzonderheden:
/E = EAN sticker direct op product



KOGELLAGERSCHARNIER 1533



Toepassing
voor ramen

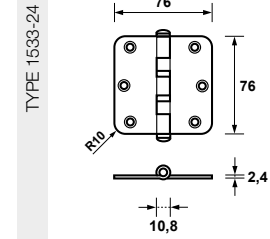

Productpositie

Draairaam

Klepraam

Valraam

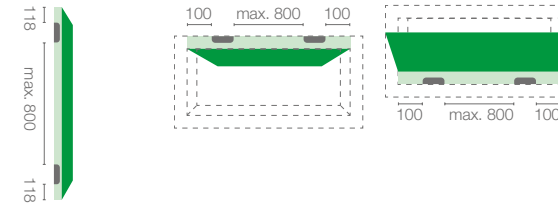

Belastingtabel

Staal

Type	Kg.	Aantal	Schroeflengte
1533-24	25	2	4,0 x 40 mm
	35	3	4,0 x 40 mm
	45	4	4,0 x 40 mm

Toepasbare draairichting

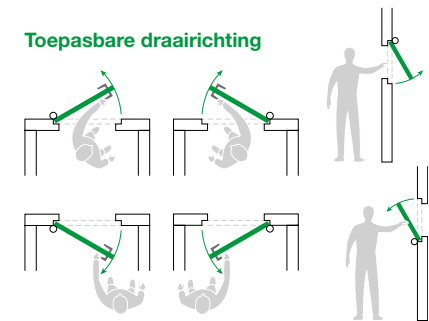

Artikelnummer	Materiaal/kleur/finish	Klein-verpakking	Groot-verpakking	Minimaal bestelaantal	Aanbevolen bevestiging
1533-24-23/E	staal Topcoat gegalvaniseerd	6	48	6	4,0 x 40 mm

Bijzonderheden:
/E = EAN sticker direct op product



1533 KOGELLAGERSCHARNIER



Toepassing
voor ramen en deuren



TYPE 1533-25

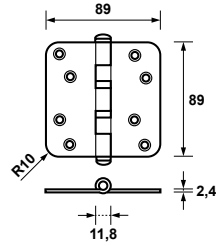

Productpositie

Deur

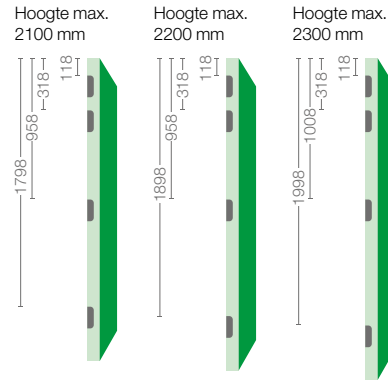

Voor hogere deuren zie pag 8

Belastingtabel

Staal

Type	Kg.	Aantal	Schroeflengte
1533-25	50	2	4,0 x 40 mm
	65	3	4,0 x 40 mm
	80	4	4,0 x 40 mm

RVS

Type	Kg.	Aantal	Schroeflengte
1533-25	50	2	4,0 x 40 mm
	65	3	4,0 x 40 mm
	80	4	4,0 x 40 mm

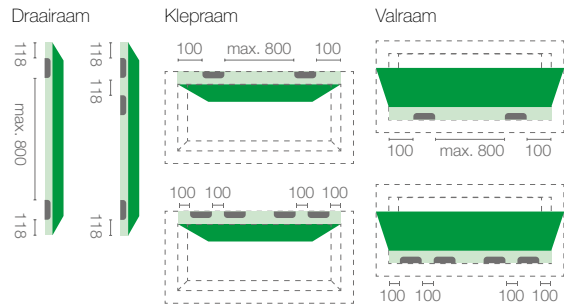

Toepasbare draairichting

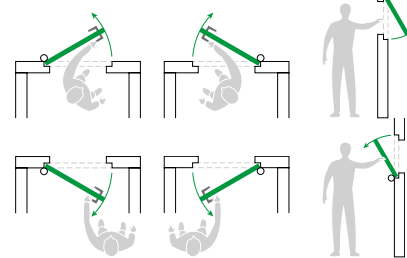

Artikelnummer	Materiaal/kleur/finish	Klein-verpakking	Groot-verpakking	Minimaal bestelaantal	Aanbevolen bevestiging
1533-25-23/E	staal Topcoat gegalvaniseerd	6	72	6	4,0 x 40 mm
1533-25-23/7	staal Topcoat gegalvaniseerd	-	50	50	4,0 x 40 mm
1533-25-81/E	RVS geborsteld	6	72	6	4,0 x 40 mm

Bijzonderheden:
/E = EAN sticker direct op product | /7 = los gestort



VEILIGHEIDS KOGELLAGERSCHARNIER 1541



Toepassing
voor ramen



TYPE 1541-24

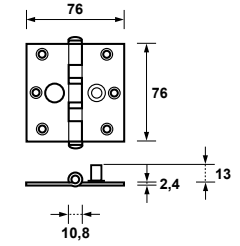

Productpositie

Draairaam

Klepraam

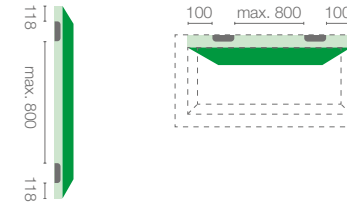

Belastingtabel

Staal

Type	Kg.	Aantal	Schroeflengte
1541-24	25	2	4,0 x 40 mm
	35	3	4,0 x 40 mm
	45	4	4,0 x 40 mm

RVS

Type	Kg.	Aantal	Schroeflengte
1541-24	25	2	4,0 x 40 mm
	35	3	4,0 x 40 mm
	45	4	4,0 x 40 mm

Toepasbare draairichting

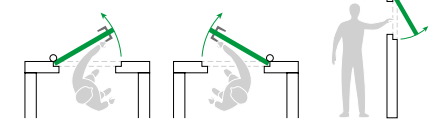

Artikelnummer	Materiaal/kleur/finish	Klein-verpakking	Groot-verpakking	Minimaal bestelaantal	Aanbevolen bevestiging
1541-24-23/VE	staal Topcoat gegalvaniseerd	6	48	6	4,0 x 40 mm
1541-24-81/VE	RVS geborsteld	6	48	6	4,0 x 40 mm

Bijzonderheden:
/VE = EAN sticker direct op product

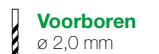

1541 VEILIGHEIDS KOGELLAGERSCHARNIER



Toepassing
voor ramen en buitendeuren

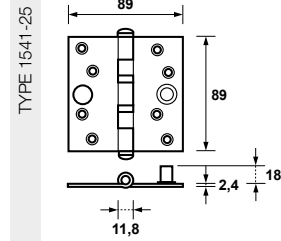

Productpositie

Deur

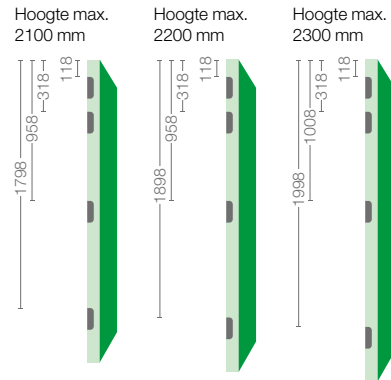

Voor hogere deuren zie pag 8

Belastingtabel

Staal

Type	Kg.	Aantal	Schroeflengte
1541-25	50	2	4,0 x 40 mm
	65	3	4,0 x 40 mm
	80	4	4,0 x 40 mm

RVS

Type	Kg.	Aantal	Schroeflengte
1541-25	50	2	4,0 x 40 mm
	65	3	4,0 x 40 mm
	80	4	4,0 x 40 mm

Toepasbare draairichting

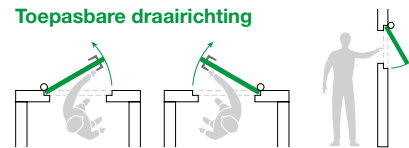

Draairaam

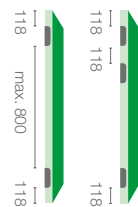

Klepraam

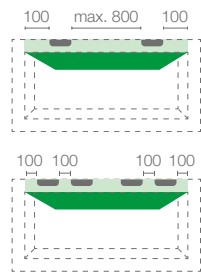

Artikelnummer	Materiaal/kleur/finish	Klein-verpakking	Groot-verpakking	Minimaal bestelaantal	Aanbevolen bevestiging
1541-25-23/V4E	staal Topcoat gegalvaniseerd	6	48	6	4,0 x 40 mm
1541-25-81/V4E	RVS geborsteld	6	48	6	4,0 x 40 mm

Bijzonderheden:
/V4E = EAN sticker direct op product



VEILIGHEIDS KOGELLAGERSCHARNIER 1543



Toepassing
voor ramen

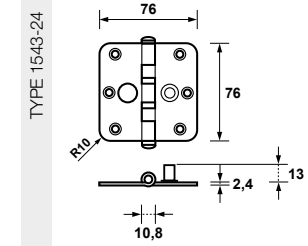

Productpositie

Draairaam



Klepraam

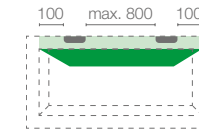

Belastingtabel

Staal

Type	Kg.	Aantal	Schroeflengte
1543-24	25	2	4,0 x 40 mm
	35	3	4,0 x 40 mm
	45	4	4,0 x 40 mm

RVS

Type	Kg.	Aantal	Schroeflengte
1543-24	25	2	4,0 x 40 mm
	35	3	4,0 x 40 mm
	45	4	4,0 x 40 mm

Toepasbare draairichting

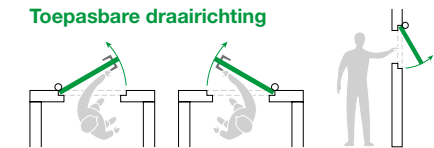

Artikelnummer	Materiaal/kleur/finish	Klein-verpakking	Groot-verpakking	Minimaal bestelaantal	Aanbevolen bevestiging
1543-24-23/VE	staal Topcoat gegalvaniseerd	6	48	6	4,0 x 40 mm
1543-24-81/VE	RVS geborsteld	6	48	6	4,0 x 40 mm

Bijzonderheden:
/VE = EAN sticker direct op product

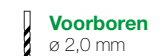

1543 VEILIGHEIDS KOGELLAGERSCHARNIER

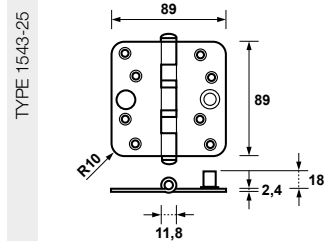

Productpositie

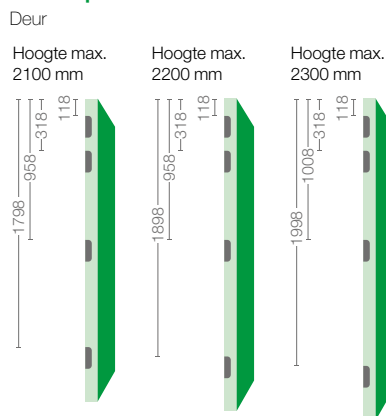

Belastingtabel

Staal				
Type	Kg.	Aantal	Schroeflengte	
1543-25	50	2	4,0 x 40 mm	
	65	3	4,0 x 40 mm	
	80	4	4,0 x 40 mm	
RVS				
Type	Kg.	Aantal	Schroeflengte	
1543-25	50	2	4,0 x 40 mm	
	65	3	4,0 x 40 mm	
	80	4	4,0 x 40 mm	

Voor hogere deuren zie pag 8

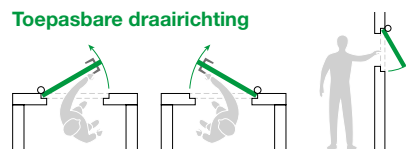
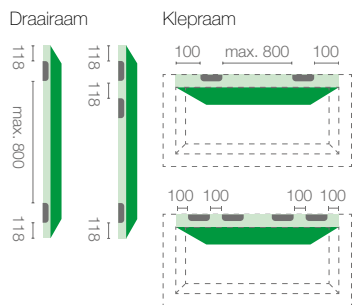

Artikelnummer	Materiaal/kleur/finish	Klein-verpakking	Groot-verpakking	Minimaal bestelaantal	Aanbevolen bevestiging
1543-25-23/V4E	staal Topcoat gegalvaniseerd	6	48	6	4,0 x 40 mm
1543-25-23/7V4	staal Topcoat gegalvaniseerd		50	50	4,0 x 40 mm
1543-25-81/V4E	RVS geborsteld	6	48	6	4,0 x 40 mm

Bijzonderheden:
/7 = los gestort | /E = EAN sticker direct op product



VEILIGHEIDS KOGELLAGERSCHARNIER 1543

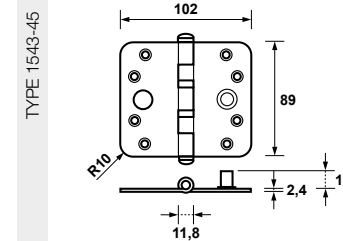

Productpositie



Belastingtabel

Staal				
Type	Kg.	Aantal	Schroeflengte	
1543-45	50	2	4,0 x 40 mm	
	70	3	4,0 x 40 mm	
	80	4	4,0 x 40 mm	
RVS				
Type	Kg.	Aantal	Schroeflengte	
1543-45	50	2	4,0 x 40 mm	
	70	3	4,0 x 40 mm	
	80	4	4,0 x 40 mm	

Voor hogere deuren zie pag 8

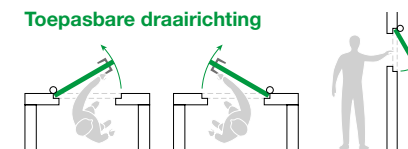
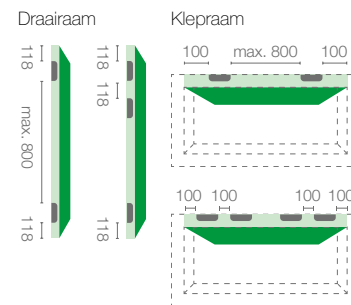

Artikelnummer	Materiaal/kleur/finish	Klein-verpakking	Groot-verpakking	Minimaal bestelaantal	Aanbevolen bevestiging
1543-45-23/V4E	staal Topcoat gegalvaniseerd	6	48	6	4,0 x 40 mm
1543-45-23/7V4	staal Topcoat gegalvaniseerd		50	50	4,0 x 40 mm

Bijzonderheden:
/V4E = EAN sticker direct op product



1607 SMART ONGELAGERD SCHARNIER

Toepassing

voor ramen en deuren



TYPE 1607-08

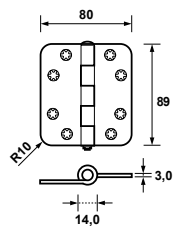

Productpositie

Deur

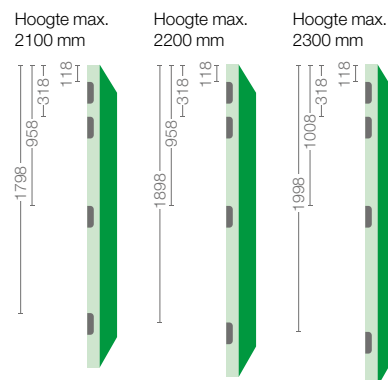

Belastingtabel

Staal

Type	Kg.	Aantal	Schroeflengte
1607-08	60	2	4,5 x 30 mm
	65	2	4,5 x 40 mm
	75	3	4,5 x 30 mm
	80	3	4,5 x 40 mm
	95	4	4,5 x 30 mm
	100	4	4,5 x 40 mm

Voor hogere deuren zie pag 8

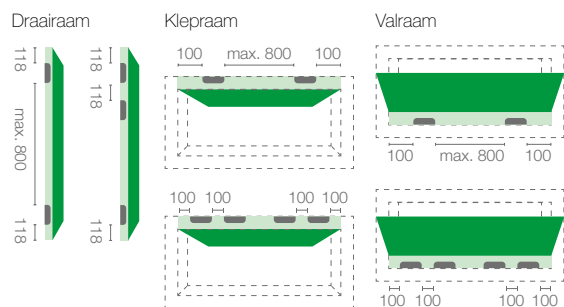

Toepasbare draairichting

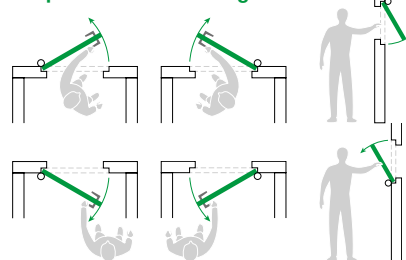

Artikelnummer	Materiaal/kleur/finish	Klein-verpakking	Groot-verpakking	Minimaal bestelaantal	Aanbevolen bevestiging
1607-08-23/7	staal Topcoat gegalvaniseerd	-	50	50	4,5 x 30 mm / 4,5 x 40 mm

Bijzonderheden:
/7 = los gestort



SMART ONGELAGERD SCHARNIER 1607

Toepassing

voor ramen en deuren



TYPE 1607-09

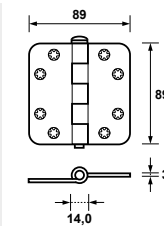

Productpositie

Deur

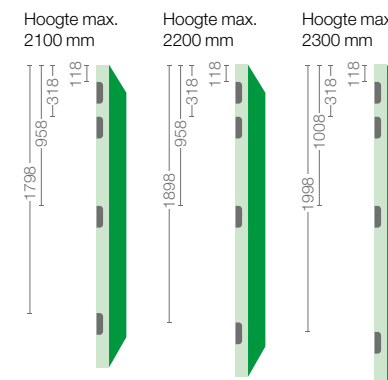

Belastingtabel

Staal

Type	Kg.	Aantal	Schroeflengte
1607-09	60	2	4,5 x 30 mm
	65	2	4,5 x 40 mm
	75	3	4,5 x 30 mm
	80	3	4,5 x 40 mm
	95	4	4,5 x 30 mm
	100	4	4,5 x 40 mm

Voor hogere deuren zie pag 8

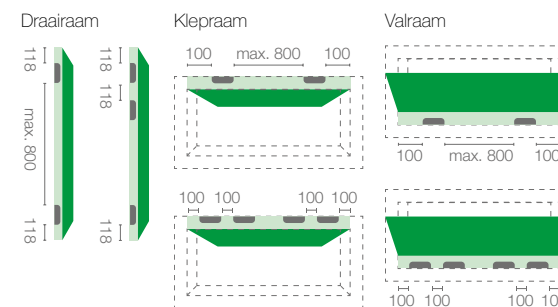

Toepasbare draairichting

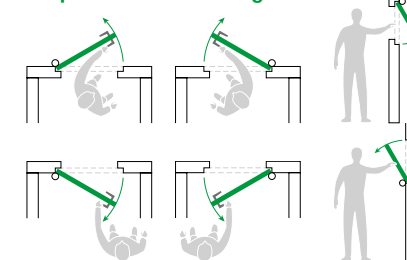

Artikelnummer	Materiaal/kleur/finish	Klein-verpakking	Groot-verpakking	Minimaal bestelaantal	Aanbevolen bevestiging
1607-09-23/E	staal Topcoat gegalvaniseerd	6	48	6	4,5 x 30 mm / 4,5 x 40 mm
1607-09-23/7	staal Topcoat gegalvaniseerd	-	50	50	4,5 x 30 mm / 4,5 x 40 mm

Bijzonderheden:
/E = EAN sticker direct op product | /7 = los gestort



1617 SMART ONGELAGERD VEILIGHEIDSSCHARNIER

Toepassing

voor ramen en buitendeuren



TYPE 1617-08

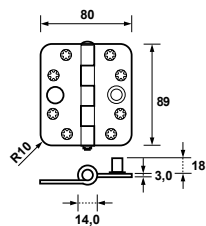

Productpositie

Deur

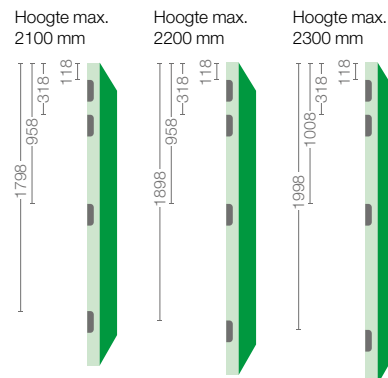

Voor hogere deuren zie pag 8

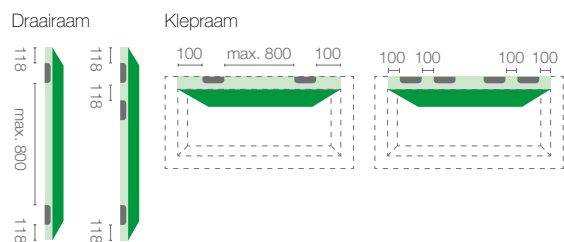

Belastingtabel

Staal

Type	Kg.	Aantal	Schroeflengte
1617-08-23	60	2	4,5 x 30 mm
	65	2	4,5 x 40 mm
	75	3	4,5 x 30 mm
	80	3	4,5 x 40 mm
	95	4	4,5 x 30 mm
	100	4	4,5 x 40 mm

RVS

Type	Kg.	Aantal	Schroeflengte
1617-08-81	50	2	4,5 x 30 mm
	55	2	4,5 x 40 mm
	65	3	4,5 x 30 mm
	70	3	4,5 x 40 mm
	85	4	4,5 x 30 mm
	90	4	4,5 x 40 mm

Toepasbare draairichting

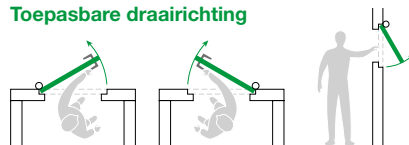

Artikelnummer	Materiaal/kleur/finish	Klein-verpakking	Groot-verpakking	Minimaal bestelaantal	Aanbevolen bevestiging
1617-08-23/7V	staal Topcoat gegalvaniseerd	-	50	50	4,5 x 30 mm / 4,5 x 40 mm
1617-08-81/VE	RVS geborsteld	6	24	6	4,5 x 30 mm / 4,5 x 40 mm

Bijzonderheden:
/7 = los gestort | /E = EAN sticker direct op product



SMART ONGELAGERD VEILIGHEIDSSCHARNIER 1617

Toepassing

voor ramen en buitendeuren



TYPE 1617-09

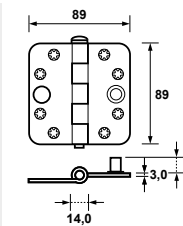

Productpositie

Deur

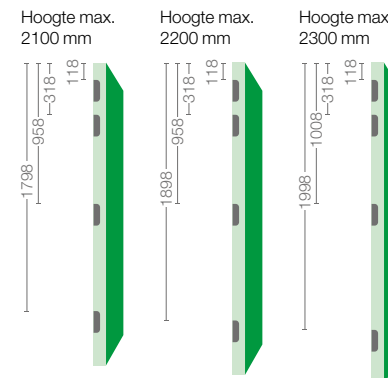

Voor hogere deuren zie pag 8

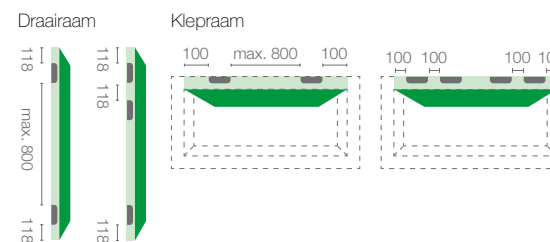

Belastingtabel

Staal

Type	Kg.	Aantal	Schroeflengte
1617-09-23	60	2	4,5 x 30 mm
	65	2	4,5 x 40 mm
	75	3	4,5 x 30 mm
	80	3	4,5 x 40 mm
	95	4	4,5 x 30 mm
	100	4	4,5 x 40 mm

RVS

Type	Kg.	Aantal	Schroeflengte
1617-09-81	50	2	4,5 x 30 mm
	55	2	4,5 x 40 mm
	65	3	4,5 x 30 mm
	70	3	4,5 x 40 mm
	85	4	4,5 x 30 mm
	90	4	4,5 x 40 mm

Toepasbare draairichting

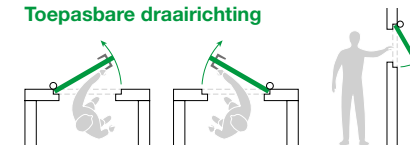

Artikelnummer	Materiaal/kleur/finish	Klein-verpakking	Groot-verpakking	Minimaal bestelaantal	Aanbevolen bevestiging
1617-09-23/VE	staal Topcoat gegalvaniseerd	6	48	6	4,5 x 30 mm / 4,5 x 40 mm
1617-09-23/7V	staal Topcoat gegalvaniseerd	-	50	50	4,5 x 30 mm / 4,5 x 40 mm
1617-09-81/VE	RVS geborsteld	6	48	6	4,5 x 30 mm / 4,5 x 40 mm

Bijzonderheden:
/E = EAN sticker direct op product | /7 = los gestort



1637 SMART SCHIJFLAGERSCHARNIER



Toepassing
voor ramen en deuren

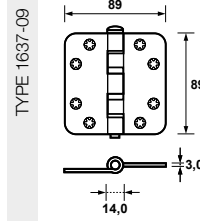

Productpositie

Deur

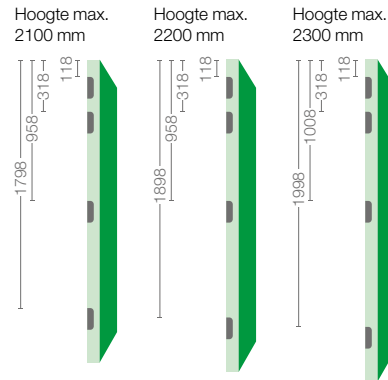

Voor hogere deuren zie pag 8

Belastingtabel

Type	Kg.	Aantal	Schroeflengte
1617-09	70	2	4,5 x 30 mm
	80	2	4,5 x 40 mm
	90	3	4,5 x 30 mm
	105	3	4,5 x 40 mm
	110	4	4,5 x 30 mm
	125	4	4,5 x 40 mm

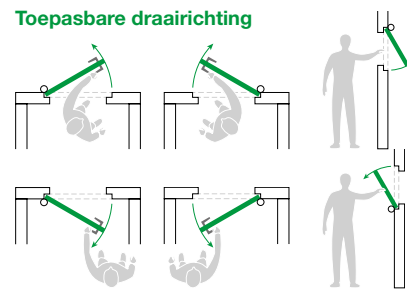

Toepasbare draairichting

Artikelnummer	Materiaal/kleur/finish	Klein-verpakking	Groot-verpakking	Minimaal bestelaantal	Aanbevolen bevestiging
1637-09-23/E	staal Topcoat gegalvaniseerd	6	48	6	4,5 x 30 mm / 4,5 x 40 mm
1637-09-23/7	staal Topcoat gegalvaniseerd	-	50	50	4,5 x 30 mm / 4,5 x 40 mm
1637-09-81/E	RVS geborsteld	6	48	6	4,5 x 30 mm / 4,5 x 40 mm

Bijzonderheden:
/E = EAN sticker direct op product | /7 = los gestort



SMART VEILIGHEIDS SCHIJFLAGERSCHARNIER 1647



Toepassing
voor ramen en buitendeuren

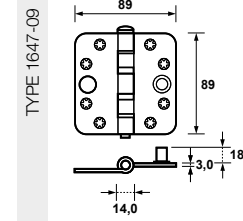

Productpositie

Deur

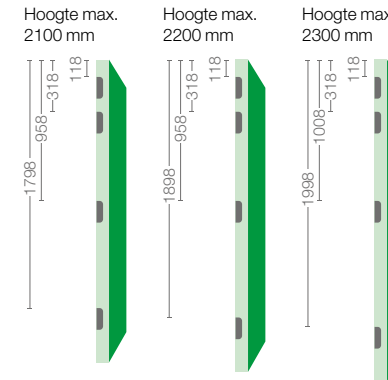

Voor hogere deuren zie pag 8

Belastingtabel

Type	Kg.	Aantal	Schroeflengte
1647-09	70	2	4,5 x 30 mm
	80	2	4,5 x 40 mm
	90	3	4,5 x 30 mm
	105	3	4,5 x 40 mm
	110	4	4,5 x 30 mm
	125	4	4,5 x 40 mm

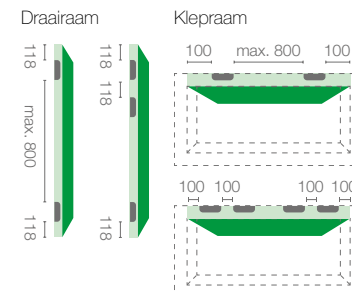

Toepasbare draairichting

Artikelnummer	Materiaal/kleur/finish	Klein-verpakking	Groot-verpakking	Minimaal bestelaantal	Aanbevolen bevestiging
1647-09-23/VE	staal Topcoat gegalvaniseerd	6	48	6	4,5 x 30 mm / 4,5 x 40 mm
1647-09-23/7V	staal Topcoat gegalvaniseerd	-	50	50	4,5 x 30 mm / 4,5 x 40 mm
1647-09-81/VE	RVS geborsteld	6	48	6	4,5 x 30 mm / 4,5 x 40 mm

Bijzonderheden:
/E = EAN sticker direct op product | /7 = los gestort

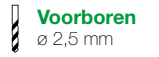

1647 SMART VEILIGHEIDS SCHIJFLAGERSCHARNIER



Toepassing

voor ver openslaande ramen en buitendeuren



TYPE 1647-15

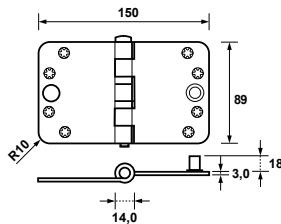

Productpositie

Deur

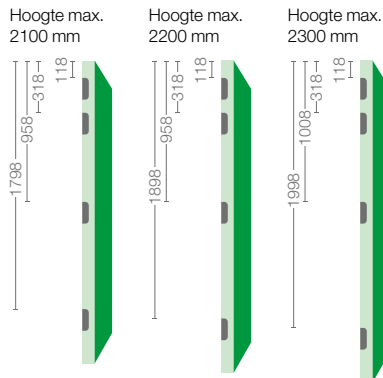

Voor hogere deuren zie pag 8

Belastingtabel

Type	Kg.	Aantal	Schroeflengte
1647-15	50	2	4,5 x 30 mm
	60	3	4,5 x 30 mm
	70	4	4,5 x 30 mm

Draairaam

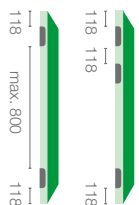

Toepasbare draairichting

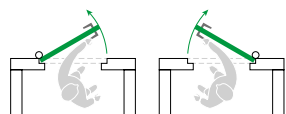

Artikelnummer	Materiaal/kleur/finish	Klein-verpakking	Groot-verpakking	Minimaal bestelaantal	Aanbevolen bevestiging
1647-15-23/VE	staal Topcoat gegalvaniseerd	4	16	4	4,5 x 30 mm / 4,5 x 40 mm
1647-15-23/7V	staal Topcoat gegalvaniseerd	-	25	25	4,5 x 30 mm / 4,5 x 40 mm
1647-15-81/VE	RVS geborsteld	4	16	4	4,5 x 30 mm / 4,5 x 40 mm

Bijzonderheden:
/VE = EAN sticker direct op product | /7V = los gestort



SMART KOGELLAGERSCHARNIER 1657



Toepassing

voor ramen en deuren



TYPE 1657-09

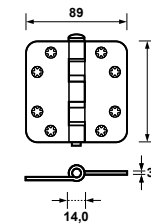

Productpositie

Deur

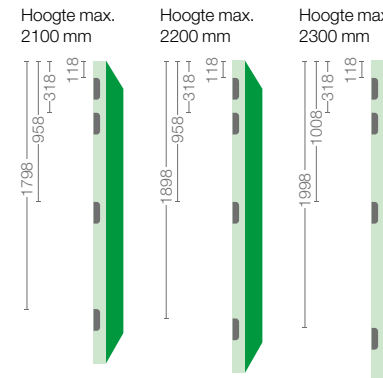

Voor hogere deuren zie pag 8

Belastingtabel

Type	Kg.	Aantal	Schroeflengte
1657-09	65	2	4,5 x 30 mm
	70	2	4,5 x 40 mm
	80	3	4,5 x 30 mm
	85	3	4,5 x 40 mm
	100	4	4,5 x 30 mm
	105	4	4,5 x 40 mm

Draairaam

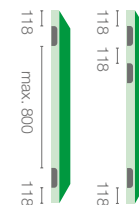

Klepraam

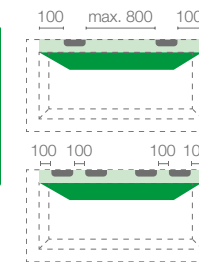

Valraam

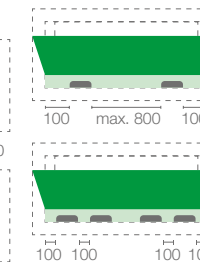

Toepasbare draairichting

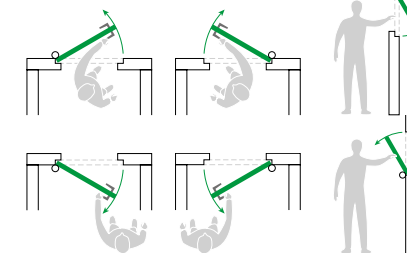

Artikelnummer	Materiaal/kleur/finish	Klein-verpakking	Groot-verpakking	Minimaal bestelaantal	Aanbevolen bevestiging
1657-09-23/E	staal Topcoat gegalvaniseerd	6	48	6	4,5 x 30 mm / 4,5 x 40 mm
1657-09-23/7	staal Topcoat gegalvaniseerd	-	50	50	4,5 x 30 mm / 4,5 x 40 mm
1657-09-81/E	RVS geborsteld	6	48	6	4,5 x 30 mm / 4,5 x 40 mm

Bijzonderheden:
/E = EAN sticker direct op product | /7 = los gestort



1667 SMART VEILIGHEIDS KOGELLAGERSCHARNIER



Productpositie

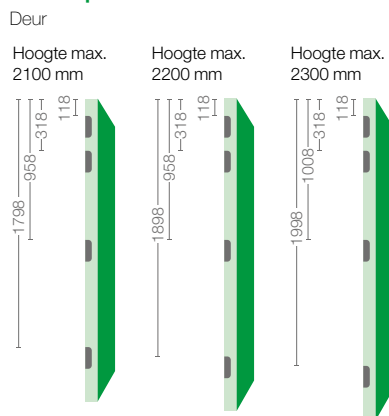

Belastingtabel

Type	Kg.	Aantal	Schroeflengte
1667-09	65	2	4,5 x 30 mm
	70	2	4,5 x 40 mm
	80	3	4,5 x 30 mm
	85	3	4,5 x 40 mm
	100	4	4,5 x 30 mm
	105	4	4,5 x 40 mm

Voor hogere deuren zie pag 8

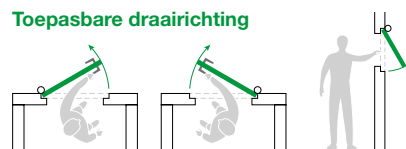
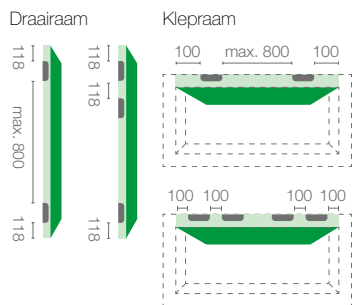

Artikelnummer	Materiaal/kleur/finish	Klein-verpakking	Groot-verpakking	Minimaal bestelaantal	Aanbevolen bevestiging
1667-09-23/VE	staal Topcoat gegalvaniseerd	6	48	6	4,5 x 30 mm / 4,5 x 40 mm
1667-09-23/7V	staal Topcoat gegalvaniseerd	-	50	50	4,5 x 30 mm / 4,5 x 40 mm

Bijzonderheden:
/VE = EAN sticker direct op product | /7V = los gestort



SMART EASYFIX SCHARNIER 1677



Productpositie

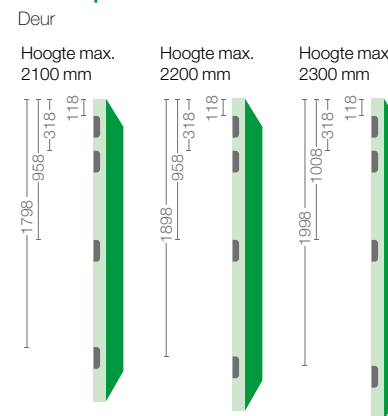

Belastingtabel

Type	Kg.	Aantal	Schroeflengte
1677-09	75	2	4,5 x 30 mm
	85	2	4,5 x 40 mm
	100	3	4,5 x 30 mm
	125	3	4,5 x 40 mm
	120	4	4,5 x 30 mm
	145	4	4,5 x 40 mm

Voor hogere deuren zie pag 8

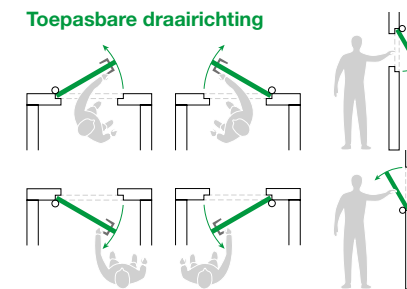
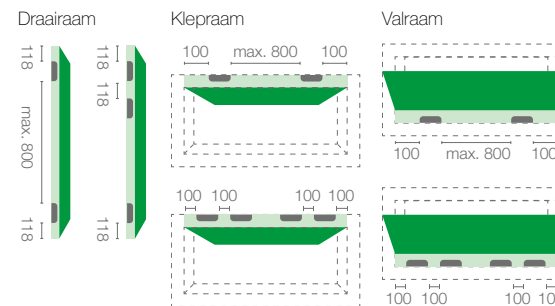

Artikelnummer	Materiaal/kleur/finish	Klein-verpakking	Groot-verpakking	Minimaal bestelaantal	Aanbevolen bevestiging
1677-09-23/E	staal Topcoat gegalvaniseerd	6	48	6	4,5 x 30 mm / 4,5 x 40 mm
1677-09-23/7	staal Topcoat gegalvaniseerd	-	50	50	4,5 x 30 mm / 4,5 x 40 mm
1677-09-81/E	RVS geborsteld	6	48	6	4,5 x 30 mm / 4,5 x 40 mm
1677-09-83/7	RVS gestraald	-	50	50	4,5 x 30 mm / 4,5 x 40 mm

Bijzonderheden:
/E = EAN sticker direct op product | /7 = los gestort



1686 SMART EASYFIX VEILIGHEIDSSCHARNIER



Toepassing
voor ramen en buitendeuren



TYPE 1686-09

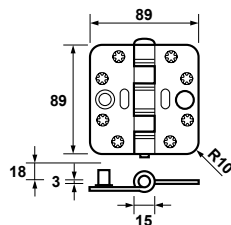

Productpositie

Deur

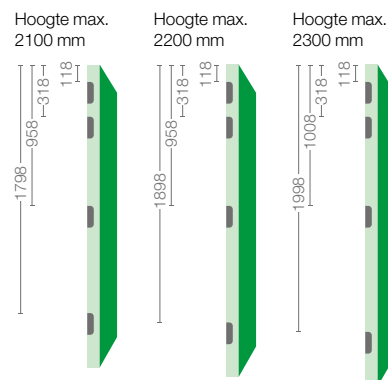

Voor hogere deuren zie pag 8

Belastingtabel

Type	Kg.	Aantal	Schroeflengte
1686-09	75	2	4,5 x 30 mm
	85	2	4,5 x 40 mm
	100	3	4,5 x 30 mm
	125	3	4,5 x 40 mm
	120	4	4,5 x 30 mm
	145	4	4,5 x 40 mm

Draairaam

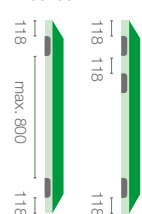

Klepraam

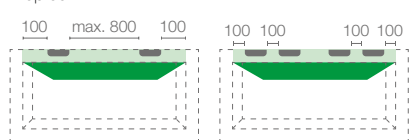

Toepasbare draairichting



Artikelnummer	Materiaal/kleur/finish	Klein-verpakking	Groot-verpakking	Minimaal bestelaantal	Aanbevolen bevestiging
1686-09-23/7V*	staal Topcoat gegalvaniseerd	-	50	50	4,5 x 30 mm / 4,5 x 40 mm

Bijzonderheden:
/7V = los gestort | * = ingebouwde dievenklauw op kozijnbleed ipv deurbleed



SMART EASYFIX VEILIGHEIDSSCHARNIER 1687



Toepassing
voor ramen en buitendeuren



TYPE 1687-09

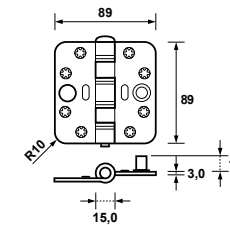

Productpositie

Deur

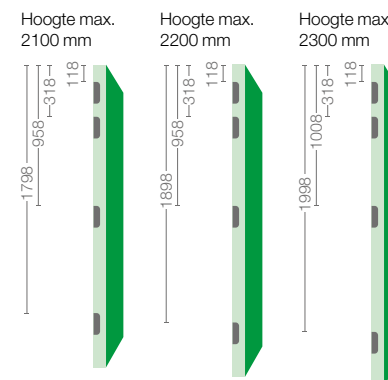

Voor hogere deuren zie pag 8

Belastingtabel

Type	Kg.	Aantal	Schroeflengte
1687-09	75	2	4,5 x 30 mm
	85	2	4,5 x 40 mm
	100	3	4,5 x 30 mm
	125	3	4,5 x 40 mm
	120	4	4,5 x 30 mm
	145	4	4,5 x 40 mm

Draairaam

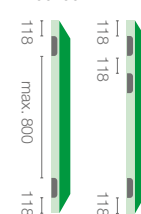

Klepraam

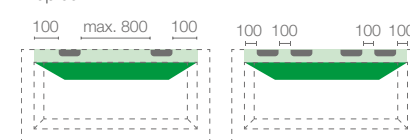

Toepasbare draairichting

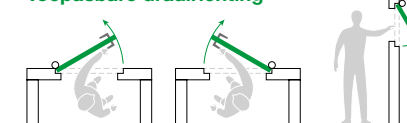

Artikelnummer	Materiaal/kleur/finish	Klein-verpakking	Groot-verpakking	Minimaal bestelaantal	Aanbevolen bevestiging
1687-09-23/VE	staal Topcoat gegalvaniseerd	6	48	6	4,5 x 30 mm / 4,5 x 40 mm
1687-09-23/7V	staal Topcoat gegalvaniseerd	-	50	50	4,5 x 30 mm / 4,5 x 40 mm
1687-09-23/71V	staal Xtremecoat gegalvaniseerd	-	50	50	4,5 x 30 mm / 4,5 x 40 mm
1687-09-81/VE	RVS geborsteld	6	48	6	4,5 x 30 mm / 4,5 x 40 mm
1687-09-83/7V	RVS gestraald	-	50	50	4,5 x 30 mm / 4,5 x 40 mm

Bijzonderheden:
/VE = EAN sticker direct op product | /7V = los gestort



1687 SMART EASYFIX VEILIGHEIDSSCHARNIER

Toepassing

voor ramen en buitendeuren



TYPE 1687-10

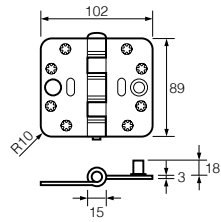

Productpositie

Deur

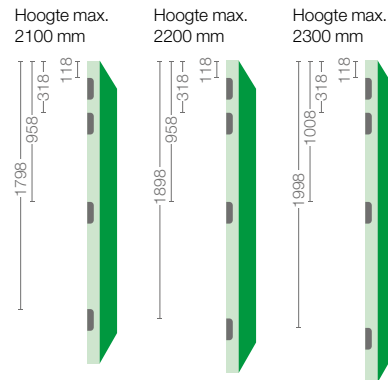

Voor hogere deuren zie pag 8

Belastingtabel

Type	Kg.	Aantal	Schroeflengte
1687-10	100	3	4,5 x 40 mm
	120	4	4,5 x 40 mm

Draairaam

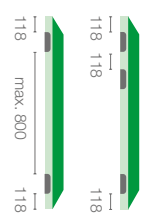

Klepraam

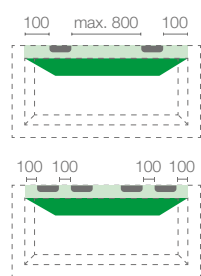

Toepasbare draairichting

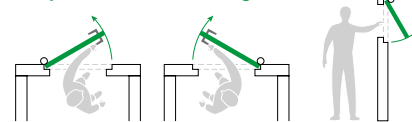

Artikelnummer	Materiaal/kleur/finish	Klein-verpakking	Groot-verpakking	Minimaal bestelaantal	Aanbevolen bevestiging
1687-10-23/VE	staal Topcoat gegalvaniseerd	4	16	4	4,5 x 40 mm
1687-10-23/7V	staal Topcoat gegalvaniseerd	-	50	50	4,5 x 40 mm

Bijzonderheden:
/7V = los gestort | /VE = EAN sticker direct op product



SMART EASYFIX VEILIGHEIDSSCHARNIER 1687

Toepassing

voor ramen en buitendeuren



TYPE 1687-12

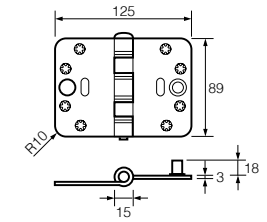

Productpositie

Deur



Voor hogere deuren zie pag 8

Belastingtabel

Type	Kg.	Aantal	Schroeflengte
1687-12	80	3	4,5 x 40 mm
	90	4	4,5 x 40 mm

Draairaam

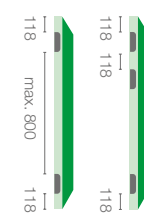

Klepraam

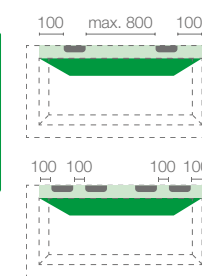

Toepasbare draairichting

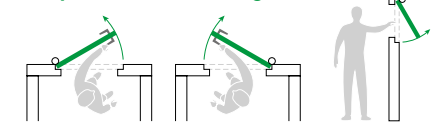

Artikelnummer	Materiaal/kleur/finish	Klein-verpakking	Groot-verpakking	Minimaal bestelaantal	Aanbevolen bevestiging
1687-12-23/VE	staal Topcoat gegalvaniseerd	4	16	4	4,5 x 40 mm
1687-12-23/7V	staal Topcoat gegalvaniseerd	-	50	50	4,5 x 40 mm

Bijzonderheden:
/VE = EAN sticker direct op product | /7V = los gestort



1687 SMART EASYFIX VEILIGHEIDSSCHARNIER



Toepassing

voor ver openslaande ramen en buitendeuren



TYPE 1687-15

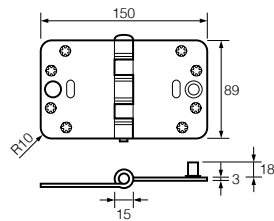

Productpositie

Deur

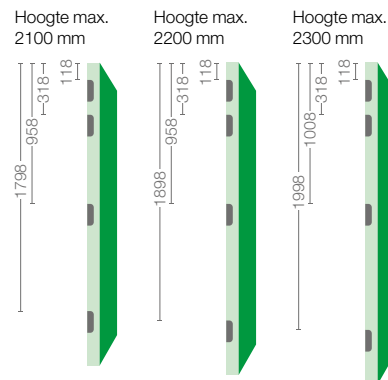

Voor hogere deuren zie pag 8

Belastingtabel

Type	Kg.	Aantal	Schroeflengte
1687-15	70	3	4,5 x 40 mm
	80	4	4,5 x 40 mm

Draairaam

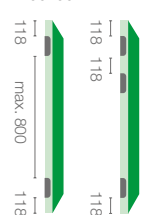

Klepraam

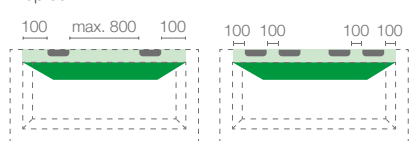

Toepasbare draairichting



Artikelnummer	Materiaal/kleur/finish	Klein-verpakking	Groot-verpakking	Minimaal bestelaantal	Aanbevolen bevestiging
1687-15-23/VE	staal Topcoat gegalvaniseerd	4	16	4	4,5 x 40 mm
1687-15-23/7V	staal Topcoat gegalvaniseerd	-	50	50	4,5 x 40 mm

Bijzonderheden:

/VE = EAN sticker direct op product | /7V = los gestort

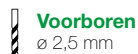

SMART EASYFIX RENOVATIE VEILIGHEIDSSCHARNIER 1688



Toepassing

voor ver openslaande ramen en buitendeuren



TYPE 1688-09

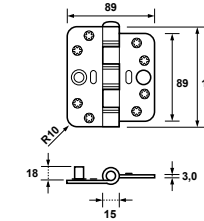

Productpositie

Deur

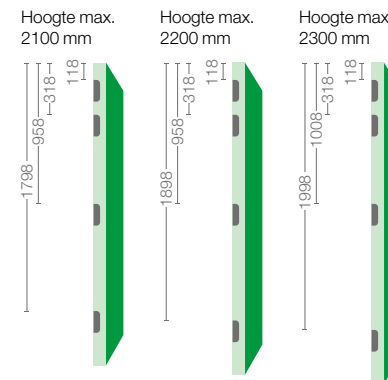

Voor hogere deuren zie pag 8

Belastingtabel

Staal

Type	Kg.	Aantal	Schroeflengte
1688-09	75	2	4,5 x 30 mm
	85	2	4,5 x 40 mm
	100	3	4,5 x 30 mm
	125	3	4,5 x 40 mm
	145	4	4,5 x 40 mm

Draairaam

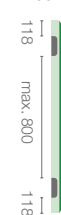

Toepasbare draairichting

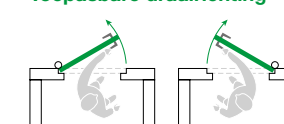

Artikelnummer	Materiaal/kleur/finish	Klein-verpakking	Groot-verpakking	Minimaal bestelaantal	Aanbevolen bevestiging
1688-09-23/VE*	staal Topcoat gegalvaniseerd	6	48	6	4,5 x 30 mm / 4,5 x 40 mm
1688-09-23/7V*	staal Topcoat gegalvaniseerd	-	50	50	4,5 x 30 mm / 4,5 x 40 mm
1688-09-23/71V*	staal Xtremecoat gegalvaniseerd	-	50	50	4,5 x 30 mm / 4,5 x 40 mm

Bijzonderheden:

/VE = EAN sticker direct op product | * = ingebouwde dievenklauw op kozijnbleed ipv deurbleed | /7 = los gestort



1689 SMART EASYFIX XDK VEILIGHEIDSSCHARNIER



Toepassing
voor ramen en buitendeuren



TYPE 1689-09

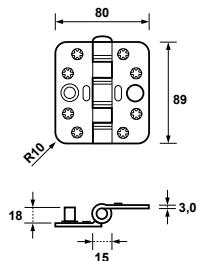

Productpositie

Deur

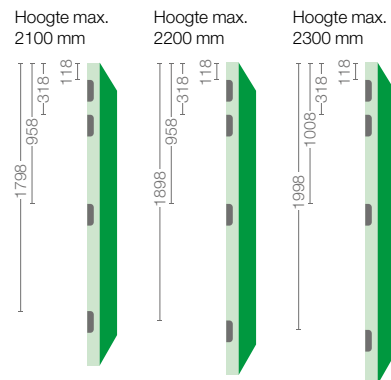

Voor hogere deuren zie pag 8

Belastingtabel

Type	Kg.	Aantal	Schroeflengte
1689-09	65	2	4,5 x 30 mm
	70	2	4,5 x 40 mm
	80	3	4,5 x 30 mm
	85	3	4,5 x 40 mm
	100	4	4,5 x 30 mm
	105	4	4,5 x 40 mm

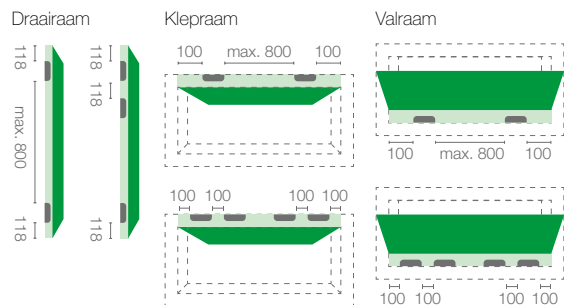

Toepasbare draairichting

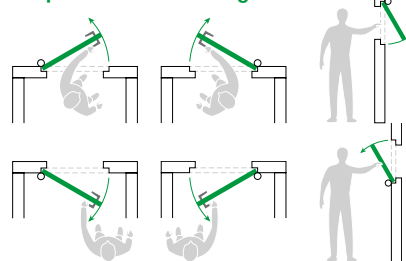

Artikelnummer	Materiaal/kleur/finish	Klein-verpakking	Groot-verpakking	Minimaal bestelaantal	Aanbevolen bevestiging
1689-09-23/VE*	staal Topcoat gegalvaniseerd	6	48	6	4,5 x 30 mm / 4,5 x 40 mm
1689-09-23/7V*	staal Topcoat gegalvaniseerd	-	50	50	4,5 x 30 mm / 4,5 x 40 mm
1689-09-23/71V*	staal Xtremecoat gegalvaniseerd	-	50	50	4,5 x 30 mm / 4,5 x 40 mm

Bijzonderheden:
/7V = los gestort | /VE = EAN sticker direct op product | * = ingebouwde dievenklauw op kozijnbleed ipv deurbleed

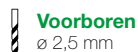

HEAVY DUTY VEILIGHEIDS ONGELAGERD SCHARNIER 1817



Toepassing
voor zware buitendeuren



TYPE 1817-09

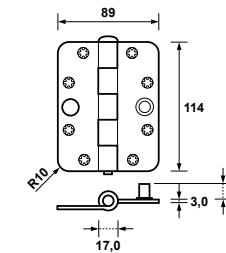

Productpositie

Deur

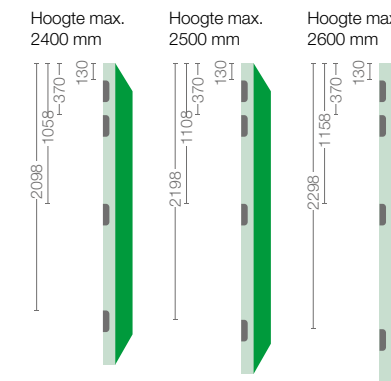
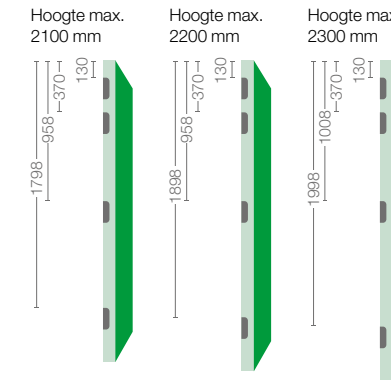

Belastingtabel

Staal

Type	Kg.	Aantal	Schroeflengte
1817-09	90	3	4,5 x 30 mm
	100	3	4,5 x 40 mm
	110	4	4,5 x 30 mm
	120	4	4,5 x 40 mm

Toepasbare draairichting

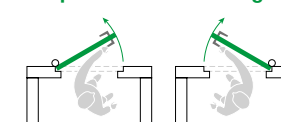

Artikelnummer	Materiaal/kleur/finish	Klein-verpakking	Groot-verpakking	Minimaal bestelaantal	Aanbevolen bevestiging
1817-09-23/7V	staal Topcoat gegalvaniseerd	-	25	25	4,5 x 30 mm / 4,5 x 40 mm

Bijzonderheden:
/7V = los gestort



1837 HEAVY DUTY SCHIJFLAGERSCHARNIER



Toepassing

voor zware deuren



TYPE 1837-09

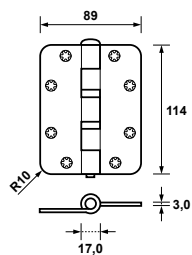

Productpositie

Deur

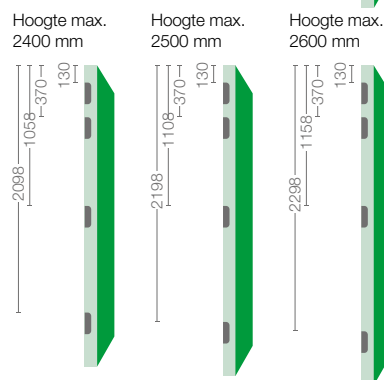
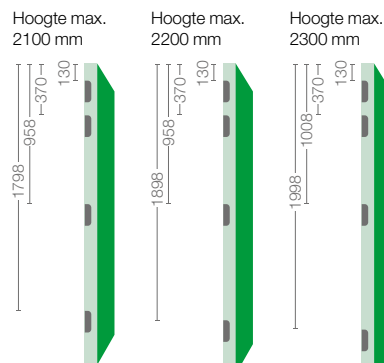

Belastingtabel

Type	Kg.	Aantal	Schroeflengte
1837-09	120	3	4,5 x 30 mm
	140	3	4,5 x 40 mm
	140	4	4,5 x 30 mm
	160	4	4,5 x 40 mm

Toepasbare draairichting

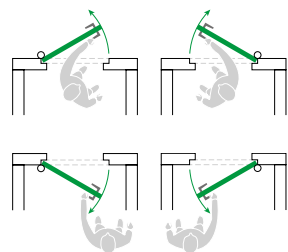

Artikelnummer	Materiaal/kleur/finish	Klein-verpakking	Groot-verpakking	Minimaal bestelaantal	Aanbevolen bevestiging
1837-09-23	staal Topcoat gegalvaniseerd	6	24	6	4,5 x 30 mm / 4,5 x 40 mm
1837-09-81	RVS geborsteld	6	24	6	4,5 x 30 mm / 4,5 x 40 mm

Voorboren
ø 2,5 mm

HEAVY DUTY VEILIGHEIDS SCHIJFLAGERSCHARNIER 1847



Toepassing

voor zware buitendeuren



TYPE 1847-09

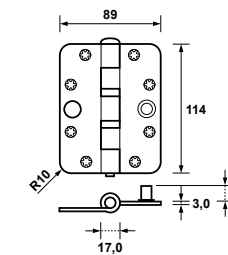

Productpositie

Deur

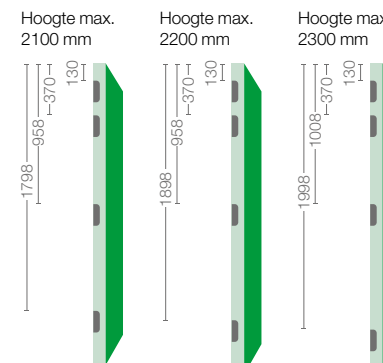

Belastingtabel

Type	Kg.	Aantal	Schroeflengte
1847-09	120	3	4,5 x 30 mm
	140	3	4,5 x 40 mm
	140	4	4,5 x 30 mm
	160	4	4,5 x 40 mm

Toepasbare draairichting

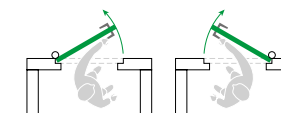

Artikelnummer	Materiaal/kleur/finish	Klein-verpakking	Groot-verpakking	Minimaal bestelaantal	Aanbevolen bevestiging
1847-09-23/VE	staal Topcoat gegalvaniseerd	4	16	4	4,5 x 30 mm / 4,5 x 40 mm
1847-09-23/7V	staal Topcoat gegalvaniseerd	-	50	50	4,5 x 30 mm / 4,5 x 40 mm
1847-09-81/VE	RVS geborsteld	4	16	4	4,5 x 30 mm / 4,5 x 40 mm

Bijzonderheden:
/VE = EAN sticker direct op product | /7 = los gestort

Voorboren
ø 2,5 mm

1847 HEAVY DUTY VEILIGHEIDS SCHIJFLAGERSCHARNIER



Toepassing

voor ver openslaande zware buitendeuren



TYPE 1847-15

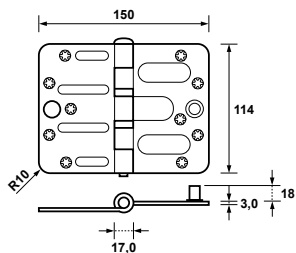

Productpositie

Deur

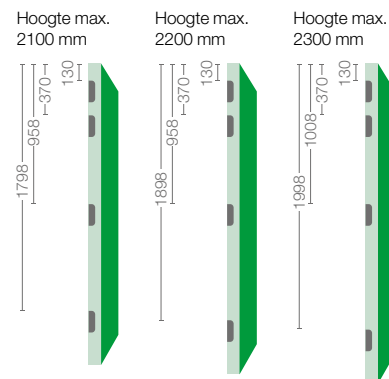

Belastingtabel

Type	Kg.	Aantal	Schroeflengte
1847-15	70	3	4,5 x 30 mm
	100	4	4,5 x 30 mm

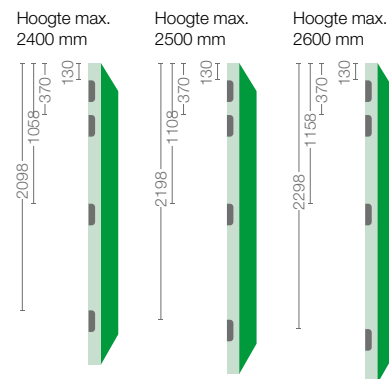

Toepasbare draairichting

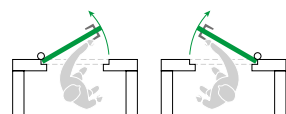

Artikelnummer	Materiaal/kleur/finish	Klein-verpakking	Groot-verpakking	Minimaal bestelaantal	Aanbevolen bevestiging
1847-15-23/V	staal Topcoat gegalvaniseerd	3	12	3	4,5 x 30 mm

Voorboren
ø 2,5 mm

HEAVY DUTY VEILIGHEIDS SCHIJFLAGERSCHARNIER 1847



Toepassing

voor ver openslaande zware buitendeuren



TYPE 1847-17

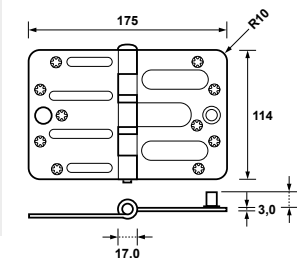

Productpositie

Deur



Belastingtabel

Type	Kg.	Aantal	Schroeflengte
1847-17	60	3	4,5 x 30 mm
	90	4	4,5 x 30 mm



Toepasbare draairichting

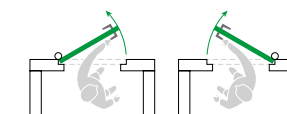

Artikelnummer	Materiaal/kleur/finish	Klein-verpakking	Groot-verpakking	Minimaal bestelaantal	Aanbevolen bevestiging
1847-17-23/V	staal Topcoat gegalvaniseerd	3	12	3	4,5 x 30 mm

Voorboren
ø 2,5 mm

3113 DIEVENKLAUW



Toepassing

voor naar buitendraaiende ramen en deuren



TYPE 3113

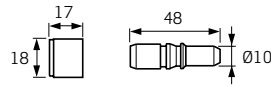

Productpositie

Deur

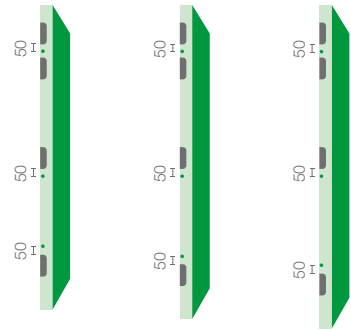

Klepraam

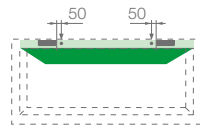

Draairaam



Toepasbare draairichting

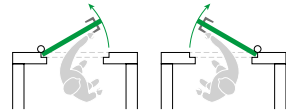

Artikelnummer	Materiaal/kleur/finish	Klein-verpakking	Groot-verpakking	Minimaal bestelaantal	Aanbevolen bevestiging
3113-03-22	staal galvanisch verzinkt	25	200	25	-

Bijzonderheden:
/E = EAN sticker direct op product | * = zonder lus



ONDERDELEN EN ACCESSOIRES SCHARNIEREN

TYPE 1103-84

Scharnierpen

voor 1103, 1105, 1113 en 1114 scharnieren (76 mm)

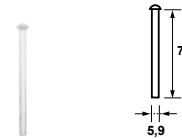

TYPE 1107-16

Scharnierpen

voor 1107, 1117, 1607-09, 1617-09, 1637, 1647, 1657 en 1667 scharnieren

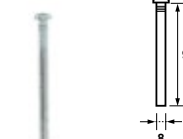

TYPE 1103-85

Scharnierpen

voor 1103, 1105, 1113 en 1114 scharnieren (89 mm)

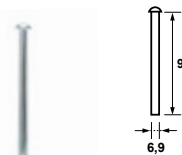

TYPE 1123-85

Scharnierpen

voor 1132, 1531, 1533, 1541 en 1543 scharnieren (89 mm)

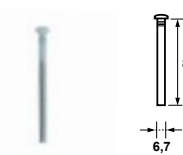

Artikelnummer	Materiaal/kleur/finish	Klein-verpakking	Groot-verpakking	Minimaal bestelaantal	Aanbevolen bevestiging
1103-84-23	staal Topcoat gegalvaniseerd	100	400	100	-
1103-84-23/E	staal Topcoat gegalvaniseerd	1 (4 st.)	25 (4 st.)	1 (4 st.)	-
1103-85-23	staal Topcoat gegalvaniseerd	50	200	50	-
1107-16-23	staal Topcoat gegalvaniseerd	50	400	50	-
1123-85-23	staal Topcoat gegalvaniseerd	50	400	50	-

Bijzonderheden:
/E = EAN sticker direct op product | 4 st. = 4 producten per kleinverpakking

ONDERDELEN EN ACCESSOIRES SCHARNIEREN

TYPE 1531-94

Kogellager

voor 1531, 1533, 1541 en 1543 scharnieren (76 mm)

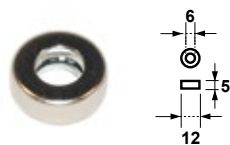

TYPE 1123-95

Nylonlager

voor 1123 en 1132 scharnieren

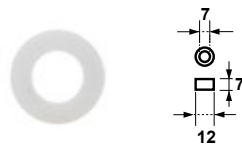

TYPE 1531-96

Kogellager

voor 1531, 1533, 1541 en 1543 scharnieren (89 mm)

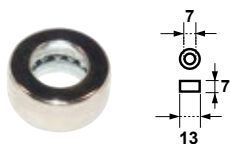

TYPE 1647-01

Schijflager

voor Smart 1637 en 1647 scharnieren

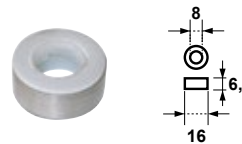

TYPE 1127-37

Kogellager

voor 1657 en 1667 scharnieren



TYPE 1847-01

Schijflager

voor Heavy Duty 1837 en 1847 scharnieren

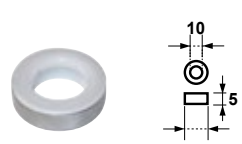

Artikelnummer	Materiaal/kleur/finish	Klein-verpakking	Groot-verpakking	Minimaal bestelaantal	Aanbevolen bevestiging
1531-94-81	RVS	100	2000	100	-
1531-96-81	RVS	100	2000	100	-
1127-37-08	messing vernikkeld	-	100	100	-
1123-95-95	kunststof wit	100	2000	100	-
1647-01-81	RVS / kunststof wit	-	100	100	-
1847-01-81	RVS / kunststof wit	-	100	100	-

ONDERDELEN EN ACCESSOIRES SCHARNIEREN

TYPE 1171-08

Vulring

voor 1177 inboorpaumelles

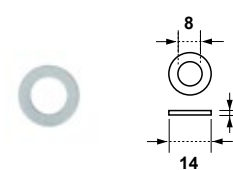

TYPE 1137-94

Venelite lager

voor 1134, 1135, 1136, 1137, 1138 en 1139 scharnieren

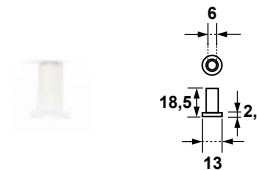

TYPE 1174-91

Vulring

voor 1177 inboorpaumelles

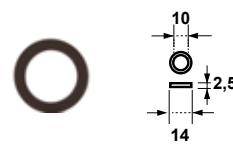

TYPE 1167-64

Indraaihulpstuk

voor inboorpaumelles 1177-10

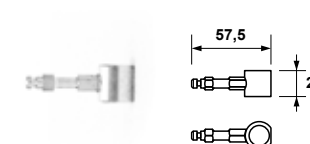

TYPE 1200-95

Vulring

voor 1200, 1201, 1202 en 1203 kogelstiftpaumelles

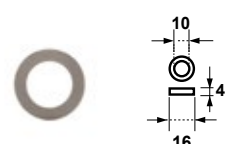

Artikelnummer	Materiaal/kleur/finish	Klein-verpakking	Groot-verpakking	Minimaal bestelaantal	Aanbevolen bevestiging
1171-08-22	galvanisch verzinkt	-	100	100	-
1174-91-95	kunststof zwart	100	5000	100	-
1200-95-81	RVS	-	100	100	-
1137-94-95	kunststof wit	100	2000	100	-
1167-64-24/OT	galvanisch verzinkt	-	100	1	-

ONDERDELEN EN ACCESSOIRES SCHARNIEREN

TYPE 1140-01

Onderlegplaat

voor Heavy Duty scharnieren (114 mm)

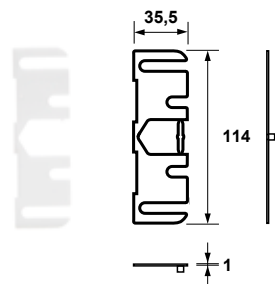

TYPE 1143-01

Onderlegplaat

voor scharnieren (89 mm)

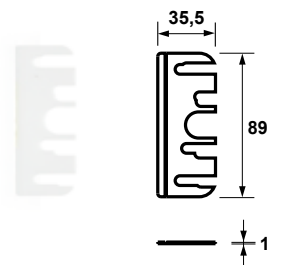

TYPE 1140-02

Onderlegplaat

voor Heavy Duty scharnieren (114 mm)

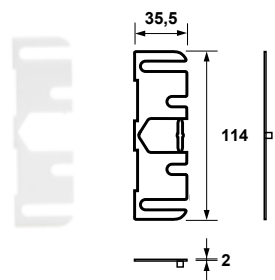

TYPE 1127-24

Scharnierknop

voor kogellagerscharnieren (89 mm)

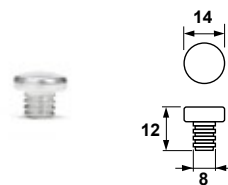

Artikelnummer	Materiaal/kleur/finish	Klein-verpakking	Groot-verpakking	Minimaal bestelaantal	Aanbevolen bevestiging
1140-01-95	kunststof wit	200	800	200	-
1140-02-95	kunststof wit	200	800	200	-
1143-01-95	kunststof wit	200	800	200	-
1127-24-23	staal Topcoat gegalvaniseerd	-	100	100	-

Uitzetters



Inhoudsopgave

Pagina

Veiligheids raamopeners AXA Remote 2.0	94
Combi-raamuitzetters AXAflex Security	102
Combi-raamuitzetters AXAflex	103
Combi-raamuitzetters AXAflex Speciaal	105
Combi-raamuitzetters AXAflex De Luxe	110
Combi-raamuitzetters AXAflex Classic	113
Combi-raamuitzetters AXAfix	115
Raamuitzetters Habilis	118
Raamuitzetters Elite	122
Telescopische uitzetters EX (naar buiten)	125
Telescopische uitzetters IN (naar binnen)	131
Onderdelen en accessoires uitzetters	135

2902 RAAMOPENER AXA REMOTE 2.0



Toepassing

voor bovenlichten, klep- en uitzetramen



TYPE 2902-00

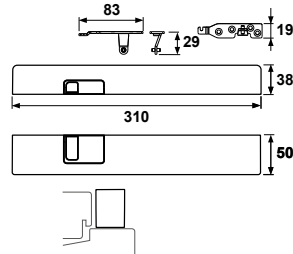

Productpositie

Klep/uitzetraam

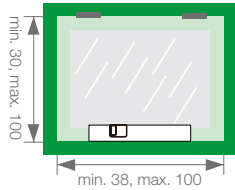

Benodigde montageruimte

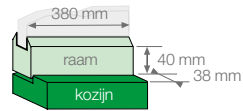

Toepasbare draairichting

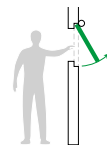

Artikelnummer	Materiaal/kleur/finish	Klein-verpakking	Groot-verpakking	Minimaal bestelaantal	Aanbevolen bevestiging
2902-00-96	zamac / kunststof grijs	1	4	4	4,0 x 40 mm
2902-00-98	zamac / kunststof wit	1	4	4	4,0 x 40 mm

Voorboren
ø 2,0 mm

RAAMOPENER AXA REMOTE 2.0 SOLAR 2902



Toepassing

voor bovenlichten, klep- en uitzetramen



TYPE 2902-90

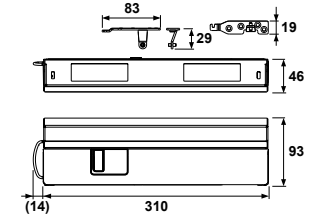

Productpositie

Klep/uitzetraam

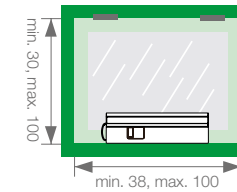

Benodigde montageruimte

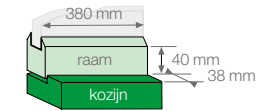

Toepasbare draairichting

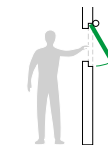

Artikelnummer	Materiaal/kleur/finish	Klein-verpakking	Groot-verpakking	Minimaal bestelaantal	Aanbevolen bevestiging
2902-90-98	zamac / kunststof wit	1	4	4	4,0 x 40 mm

Voorboren
ø 2,0 mm

2902 RAAMOPENER AXA REMOTE 2.0 SYNCHROON



Toepassing

voor bovenlichten, klep- en uitzetramen, uitsluitend voeding dmv adapter (pag.101)



TYPE 2902-50

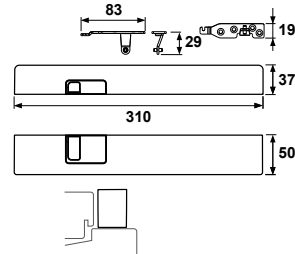

Productpositie

Klep/uitzetraam

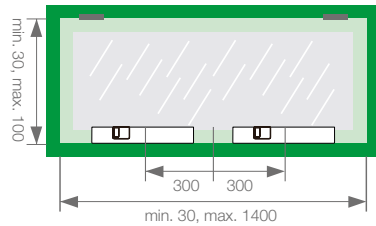

Benodigde montageruimte

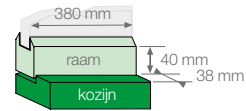

Toepasbare draairichting

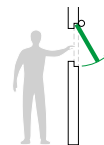

Artikelnummer	Materiaal/kleur/finish	Klein-verpakking	Groot-verpakking	Minimaal bestelaantal	Aanbevolen bevestiging
2902-50-98*	zamac / kunststof wit	1	4	4	4,0 x 40 mm

Bijzonderheden:
* = uitsluitend voeding dmv adapter

Voorboren
ø 2,0 mm

RAAMOPENER AXA REMOTE 2.0 2902



Toepassing

voor valramen



TYPE 2902-20

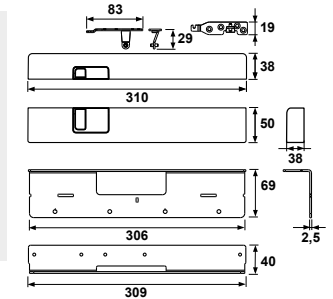

Productpositie

Valraam

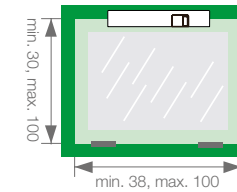

Benodigde montageruimte

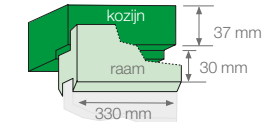
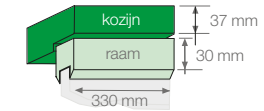

Toepasbare draairichting

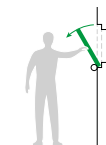

Artikelnummer	Materiaal/kleur/finish	Klein-verpakking	Groot-verpakking	Minimaal bestelaantal	Aanbevolen bevestiging
2902-20-96	zamac / kunststof grijs	1	4	4	4,0 x 40 mm / 4,0 x 70 mm
2902-20-98	zamac / kunststof wit	1	4	4	4,0 x 40 mm / 4,0 x 70 mm
2902-20-99	zamac / kunststof aluline	1	4	4	4,0 x 40 mm / 4,0 x 70 mm

Voorboren
ø 2,0 mm

2902 RAAMOPENER AXA REMOTE 2.0



Toepassing
voor draairamen

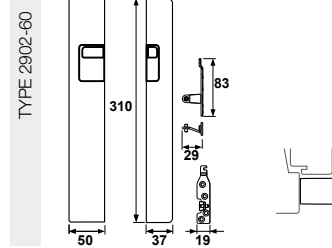

Productpositie

Draairaam

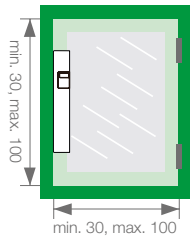

Benodigde montageruimte

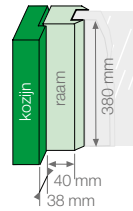

Toepasbare draairichting

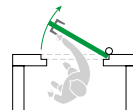

Artikelnummer	Materiaal/kleur/finish	Klein-verpakking	Groot-verpakking	Minimaal bestelaantal	Aanbevolen bevestiging
2902-60-98	zamac / kunststof wit	1	4	4	4,0 x 40 mm

Voorboren
ø 2,0 mm

RAAMOPENER AXA REMOTE 2.0 2902



Toepassing
voor draairamen

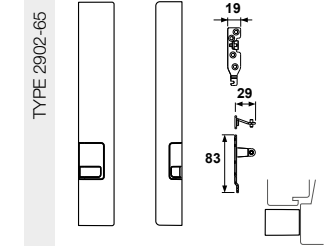

Productpositie

Draairaam

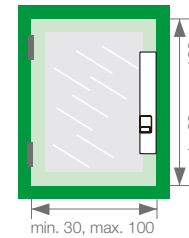

Benodigde montageruimte

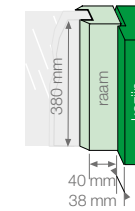

Toepasbare draairichting

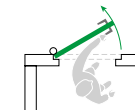

Artikelnummer	Materiaal/kleur/finish	Klein-verpakking	Groot-verpakking	Minimaal bestelaantal	Aanbevolen bevestiging
2902-65-98	zamac / kunststof wit	1	4	4	4,0 x 40 mm

Voorboren
ø 2,0 mm

2902 DAKRAAMSET RAAMOPENER AXA REMOTE 2.0

ACCESSOIRES RAAMOPENER AXA REMOTE 2.0

2902

Toepassing

voor de meeste gangbare merken en typen dakramen (inclusief "oud type" Velux)



TYPE CLASSIC 2902-34

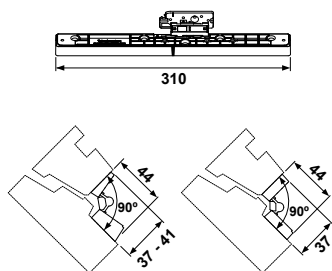

Toepassing

voor de meeste typen nieuwe generatie Velux dakramen (herkenbaar aan de letter **K** in het raam-typennummer)



TYPE VNG 2902-36

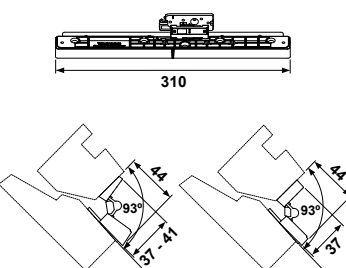

Productpositie

Dakraam

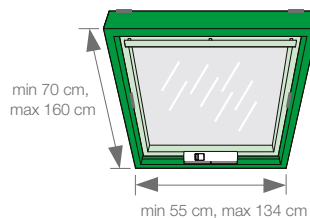

Benodigde montageruimte

Classic

voor de meeste gangbare merken en typen dakramen

VNG

voor de meeste typen nieuwe Velux dakramen

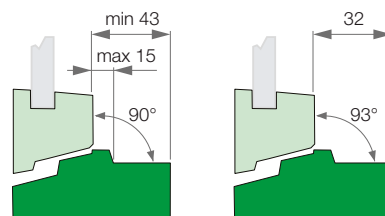

Artikelnummer	Materiaal/kleur/finish	Klein-verpakking	Groot-verpakking	Minimaal bestelaantal	Aanbevolen bevestiging
2902-34-98	Classic, kunststof wit	4	16	4	4,0 x 40 mm 4,2 x 32 mm
2902-36-98	VNG, kunststof wit	4	16	4	4,0 x 40 mm 4,2 x 32 mm

Voorboren
ø 2,0 mm

Adapter

TYPE 2902-31

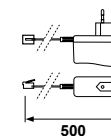

Kap

TYPE 2902-40

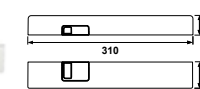

Montageset smal kozijnhout

TYPE 2902-30

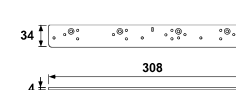

Afstandsbediening

TYPE 2902-32

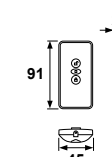

Wandbedieningsknop

TYPE 2902-80

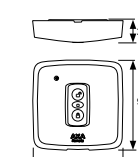

Artikelnummer	Materiaal/kleur/finish	Klein-verpakking	Groot-verpakking	Minimaal bestelaantal	Aanbevolen bevestiging
2902-31-98/E	kunststof wit	1	4	1	
2902-40-96	kunststof grijs	1	4	1	
2902-40-98	kunststof wit	1	4	1	
2902-30-54	staal wit	10	40	1	
2902-32-96	kunststof grijs/antraciet	1	72	1	
2902-32-98	kunststof wit/antraciet	1	72	1	
2902-80-98	wit	1	2	1	3,0 x 30 mm

Bijzonderheden:
/E = EAN sticker direct op product

Voorboren
ø 1,5 mm

2660 COMBI-RAAMUITZETTER AXAFLEX SECURITY

Toepassing

voor bovenlichten, klep- en uitzetramen



TYPE 2660-20

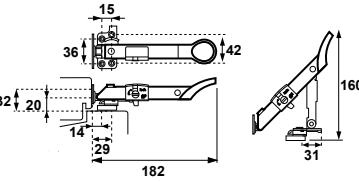

Productpositie

Klep/uitzetraam

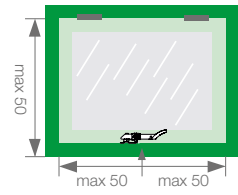

Dubbel geplaatst

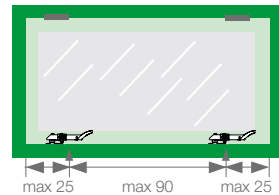

Benodigde montageruimte

zonder onderlegplaat

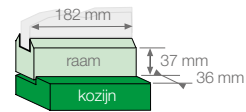

met onderlegplaat (2660-80) voor smal kozijnhout

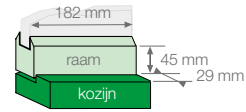

met onderlegplaat (2660-90)

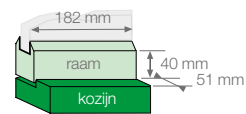

Toepasbare draairichting

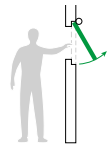

Artikelnummer	Materiaal/kleur/finish	Maximale opening	Klein-verpakking	Groot-verpakking	Minimaal bestelaantal	Aanbevolen bevestiging
2660-20-74/E	RVS wit / kunststof wit	160 mm	-	8	8	4,5 x 40 mm
2660-20-81/E	RVS / kunststof zwart	160 mm	-	8	8	4,5 x 40 mm
2660-20-81/6	RVS / kunststof zwart	160 mm	-	40	40	4,5 x 40 mm

Bijzonderheden:
/6 = seal | /E = EAN sticker direct op product

Voorboren
ø 2,5 mm

COMBI-RAAMUITZETTER AXAFLEX 2640

Toepassing

voor bovenlichten, klep- en uitzetramen



TYPE 2640-10

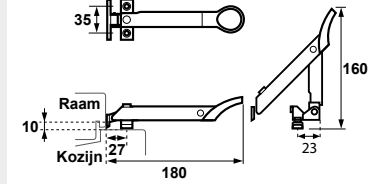

Productpositie

Klep/uitzetraam

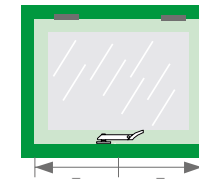

Benodigde montageruimte

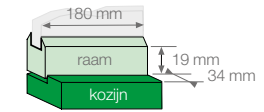

Toepasbare draairichting

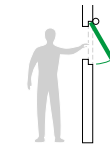

Artikelnummer	Materiaal/kleur/finish	Maximale opening	Klein-verpakking	Groot-verpakking	Minimaal bestelaantal	Aanbevolen bevestiging
2640-10-44/E	staal bruin / kunststof zwart	160 mm	10	80	10	4,0 x 30 mm
2640-10-49/E	staal grijs / kunststof grijs	160 mm	10	80	10	4,0 x 30 mm
2640-10-81/E	RVS / kunststof zwart	160 mm	10	80	10	4,0 x 30 mm
2646-10-74/E	RVS wit / kunststof zwart	160 mm	10	80	10	4,0 x 30 mm
2647-10-74/E	RVS wit / kunststof wit	160 mm	10	80	10	4,0 x 30 mm

Bijzonderheden:
/E = EAN sticker direct op product

Voorboren
ø 2,0 mm

2640 COMBI-RAAMUITZETTER AXAFLEX

COMBI-RAAMUITZETTER AXAFLEX SPECIAAL 2642

Toepassing
voor bovenlichten, klep- en uitzetramen



TYPE 2640-20

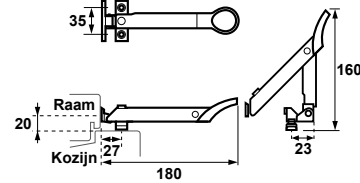

Toepassing
voor metalen of kunststof kozijnen van bovenlichten, klep- en uitzetramen



TYPE 2642-10

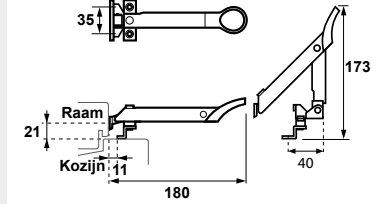

Productpositie

Klep/uitzetraam

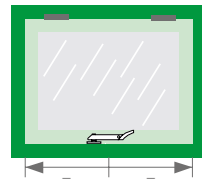

Benodigde montageruimte

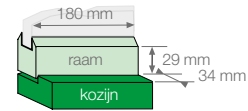

Productpositie

Klep/uitzetraam

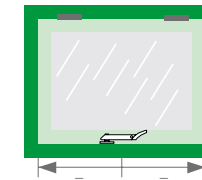

Benodigde montageruimte

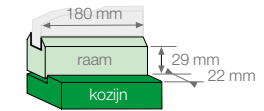

Toepasbare draairichting

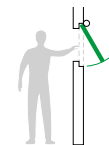

Toepasbare draairichting

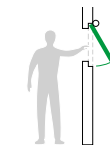

Artikelnummer	Materiaal/kleur/finish	Maximale opening	Klein-verpakking	Groot-verpakking	Minimaal bestelaantal	Aanbevolen bevestiging
2640-20-44/E	staal bruin / kunststof zwart	160 mm	10	80	10	4,0 x 30 mm
2640-20-49/E	staal grijs / kunststof grijs	160 mm	10	80	10	4,0 x 30 mm
2640-20-49/6	staal grijs / kunststof grijs	160 mm	-	50	50	4,0 x 30 mm
2640-20-81/E	RVS / kunststof zwart	160 mm	10	80	10	4,0 x 30 mm
2640-20-81/6	RVS / kunststof zwart	160 mm	-	50	50	4,0 x 30 mm
2647-20-74/E	RVS wit / kunststof wit	160 mm	10	80	10	4,0 x 30 mm

Bijzonderheden:
/6 = seal | /E = EAN sticker direct op product

Voorboren
ø 2,0 mm

Artikelnummer	Materiaal/kleur/finish	Klein-verpakking	Groot-verpakking	Minimaal bestelaantal	Aanbevolen bevestiging
2642-10-81/E	RVS / kunststof zwart	10	80	10	4,0 x 30 mm
2642-10-81/6	RVS / kunststof zwart	-	50	50	4,0 x 30 mm

Bijzonderheden:
/6 = seal | /E = EAN sticker direct op product

Voorboren
ø 2,0 mm

2642 COMBI-RAAMUITZETTER AXAFLEX SPECIAAL

COMBI-RAAMUITZETTER AXAFLEX SPECIAAL 2642

Toepassing

voor metalen of kunststof bovenlichten, klep- en uitzetramen



TYPE 2642-20

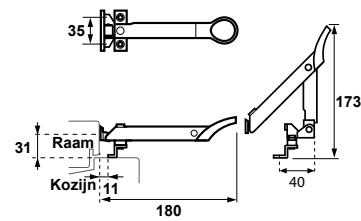

Toepassing

voor metalen of kunststof bovenlichten, klep- en uitzetramen



TYPE 2642-30

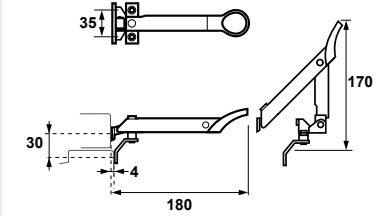

Productpositie

Klep/uitzetraam

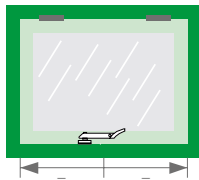

Benodigde montageruimte

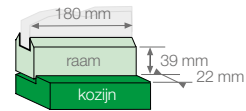

Productpositie

Klep/uitzetraam

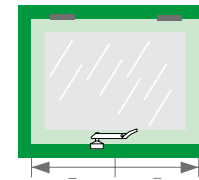

Toepasbare draairichting

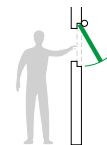

Toepasbare draairichting

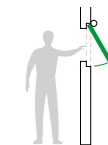

Artikelnummer	Materiaal/kleur/finish	Maximale opening	Klein-verpakking	Groot-verpakking	Minimaal bestelaantal	Aanbevolen bevestiging
2642-20-81	RVS / kunststof zwart	160 mm	10	80	10	4,0 x 30 mm

Voorboren
ø 2,0 mm

Artikelnummer	Materiaal/kleur/finish	Maximale opening	Klein-verpakking	Groot-verpakking	Minimaal bestelaantal	Aanbevolen bevestiging
2642-30-81/E	RVS / kunststof zwart	160 mm	-	8	8	4,0 x 30 mm

Bijzonderheden:
/E = EAN sticker direct op product

Voorboren
ø 2,0 mm

2644 COMBI-RAAMUITZETTER AXAFLEX SPECIAAL



Toepassing

voor metalen of kunststof bovenlichten, klep- en uitzetramen

TYPE 2644-20

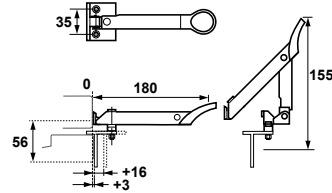

Productpositie

Klep/uitzetraam

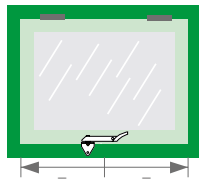

Toepasbare draairichting

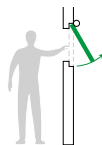

Artikelnummer	Materiaal/kleur/finish	Klein-verpakking	Groot-verpakking	Minimaal bestelaantal	Aanbevolen bevestiging
2644-20-74/E	RVS wit / kunststof wit	-	8	8	4,0 x 30 mm
2644-20-79	RVS wit* / kunststof wit	-	8	8	4,0 x 30 mm
2644-20-81	RVS / kunststof zwart	-	8	8	4,0 x 30 mm

Bijzonderheden:
* = Ral 9001 | /E = EAN sticker direct op product

Voorboren
ø 2,0 mm

COMBI-RAAMUITZETTER AXAFLEX SPECIAAL 2644



Toepassing

voor metalen of kunststof bovenlichten, klep- en uitzetramen

TYPE 2644-30

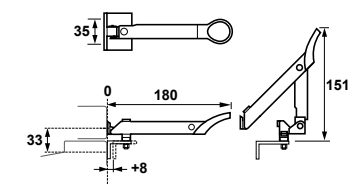

Productpositie

Klep/uitzetraam

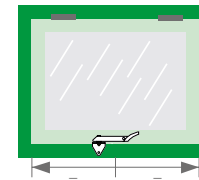

Toepasbare draairichting

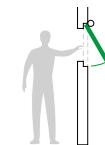

Artikelnummer	Materiaal/kleur/finish	Maximale opening	Klein-verpakking	Groot-verpakking	Minimaal bestelaantal	Aanbevolen bevestiging
2644-30-74	RVS wit / kunststof wit	160 mm	-	8	8	4,0 x 30 mm
2644-30-81	RVS / kunststof zwart	160 mm	-	8	8	4,0 x 30 mm

Voorboren
ø 2,0 mm

2450 COMBI-RAAMUITZETTER AXAFLEX DE LUXE



Toepassing

voor bovenlichten, klep- en uitzetramen

TYPE 2450-20

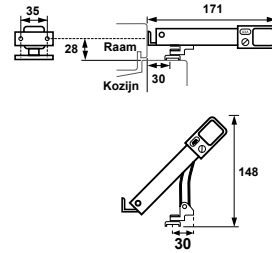

Productpositie

Klep/uitzetraam

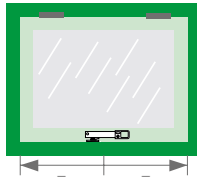

Benodigde montageruimte

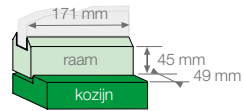

Toepasbare draairichting

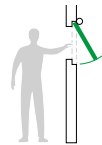

Artikelnummer	Materiaal/kleur/finish	Maximale opening	Klein-verpakking	Groot-verpakking	Minimaal bestelaantal	Aanbevolen bevestiging
2450-20-91	aluminium F1 / kunststof zwart	180 mm	-	8	8	4,0 x 30 mm

Voorboren
ø 2,0 mm

COMBI-RAAMUITZETTER AXAFLEX DE LUXE 2451



Toepassing

voor bovenlichten, klep- en uitzetramen

TYPE 2451-20

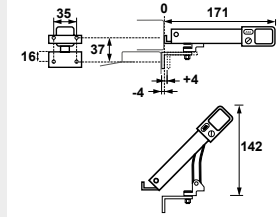

Productpositie

Klep/uitzetraam

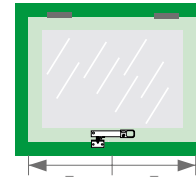

Benodigde montageruimte

Variabel

Toepasbare draairichting

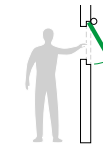

Artikelnummer	Materiaal/kleur/finish	Maximale opening	Klein-verpakking	Groot-verpakking	Minimaal bestelaantal	Aanbevolen bevestiging
2451-20-91	aluminium F1 / kunststof zwart	180 mm	-	8	8	4,0 x 30 mm

Voorboren
ø 2,0 mm

2451 COMBI-RAAMUITZETTER AXAFLEX DE LUXE



Toepassing

voor metalen of kunststof bovenlichten, klep- en uitzetramen

TYPE 2451-30

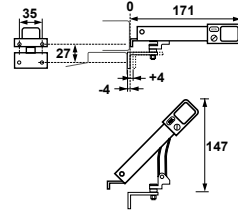

Productpositie

Klep/uitzetraam

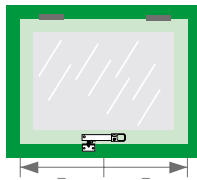

Toepasbare draairichting

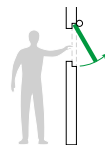

Artikelnummer	Materiaal/kleur/finish	Maximale opening	Klein-verpakking	Groot-verpakking	Minimaal bestelaantal	Aanbevolen bevestiging
2451-30-91	aluminium F1 / kunststof zwart	180 mm	-	8	8	4,0 x 30 mm

Voorboren
ø 2,0 mm

COMBI-RAAMUITZETTER AXAFLEX CLASSIC 2480



Toepassing

voor bovenlichten, klep- en uitzetramen

TYPE 2480-29/39

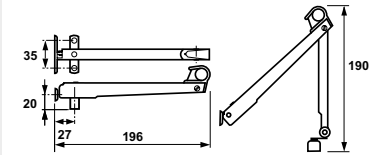

Productpositie

Klep/uitzetraam

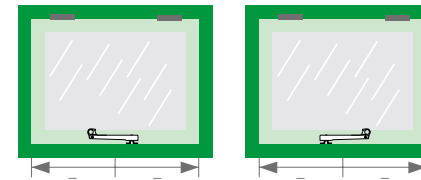

2480-29

2480-39

Benodigde montageruimte

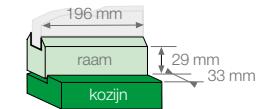

Toepasbare draairichting

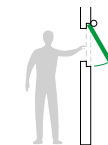

Artikelnummer	Materiaal/kleur/finish	Maximale opening	Klein-verpakking	Groot-verpakking	Minimaal bestelaantal	Aanbevolen bevestiging
2480-29-81/E*	RVS / kunststof zwart	260 mm	-	15	15	4,0 x 30 mm
2480-39-81/E	RVS / kunststof zwart	260 mm	-	15	15	4,0 x 30 mm

Bijzonderheden:
/E = EAN sticker direct op product | * =rechts draaiend

Voorboren
ø 2,0 mm

2480 COMBI-RAAMUITZETTER AXAFLEX CLASSIC

Toepassing

voor bovenlichten, klep- en uitzetramen



TYPE 2480-49

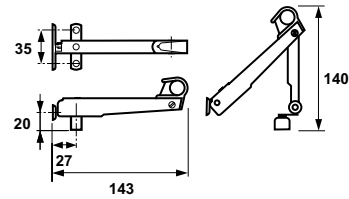

Productpositie

Klep/uitzetraam

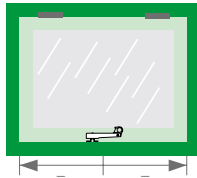

Benodigde montageruimte

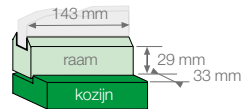

Toepasbare draairichting

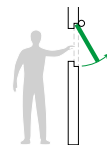

Artikelnummer	Materiaal/kleur/finish	Maximale opening	Klein-verpakking	Groot-verpakking	Minimaal bestelaantal	Aanbevolen bevestiging
2480-49-81	RVS / kunststof zwart	160 mm	-	20	20	4.0 x 30 mm

Voorboren
ø 2.0 mm

COMBI-RAAMUITZETTER AXAFIX 2488

Toepassing

voor bovenlichten, klep- en uitzetramen



TYPE 2488-10

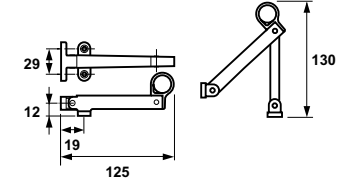

Productpositie

Klep/uitzetraam

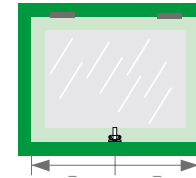

Benodigde montageruimte

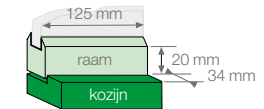

Toepasbare draairichting

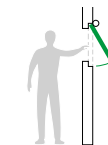

Artikelnummer	Materiaal/kleur/finish	Maximale opening	Klein-verpakking	Groot-verpakking	Minimaal bestelaantal	Aanbevolen bevestiging
2488-10-81/E	RVS / kunststof zwart	160 mm	-	20	20	3,5 x 30 mm

Bijzonderheden:
/E = EAN sticker direct op product

Voorboren
ø 2.0 mm

2488 COMBI-RAAMUITZETTER AXAFIX

Toepassing

voor bovenlichten, klep- en uitzetramen



TYPE 2488-50

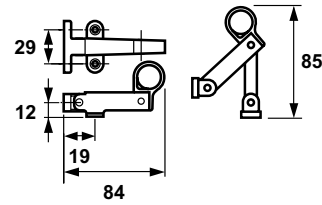

Productpositie

Klep/uitzetraam

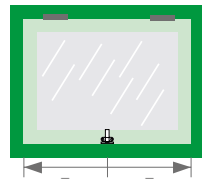

Benodigde montageruimte

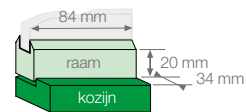

Toepasbare draairichting

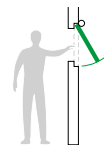

Artikelnummer	Materiaal/kleur/finish	Maximale opening	Klein-verpakking	Groot-verpakking	Minimaal bestelaantal	Aanbevolen bevestiging
2488-50-81/E*	RVS / kunststof zwart	75 mm	-	20	20	3,5 x 30 mm

Bijzonderheden:
/E = EAN sticker direct op product | * = niet wegdraaibaar

Voorboren
ø 2,0 mm

COMBI-RAAMUITZETTER AXAFIX 2489

Toepassing

voor bovenlichten, klep- en uitzetramen



TYPE 2489-50

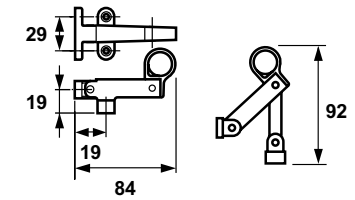

Productpositie

Klep/uitzetraam

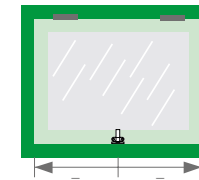

Benodigde montageruimte

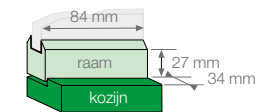

Toepasbare draairichting

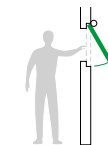

Artikelnummer	Materiaal/kleur/finish	Maximale opening	Klein-verpakking	Groot-verpakking	Minimaal bestelaantal	Aanbevolen bevestiging
2489-50-81/E*	RVS / kunststof zwart	75 mm	-	20	20	3,5 x 30 mm

Bijzonderheden:
/E = EAN sticker direct op product | * = niet wegdraaibaar

Voorboren
ø 2,0 mm

2635 RAAMUITZETTER HABILIS

Toepassing

voor draairamen naar buiten draaiend



TYPE 2635-30

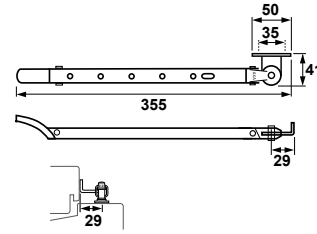

Productpositie

Draairaam

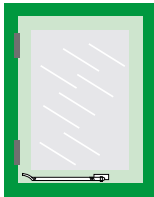

Benodigde montageruimte

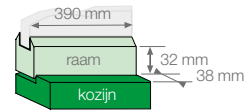

Toepasbare draairichting

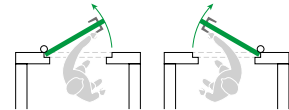

Artikelnummer	Materiaal/kleur/finish	Klein-verpakking	Groot-verpakking	Minimaal bestelaantal	Aanbevolen bevestiging
2635-30-49/E	staal grijs / kunststof grijs	12	72	12	4,0 x 30 mm
2635-30-49/6	staal grijs / kunststof grijs	-	50	50	4,0 x 30 mm
2635-30-81/E	RVS / kunststof zwart	12	72	12	4,0 x 30 mm
2635-30-81/6	RVS / kunststof zwart	-	50	50	4,0 x 30 mm
2636-30-74/E	RVS wit / kunststof zwart	-	50	50	4,0 x 30 mm

Bijzonderheden:
/6 = seal | /E = EAN sticker direct op product

Voorboren
ø 2,0 mm

RAAMUITZETTER HABILIS 2635

Toepassing

voor draairamen naar buiten draaiend



TYPE 2635-31

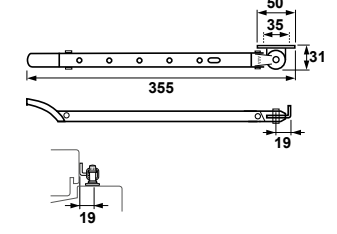

Productpositie

Draairaam



Benodigde montageruimte

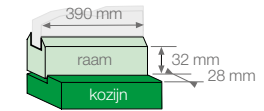

Toepasbare draairichting

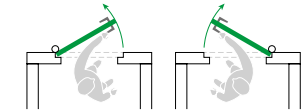

Artikelnummer	Materiaal/kleur/finish	Klein-verpakking	Groot-verpakking	Minimaal bestelaantal	Aanbevolen bevestiging
2635-31-49	staal grijs / kunststof grijs	12	72	12	4,0 x 30 mm
2635-31-81/E	RVS / kunststof zwart	12	72	12	4,0 x 30 mm
2635-31-81/6	RVS / kunststof zwart	-	50	50	4,0 x 30 mm

Bijzonderheden:
/6 = seal | /E = EAN sticker direct op product

Voorboren
ø 2,0 mm

2635 RAAMUITZETTER HABILIS

Toepassing

voor draairamen naar buiten draaiend



TYPE 2635-32

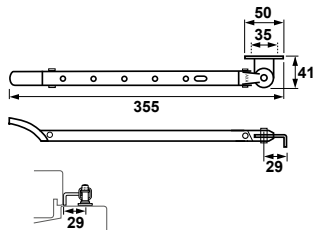

Productpositie

Draairaam

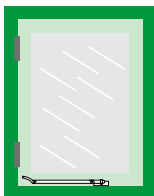

Benodigde montageruimte

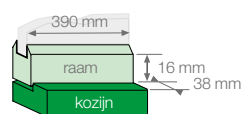

Toepasbare draairichting

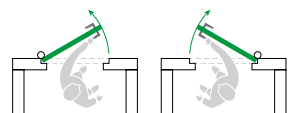

Artikelnummer	Materiaal/kleur/finish	Klein-verpakking	Groot-verpakking	Minimaal bestelaantal	Aanbevolen bevestiging
2635-32-81	RVS / kunststof zwart	12	72	12	4,0 x 30 mm

Voorboren
ø 2,0 mm



UITZETTERPEN RAAMUITZETTER HABILIS 2465

Uitzetterpen

type HL

TYPE 2465-06



Uitzetterpen

type HS

TYPE 2465-17

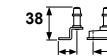
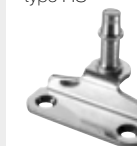

Uitzetterpen

type HV

TYPE 2465-18



Uitzetterpen

type HLH

TYPE 2465-28

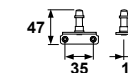

Uitzetterpen

type HTH

TYPE 2468-16

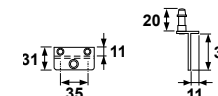

Uitzetterpen

type U

TYPE 2465-16



Artikelnummer	Type	Materiaal/kleur/finish	Klein-verpakking	Groot-verpakking	Minimaal bestelaantal	Aanbevolen bevestiging
2465-06-22	HL	galvanisch verzinkt staal	50	400	50	4,0 x 30 mm
2465-06-22/E	HL	galvanisch verzinkt staal	50	400	50	4,0 x 30 mm
2465-06-81	HL	RVS	50	400	50	4,0 x 30 mm
2465-06-81/E	HL	RVS	50	400	50	4,0 x 30 mm
2465-16-22	U	galvanisch verzinkt staal	50	400	50	4,0 x 30 mm
2465-17-22	HS	galvanisch verzinkt staal	30	240	30	4,0 x 30 mm
2465-17-22/E	HS	galvanisch verzinkt staal	30	240	30	4,0 x 30 mm
2465-18-22	HV	galvanisch verzinkt staal	50	400	50	4,0 x 30 mm
2465-18-22/E	HV	galvanisch verzinkt staal	50	400	50	4,0 x 30 mm
2465-18-81	HV	RVS	50	400	50	4,0 x 30 mm
2465-18-81/E	HV	RVS	50	400	50	4,0 x 30 mm
2465-28-81/E	HLH	RVS	50	400	50	4,0 x 30 mm
2468-16-88	HTH	aluminium wit / galvanisch verzinkt staal	50	400	50	4,0 x 30 mm

Bijzonderheden:
/E = EAN sticker direct op product

Voorboren
ø 2,0 mm

2609 RAAMUITZETTER ELITE

Toepassing

voor draairamen naar buiten draaiend



TYPE 2609-30

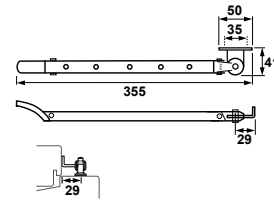

Productpositie

Klep/uitzetraam



Benodigde montageruimte

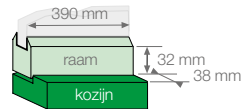

Toepasbare draairichting

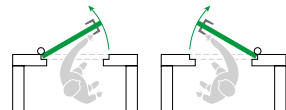

Artikelnummer	Materiaal/kleur/finish	Klein-verpakking	Groot-verpakking	Minimaal bestelaantal	Aanbevolen bevestiging
2609-30-49/E	staal grijs / kunststof grijs	12	72	12	4,0 x 30 mm
2609-30-81/E	RVS / kunststof zwart	12	72	12	4,0 x 30 mm
2609-30-81/6*	RVS / kunststof zwart	-	50	50	4,0 x 30 mm

Bijzonderheden:
*/6 = seal | /E = EAN sticker direct op product

Voorboren
ø 2,0 mm

RAAMUITZETTER ELITE 2609

Toepassing

voor draairamen naar buiten draaiend



TYPE 2609-31

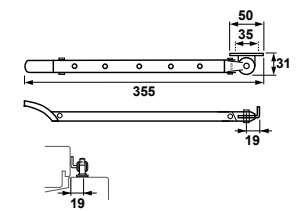

Productpositie

Klep/uitzetraam



Benodigde montageruimte

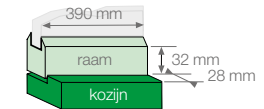

Toepasbare draairichting

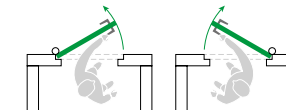

Artikelnummer	Materiaal/kleur/finish	Klein-verpakking	Groot-verpakking	Minimaal bestelaantal	Aanbevolen bevestiging
2609-31-81	RVS / kunststof zwart	12	72	12	4,0 x 30 mm

Voorboren
ø 2,0 mm

2466 UITZETTERPEN RAAMUITZETTER ELITE

TYPE 2466-06

Uitzetterpen type EL



TYPE 2466-17

Uitzetterpen type ESH

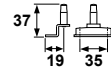

TYPE 2466-18

Uitzetterpen type EV



TYPE 2466-16

Uitzetterpen type U



Artikelnummer	Type	Materiaal/kleur/finish	Klein-verpakking	Groot-verpakking	Minimaal bestelaantal	Aanbevolen bevestiging
2466-06-22	EL	galvanisch verzinkt staal	50	400	50	4,0 x 30 mm
2466-06-22/E	EL	galvanisch verzinkt staal	50	400	50	4,0 x 30 mm
2466-06-81	EL	RVS	50	400	50	4,0 x 30 mm
2466-06-81/E	EL	RVS	50	400	50	4,0 x 30 mm
2466-17-22	ESH	galvanisch verzinkt staal	30	240	30	4,0 x 30 mm
2466-18-22/E	EV	galvanisch verzinkt staal	50	400	50	4,0 x 30 mm
2466-16-22	U	galvanisch verzinkt staal	50	400	50	4,0 x 30 mm

Bijzonderheden:
/E = EAN sticker direct op product

Voorboren
ø 2,0 mm

TELESCOPISCHE UITZETTER 20EX 2815

Toepassing

voor naar buitendraaiende draairamen, bovenlichten, Klep- en uitzetramen



TYPE 2815-00

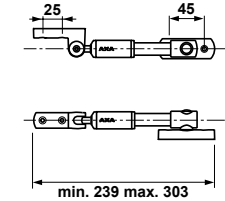

Productpositie

Draairaam

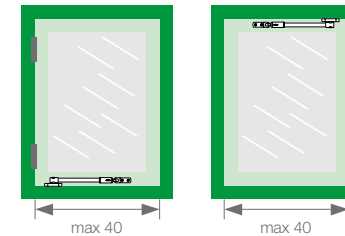

Klep/uitzetraam

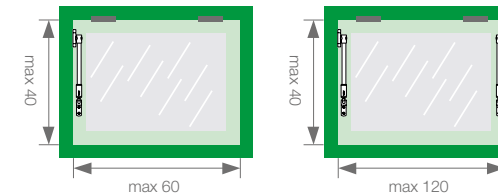

Benodigde montageruimte

Bovenzijde kozijn

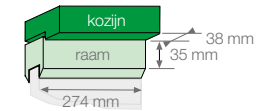

Onderzijde kozijn

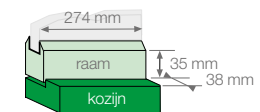

Toepasbare draairichting

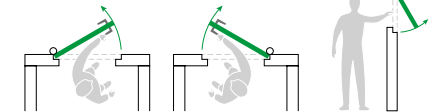

Artikelnummer	Materiaal/kleur/finish	Klein-verpakking	Groot-verpakking	Minimaal bestelaantal	Aanbevolen bevestiging
2815-00-49/E	staal grijs / kunststof grijs	10	60	10	4,0 x 40 mm
2815-00-54/E	staal wit / kunststof wit	10	60	10	4,0 x 40 mm
2815-00-81	RVS / kunststof zwart	10	60	10	4,0 x 40 mm

Bijzonderheden:
/E = EAN sticker direct op product

Voorboren
ø 2,0 mm

2825 TELESCOPISCHE UITZETTER 30EX

Toepassing

voor naar buitendraaiende draairamen, bovenlichten, klep- en uitzetramen



TYPE 2825-00

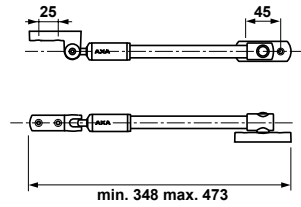

Productpositie

Draairaam

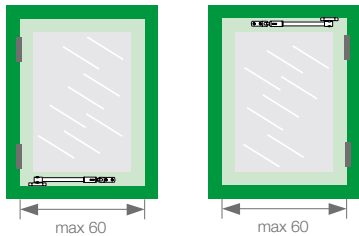

Klep/uitzetraam

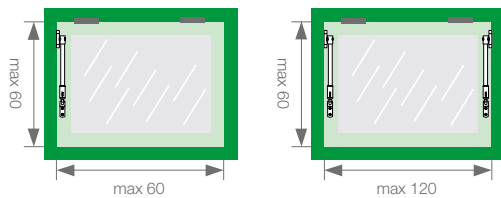

Benodigde montageruimte

Bovenzijde kozijn

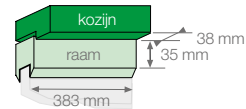

Onderzijde kozijn

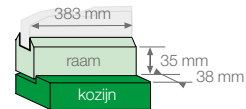

Toepasbare draairichting

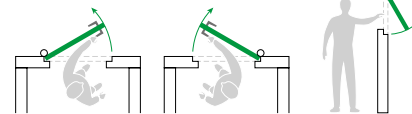

Artikelnummer	Materiaal/kleur/finish	Klein-verpakking	Groot-verpakking	Minimaal bestelaantal	Aanbevolen bevestiging
2825-00-49	staal grijs / kunststof grijs	5	30	5	4,0 x 40 mm
2825-00-49/E	staal grijs / kunststof grijs	5	30	5	4,0 x 40 mm
2825-00-54	staal wit / kunststof wit	5	30	5	4,0 x 40 mm
2825-00-54/E	staal wit / kunststof wit	5	30	5	4,0 x 40 mm
2825-00-81	RVS / kunststof zwart	5	30	5	4,0 x 40 mm
2825-00-81/E	RVS / kunststof zwart	5	30	5	4,0 x 40 mm

Bijzonderheden:
/E = EAN sticker direct op product

Vorboren
ø 2,0 mm

TELESCOPISCHE UITZETTER 30EX 2825

Toepassing

voor metalen of kunststof kozijnen van naar buitendraaiende draairamen



TYPE 2825-03

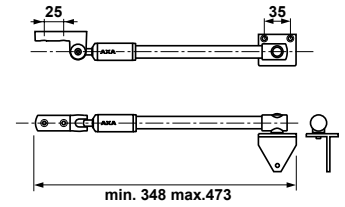

Productpositie

Draairaam

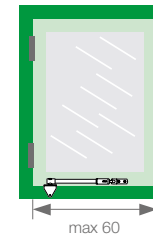

Benodigde montageruimte

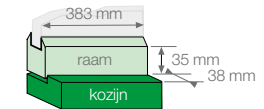

Toepasbare draairichting

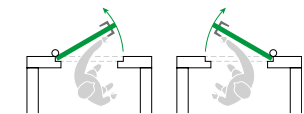

Artikelnummer	Materiaal/kleur/finish	Klein-verpakking	Groot-verpakking	Minimaal bestelaantal	Aanbevolen bevestiging
2825-03-54	staal, aluminium wit / kunststof wit	5	30	5	4,0 x 40 mm

Vorboren
ø 2,0 mm

2835 TELESCOPISCHE UITZETTER 35EX

Toepassing

voor klep-, uitzetramen en naar buitendraaiende draairamen en deuren



TYPE 2835-00

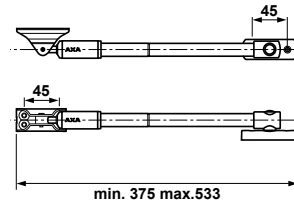

Productpositie

Draairaam

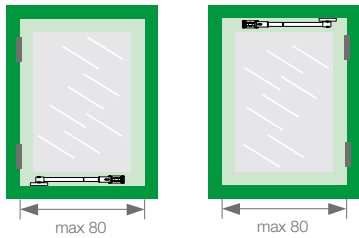

Deur

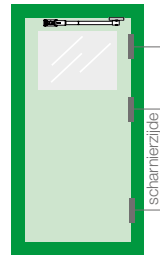

Benodigde montageruimte

Bovenzijde kozijn

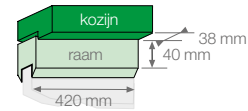

Onderzijde kozijn

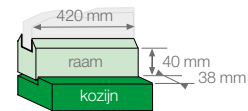

Klep/uitzetraam

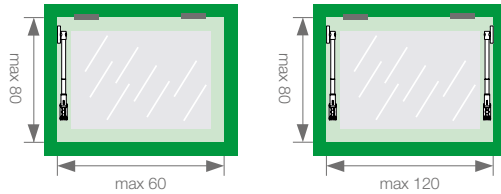

Toepasbare draairichting

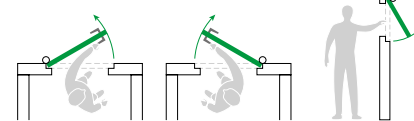

Artikelnummer	Materiaal/kleur/finish	Klein-verpakking	Groot-verpakking	Minimaal bestelaantal	Aanbevolen bevestiging
2835-00-49/E	staal grijs / kunststof grijs	5	30	5	4,0 x 40 mm
2835-00-54/E	staal wit / kunststof wit	5	30	5	4,0 x 40 mm

Bijzonderheden:
/E = EAN sticker direct op product



TELESCOPISCHE UITZETTER 50EX 2845

Toepassing

voor naar buitendraaiende draairamen en deuren



TYPE 2845-00

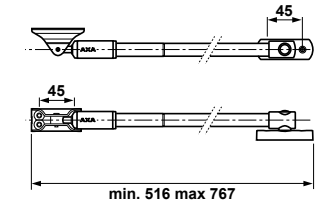

Productpositie

Draairaam

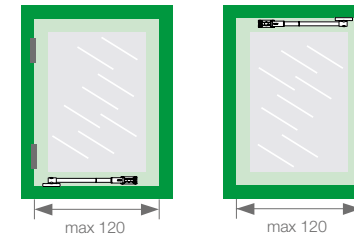

Benodigde montageruimte

Bovenzijde kozijn

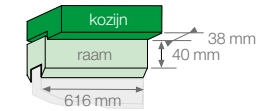

Onderzijde kozijn

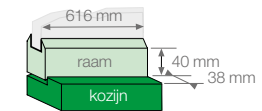

Deur

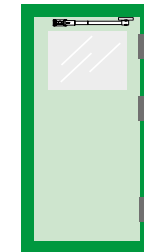

Toepasbare draairichting

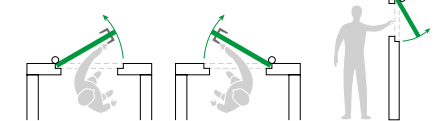

Artikelnummer	Materiaal/kleur/finish	Klein-verpakking	Groot-verpakking	Minimaal bestelaantal	Aanbevolen bevestiging
2845-00-49/E	staal grijs / grijs kunststof	5	30	5	4,0 x 40 mm
2845-00-54/E	staal wit / kunststof wit	5	30	5	4,0 x 40 mm

Bijzonderheden:
/E = EAN sticker direct op product



2865 TELESCOPISCHE UITZETTER 55EX

Toepassing

voor naar buitendraaiende draairamen en deuren



TYPE 2865-00

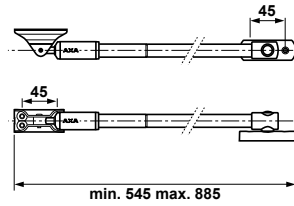

Productpositie

Draairaam

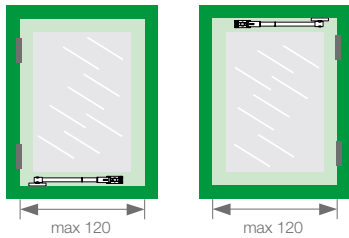

Deur

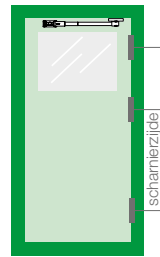

Benodigde montageruimte

Bovenzijde kozijn

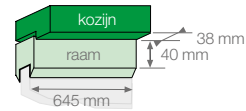

Onderzijde kozijn

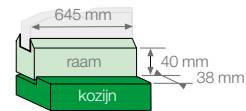

Toepasbare draairichting

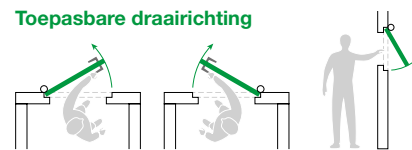

Artikelnummer	Materiaal/kleur/finish	Klein-verpakking	Groot-verpakking	Minimaal bestelaantal	Aanbevolen bevestiging
2865-00-49	staal grijs / kunststof grijs	10	40	10	4,0 x 40 mm
2865-00-54	staal wit / kunststof wit	10	40	10	4,0 x 40 mm

Voorboren
ø 2,0 mm

TELESCOPISCHE UITZETTER 20IN 2816

Toepassing

voor draai-kiepramen en naar binnendraaiende draairamen



TYPE 2816-00

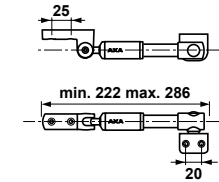

Productpositie

Draai/Draai-kiepraam

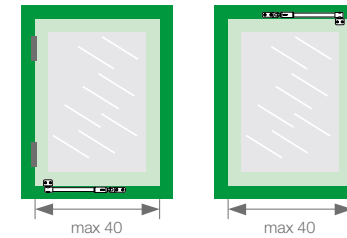

Benodigde montageruimte

Bovenzijde kozijn

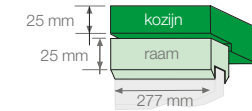

Onderzijde kozijn

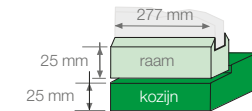

Toepasbare draairichting

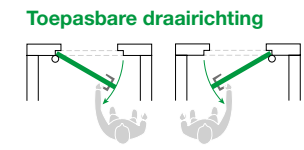

Artikelnummer	Materiaal/kleur/finish	Klein-verpakking	Groot-verpakking	Minimaal bestelaantal	Aanbevolen bevestiging
2816-00-49	staal grijs / kunststof grijs	8	48	8	4,0 x 40 mm
2816-00-54	staal wit / kunststof wit	8	48	8	4,0 x 40 mm
2816-00-81	RVS / kunststof zwart	8	48	8	4,0 x 40 mm

Voorboren
ø 2,0 mm

2826 TELESCOPISCHE UITZETTER 30IN

Toepassing

voor draai-kiepramen en naar binnendraaiende draairamen



TYPE 2826-00

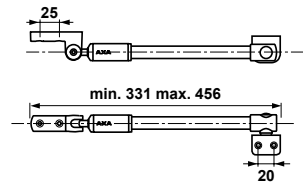

Productpositie

Draai/Draai-kiepraam

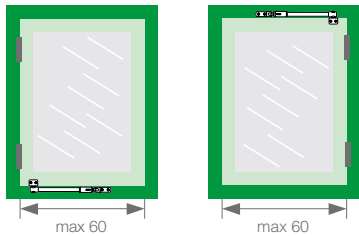

Benodigde montageruimte

Bovenzijde kozijn

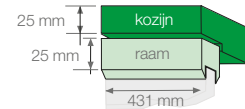

Onderzijde kozijn

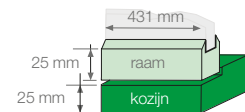

Toepasbare draairichting

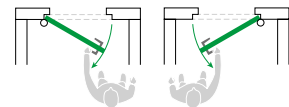

Artikelnummer	Materiaal/kleur/finish	Klein-verpakking	Groot-verpakking	Minimaal bestelaantal	Aanbevolen bevestiging
2826-00-49/E	staal grijs / kunststof grijs	4	24	4	4,0 x 40 mm
2826-00-54/E	staal wit / kunststof wit	4	24	4	4,0 x 40 mm
2826-00-81	RVS / kunststof zwart	4	24	4	4,0 x 40 mm

Bijzonderheden:
/E = EAN sticker direct op product

Voorboren
ø 2,0 mm

TELESCOPISCHE UITZETTER 35IN 2836

Toepassing

voor draai-kiepramen en naar binnendraaiende draairamen en deuren



TYPE 2836-00

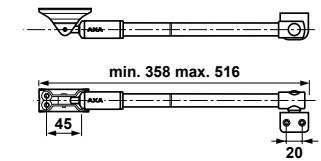

Productpositie

Draai/Draai-kiepraam

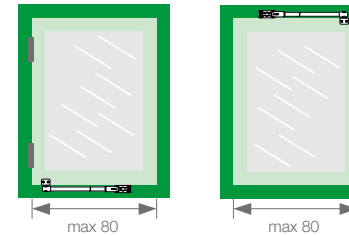

Deur



Benodigde montageruimte

Bovenzijde kozijn

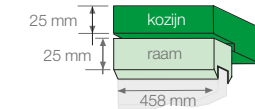

Onderzijde kozijn

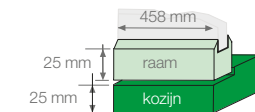

Toepasbare draairichting

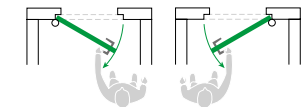

Artikelnummer	Materiaal/kleur/finish	Klein-verpakking	Groot-verpakking	Minimaal bestelaantal	Aanbevolen bevestiging
2836-00-49	staal grijs / kunststof grijs	4	24	4	4,0 x 40 mm

Voorboren
ø 2,0 mm

2846 TELESCOPISCHE UITZETTER 50IN

Toepassing

voor draai-kiepramen en naar binnendraaiende draairamen en deuren



TYPE 2846-00

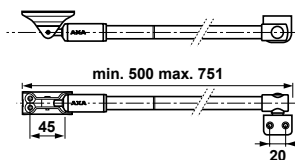

Productpositie

Draairaam

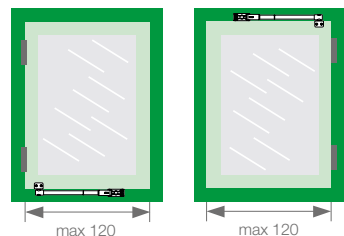

Deur

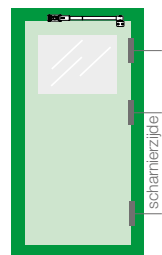

Benodigde montageruimte

Bovenzijde kozijn

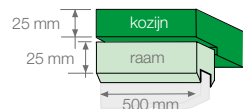

Onderzijde kozijn

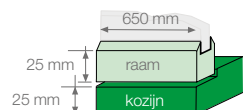

Toepasbare draairichting

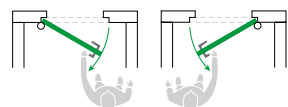

Artikelnummer	Materiaal/kleur/finish	Klein-verpakking	Groot-verpakking	Minimaal bestelaantal	Aanbevolen bevestiging
2846-00-54	staal wit / kunststof wit	4	24	4	4,0 x 40 mm

Voorboren
ø 2,0 mm



ONDERDELEN EN ACCESSOIRES UITZETTERS

Onderlegplaat

voor combi-raamuitzetter AXAfix 2488 (kozijn of raam)

TYPE 2482-91



Onderlegplaat

voor combi-raamuitzetter AXAflex Classic 2480 (kozijn of raam)

TYPE 2490-90



Onderlegplaat

voor combi-raamuitzetter AXAflex 2640 (kozijn of raam)

TYPE 2640-91



Onderlegplaatset (opliggend tochtprofiel)

voor combi-raamuitzetter AXAflex Security 2660 (kozijn of raam)

TYPE 2660-90



Onderlegplaat (smal kozijnhout)

voor combi-raamuitzetter AXAflex Security 2660 (kozijn)

TYPE 2660-80

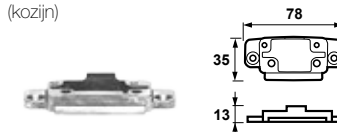

Boormal

voor combi-raamuitzetter AXAflex Security 2660

TYPE 2660-90



Sleutel

voor combi-raamuitzetter AXAflex Security 2660

TYPE 2660-91



Artikelnummer	Materiaal/kleur/finish	Klein-verpakking	Groot-verpakking	Minimaal bestelaantal	Aanbevolen bevestiging
2482-91-96	kunststof zwart	50	1000	50	3,5 x 30 mm
2490-90-95	kunststof wit	50	400	50	4,0 x 40 mm
2640-91-95	kunststof zwart	100	800	100	4,0 x 40 mm
2660-00-01	galvanisch verzinkt staal	1	50	1	-
2660-80-64/E	zamac galvanisch verzinkt	8	32	8	4,5 x 50 mm
2660-90-95	kunststof zwart	10	100	10	4,5 x 45 mm / 4,5 x 55 mm
2660-91-22	galvanisch verzinkt staal	1 (8 st.)	10 (8 st.)	1 (8 st.)	-

Bijzonderheden:
/E = EAN sticker direct op product

Voorboren
ø 2,0 en 2,5 mm

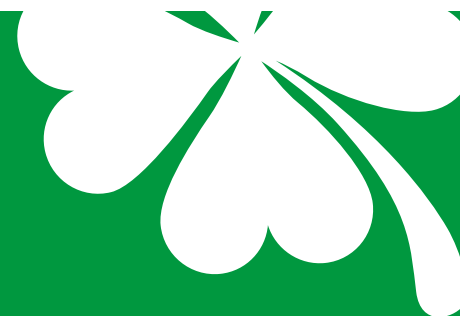

Raamsluitingen

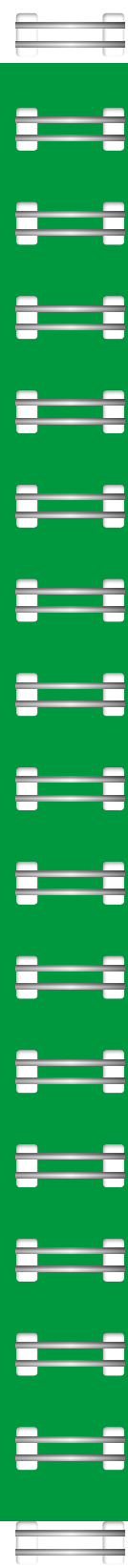

Inhoudsopgave	Pagina
Veiligheids combi-raamsluitingen Oyster	138
Raamsluitingen 3302	140
Raamsluitingen 3308	144
Raamsluitingen 3309	148
Raamsluitingen 3318	150
Veiligheids raamsluitingen 3319	154
Veiligheids raamsluitingen 3320	162
Veiligheids raamsluitingen 3329	170
Veiligheids draai-kiep raamkruk 3350	172
Oplegslot 3011	173
Veiligheids oplegsloten 3012	174
Veiligheids oplegsloten 3015	175
Veiligheids oplegsloten 3016	176
Raamknip	177
Valijzer	177
Ventilatierozet	178
Onderdelen en accessoires raamsluitingen	179

3355 VEILIGHEIDS COMBI-RAAMSLUITING OYSTER



Toepassing

voor naar buiten draaiende draairamen



TYPE 3355-115

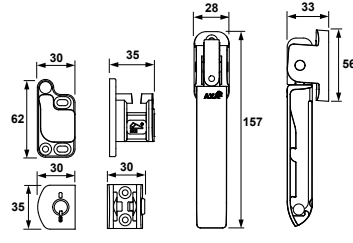

Productpositie

Draairaam

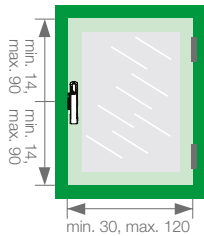

Benodigde montageruimte

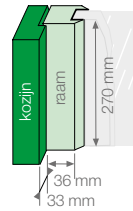

Toepasbare draairichting

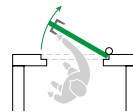

Artikelnummer	Materiaal/kleur/finish	Klein-verpakking	Groot-verpakking	Minimaal bestelaantal	Aanbevolen bevestiging
3355-15-81/L*	RVS geborsteld	1	30	1	4,5 x 40 mm / 4,5 x 50 mm

Bijzonderheden:
* = met geïntegreerde veiligheids kierstandhouder



VEILIGHEIDS COMBI-RAAMSLUITING OYSTER 3355



Toepassing

voor naar buiten draaiende draairamen



TYPE 3355-115

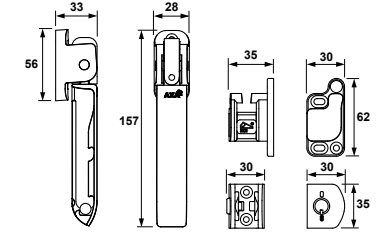

Productpositie

Draairaam

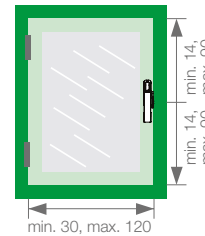

Benodigde montageruimte

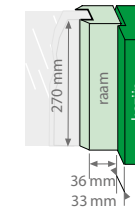

Toepasbare draairichting

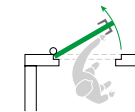

Artikelnummer	Materiaal/kleur/finish	Klein-verpakking	Groot-verpakking	Minimaal bestelaantal	Aanbevolen bevestiging
3355-15-81/R*	RVS geborsteld	1	30	1	4,5 x 40 mm / 4,5 x 50 mm

Bijzonderheden:
* = met geïntegreerde veiligheids kierstandhouder



3302 RAAMSLUITING



Toepassing
voor draairamen en deuren

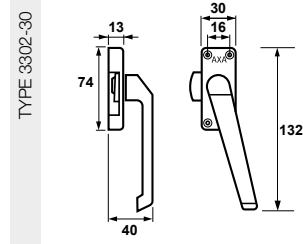

Productpositie

Draairaam

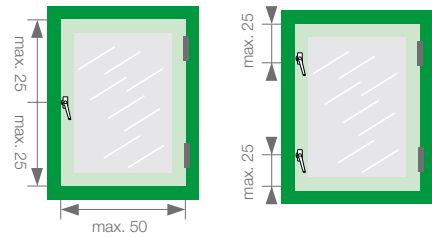

Benodigde montageruimte

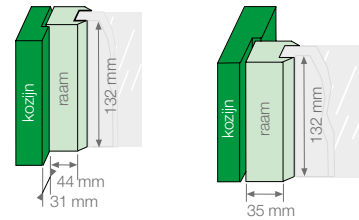

Deur

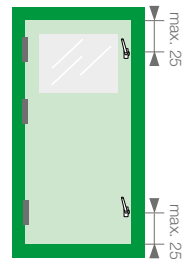

Toepasbare draairichting

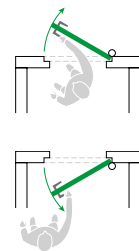

Artikelnummer	Materiaal/kleur/finish	Klein-verpakking	Groot-verpakking	Minimaal bestelaantal	Aanbevolen bevestiging
3302-30-91/E	aluminium geanodiseerd F1	10	60	10	4,0 x 40 mm
3302-30-92/E	aluminium geanodiseerd F2	10	60	10	4,0 x 40 mm

Bijzonderheden:
/E = EAN sticker direct op product

Voorboren
ø 2,0 mm

RAAMSLUITING 3302



Toepassing
voor draairamen en deuren

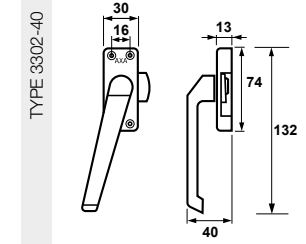

Productpositie

Draairaam

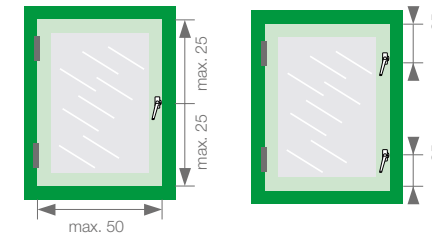

Benodigde montageruimte

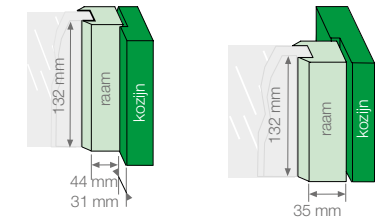

Deur

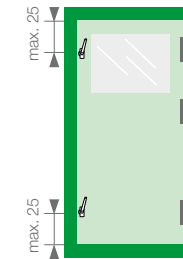

Toepasbare draairichting

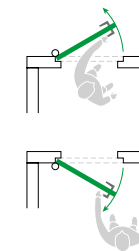

Artikelnummer	Materiaal/kleur/finish	Klein-verpakking	Groot-verpakking	Minimaal bestelaantal	Aanbevolen bevestiging
3302-40-91/E	aluminium geanodiseerd F1	10	60	10	4,0 x 40 mm
3302-40-92/E	aluminium geanodiseerd F2	10	60	10	4,0 x 40 mm

Bijzonderheden:
/E = EAN sticker direct op product

Voorboren
ø 2,0 mm

3302 RAAMSLUITING



Toepassing
voor draairamen en deuren

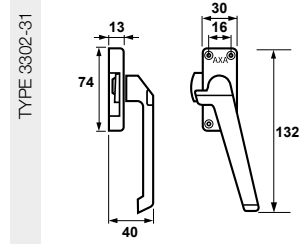

Productpositie

Draairaam

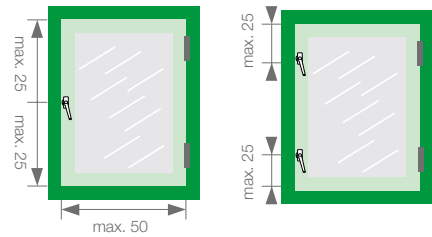

Benodigde montageruimte

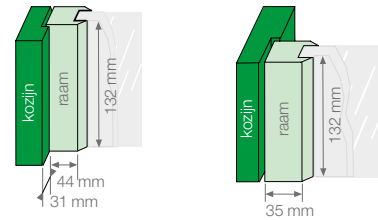

Deur

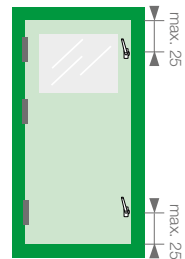

Toepasbare draairichting

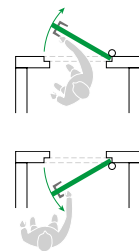

Artikelnummer	Materiaal/kleur/finish	Klein-verpakking	Groot-verpakking	Minimaal bestelaantal	Aanbevolen bevestiging
3302-31-68/E	aluminium wit gelakt	10	60	10	4,0 x 40 mm
3302-31-91/E	aluminium geanodiseerd F1	10	60	10	4,0 x 40 mm
3302-31-92/E	aluminium geanodiseerd F2	10	60	10	4,0 x 40 mm

Bijzonderheden:
/E = EAN sticker direct op product

Voorboren
ø 2,0 mm

RAAMSLUITING 3302



Toepassing
voor draairamen en deuren

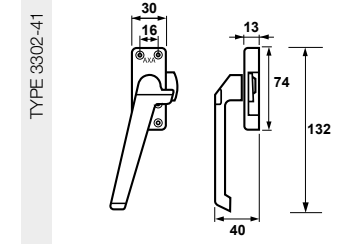

Productpositie

Draairaam

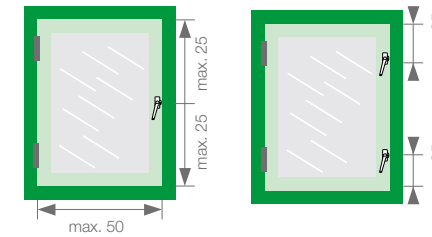

Benodigde montageruimte

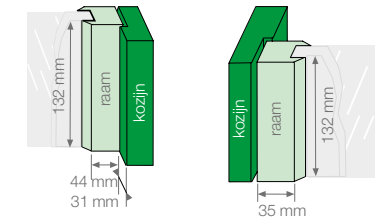

Deur

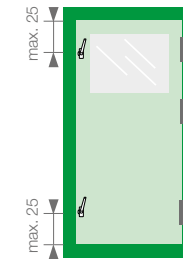

Toepasbare draairichting

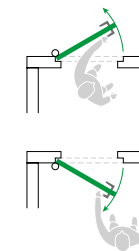

Artikelnummer	Materiaal/kleur/finish	Klein-verpakking	Groot-verpakking	Minimaal bestelaantal	Aanbevolen bevestiging
3302-41-68/E	aluminium wit gelakt	10	60	10	4,0 x 40 mm
3302-41-91/E	aluminium geanodiseerd F1	10	60	10	4,0 x 40 mm
3302-41-92/E	aluminium geanodiseerd F2	10	60	10	4,0 x 40 mm

Bijzonderheden:
/E = EAN sticker direct op product

Voorboren
ø 2,0 mm

3308 RAAMSLUITING



Toepassing
voor draairamen en deuren

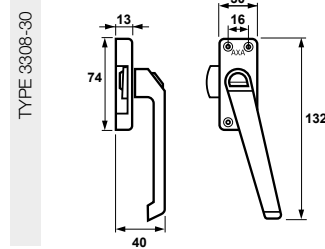

Productpositie

Draairaam

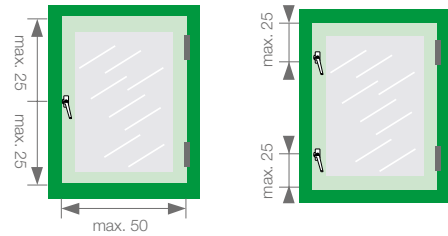

Benodigde montageruimte

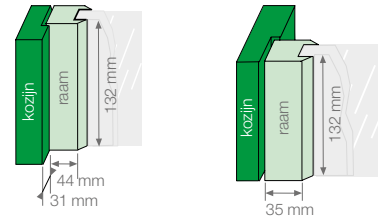

Deur

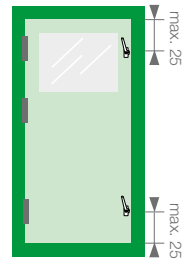

Toepasbare draairichting

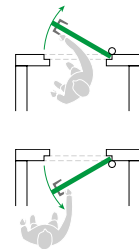

Artikelnummer	Materiaal/kleur/finish	Klein-verpakking	Groot-verpakking	Minimaal bestelaantal	Aanbevolen bevestiging
3308-30-91/E	aluminium geanodiseerd F1	10	60	10	4,0 x 40 mm

Bijzonderheden:
/E = EAN sticker direct op product

Voorboren
ø 2,0 mm

RAAMSLUITING 3308



Toepassing
voor draairamen en deuren

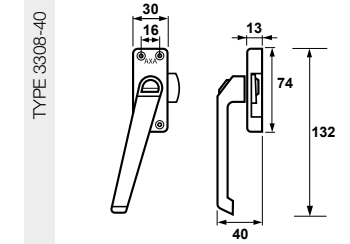

Productpositie

Draairaam

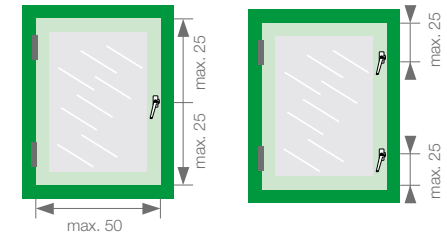

Benodigde montageruimte

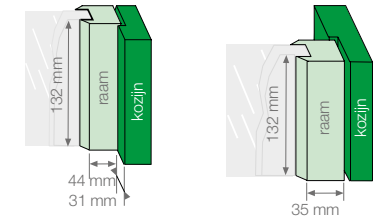

Deur

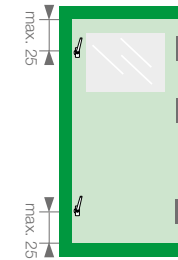

Toepasbare draairichting

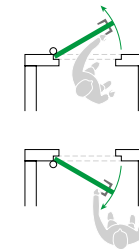

Artikelnummer	Materiaal/kleur/finish	Klein-verpakking	Groot-verpakking	Minimaal bestelaantal	Aanbevolen bevestiging
3308-40-91/E	aluminium geanodiseerd F1	10	60	10	4,0 x 40 mm

Bijzonderheden:
/E = EAN sticker direct op product

Voorboren
ø 2,0 mm

3308 RAAMSLUITING



Toepassing
voor draairamen en deuren

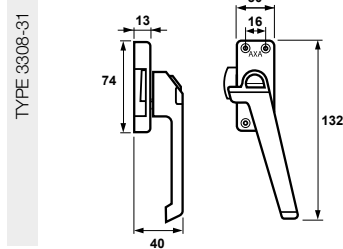

Productpositie

Draairaam

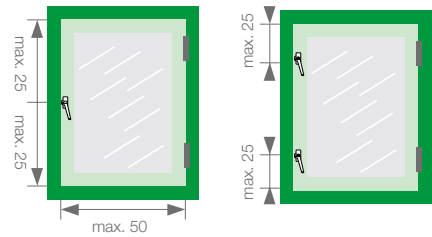

Benodigde montageruimte

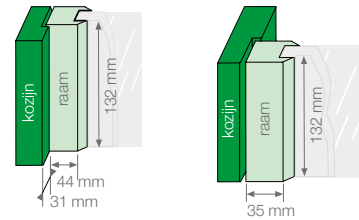

Deur

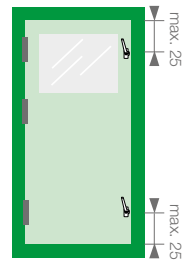

Toepasbare draairichting

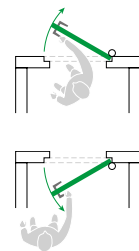

Artikelnummer	Materiaal/kleur/finish	Klein-verpakking	Groot-verpakking	Minimaal bestelaantal	Aanbevolen bevestiging
3308-31-68/E	aluminium wit gelakt	10	60	10	4,0 x 40 mm
3308-31-91/E	aluminium geanodiseerd F1	10	60	10	4,0 x 40 mm
3308-31-92/E	aluminium geanodiseerd F2	10	60	10	4,0 x 40 mm

Bijzonderheden:
/E = EAN sticker direct op product

Voorboren
ø 2,0 mm

RAAMSLUITING 3308



Toepassing
voor draairamen en deuren

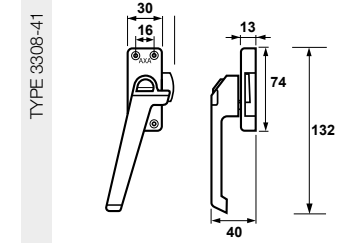

Productpositie

Draairaam

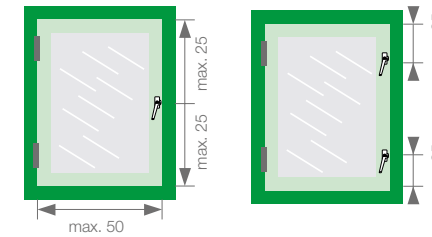

Benodigde montageruimte

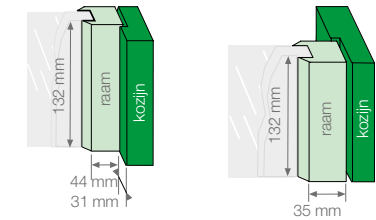

Deur

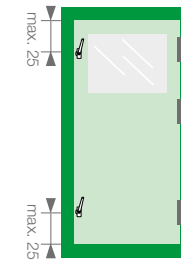

Toepasbare draairichting

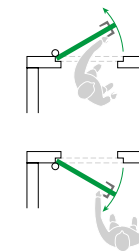

Artikelnummer	Materiaal/kleur/finish	Klein-verpakking	Groot-verpakking	Minimaal bestelaantal	Aanbevolen bevestiging
3308-41-68/E	aluminium wit gelakt	10	60	10	4,0 x 40 mm
3308-41-91/E	aluminium geanodiseerd F1	10	60	10	4,0 x 40 mm
3308-41-92/E	aluminium geanodiseerd F2	10	60	10	4,0 x 40 mm

Bijzonderheden:
/E = EAN sticker direct op product

Voorboren
ø 2,0 mm

3309 RAAMSLUITING



Toepassing
voor draairamen en deuren

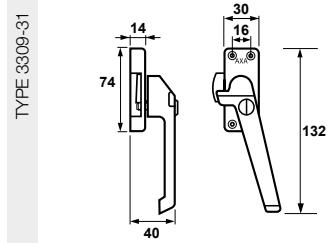

Productpositie

Draairaam

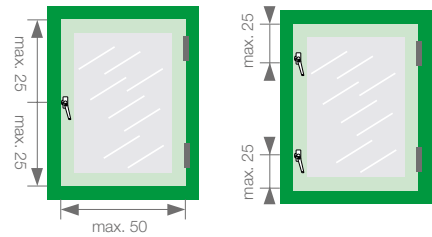

Benodigde montageruimte

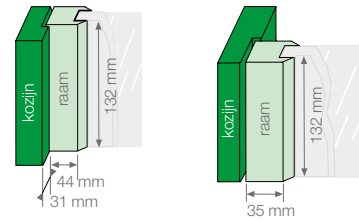

Deur

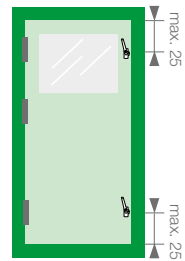

Toepasbare draairichting

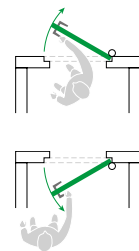

Artikelnummer	Materiaal/kleur/finish	Klein-verpakking	Groot-verpakking	Minimaal bestelaantal	Aanbevolen bevestiging
3309-31-92/GE	aluminium geanodiseerd F2	10	60	10	4,0 x 40 mm

Bijzonderheden:
/GE = gelijksluitend, EAN sticker direct op product

Voorboren
ø 2,0 mm

RAAMSLUITING 3309



Toepassing
voor draairamen en deuren

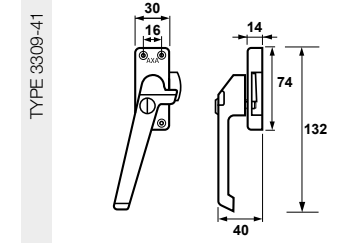

Productpositie

Draairaam

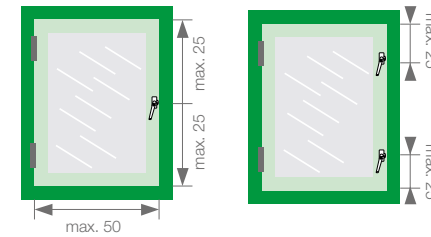

Benodigde montageruimte

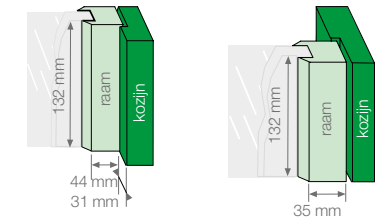

Deur

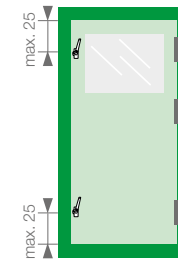

Toepasbare draairichting

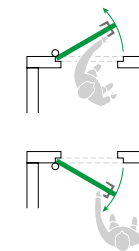

Artikelnummer	Materiaal/kleur/finish	Klein-verpakking	Groot-verpakking	Minimaal bestelaantal	Aanbevolen bevestiging
3309-41-92/GE	aluminium geanodiseerd F2	10	60	10	4,0 x 40 mm

Bijzonderheden:
/GE = gelijksluitend, EAN sticker direct op product

Voorboren
ø 2,0 mm

3318 RAAMSLUITING met inbouwsluitkom



Toepassing
voor draairamen en deuren

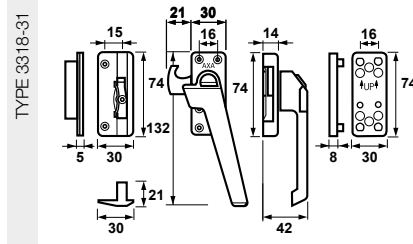

Productpositie

Draairaam

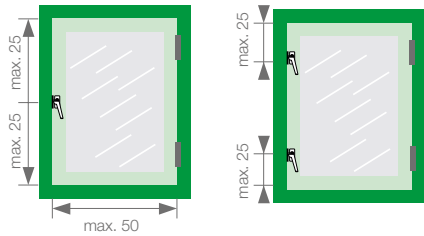

Deur

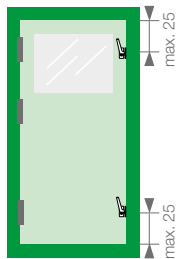

Benodigde montageruimte

met onderlegplaat zonder onderlegplaat

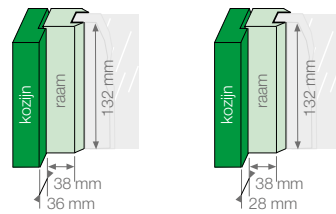

Toepasbare draairichting

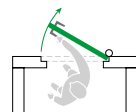

Artikelnummer	Materiaal/kleur/finish	Klein-verpakking	Groot-verpakking	Minimaal bestelaantal	Aanbevolen bevestiging
3318-31-92/E	aluminium geanodiseerd F2	6	36	6	4,0 x 40 mm

Bijzonderheden:
/E = EAN sticker direct op product | bij montage zonder onderlegplaat bevestiging 4,0 x 50 mm

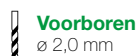

RAAMSLUITING met inbouwsluitkom 3318



Toepassing
voor draairamen en deuren

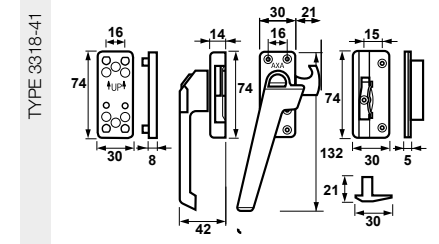

Productpositie

Draairaam

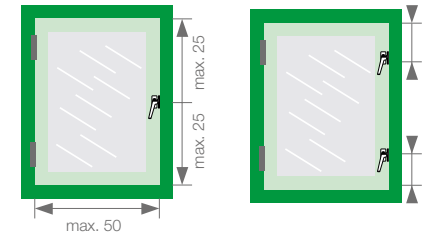

Deur

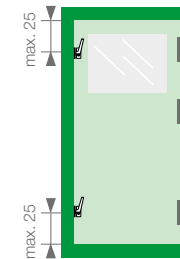

Benodigde montageruimte

met onderlegplaat zonder onderlegplaat

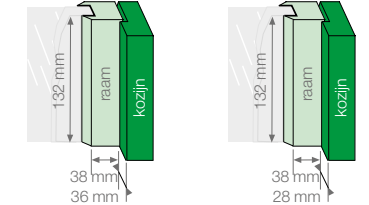

Toepasbare draairichting

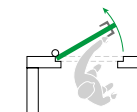

Artikelnummer	Materiaal/kleur/finish	Klein-verpakking	Groot-verpakking	Minimaal bestelaantal	Aanbevolen bevestiging
3318-41-92/E	aluminium geanodiseerd F2	6	36	6	4,0 x 40 mm

Bijzonderheden:
/E = EAN sticker direct op product | bij montage zonder onderlegplaat bevestiging 4,0 x 50 mm



3318 RAAMSLUITING met opbouwsluitkom



Toepassing
voor draairamen en deuren

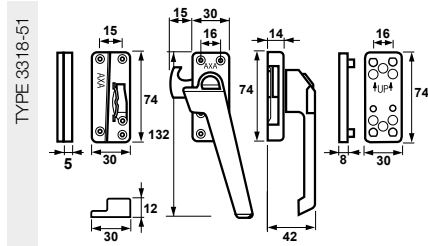

Productpositie

Draairaam

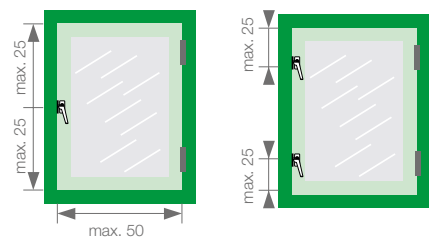

Deur

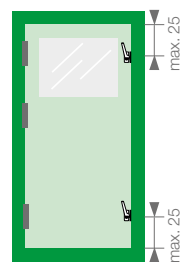

Benodigde montageruimte

met onderlegplaat zonder onderlegplaat

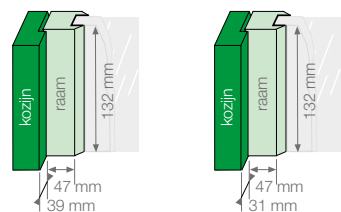

Toepasbare draairichting

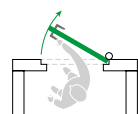

Artikelnummer	Materiaal/kleur/finish	Klein-verpakking	Groot-verpakking	Minimaal bestelaantal	Aanbevolen bevestiging
3318-51-91/6	aluminium geanodiseerd F1	-	50	50	4,0 x 50 mm
3318-51-92/E	aluminium geanodiseerd F2	6	36	6	4,0 x 40 mm

Bijzonderheden:
/6 = seal (zonder onderlegplaat) | /E = EAN sticker direct op product |
bij montage zonder onderlegplaat bevestiging 4,0 x 50 mm



RAAMSLUITING met opbouwsluitkom 3318



Toepassing
voor draairamen en deuren

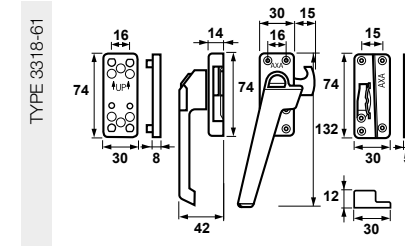

Productpositie

Draairaam

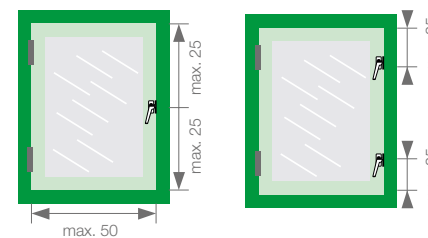

Deur

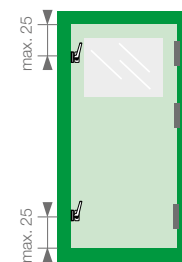

Benodigde montageruimte

met onderlegplaat zonder onderlegplaat

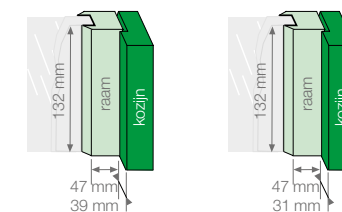

Toepasbare draairichting

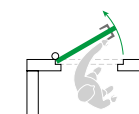

Artikelnummer	Materiaal/kleur/finish	Klein-verpakking	Groot-verpakking	Minimaal bestelaantal	Aanbevolen bevestiging
3318-61-91/6	aluminium geanodiseerd F1	-	50	50	4,0 x 50 mm
3318-61-92/E	aluminium geanodiseerd F2	6	36	6	4,0 x 40 mm

Bijzonderheden:
/6 = seal (zonder onderlegplaat) | /E = EAN sticker direct op product |
bij montage zonder onderlegplaat bevestiging 4,0 x 50 mm



3319 VEILIGHEIDS RAAMSLUITING met inbouwsluitkom



Toepassing
voor draairamen en deuren

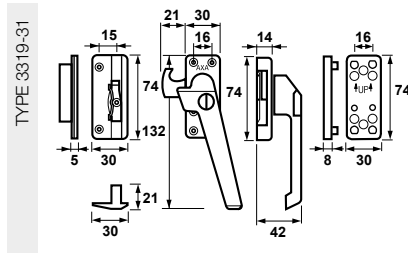

Productpositie

Draairaam

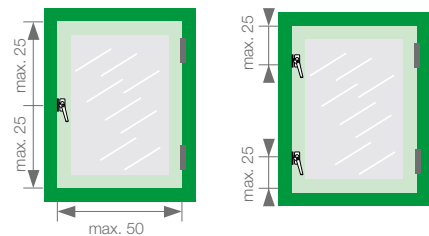

Deur

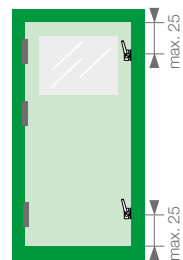

Benodigde montageruimte

met onderlegplaat zonder onderlegplaat

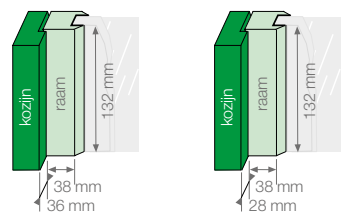

Toepasbare draairichting

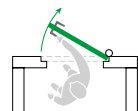

Artikelnummer	Materiaal/kleur/finish	Klein-verpakking	Groot-verpakking	Minimaal bestelaantal	Aanbevolen bevestiging
3319-31-91/6	aluminium geanodiseerd F1	-	50	50	4,0 x 50 mm
3319-31-92/6	aluminium geanodiseerd F2	-	50	50	4,0 x 50 mm
3319-31-92/GE	aluminium geanodiseerd F2	6	36	6	4,0 x 40 mm

Bijzonderheden:
/6 = seal (zonder onderlegplaat) | /E = EAN sticker direct op product |
bij montage zonder onderlegplaat bevestiging 4,0 x 50 mm

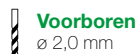

VEILIGHEIDS RAAMSLUITING met inbouwsluitkom 3319



Toepassing
voor draairamen en deuren

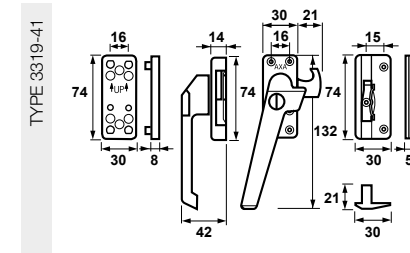

Productpositie

Draairaam

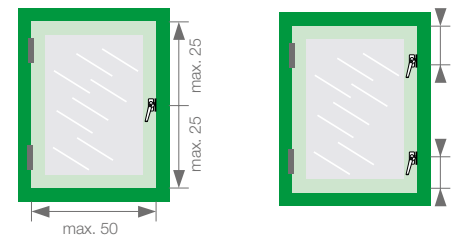

Deur

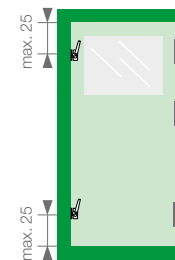

Benodigde montageruimte

met onderlegplaat zonder onderlegplaat

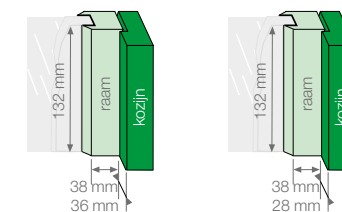

Toepasbare draairichting

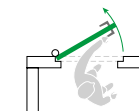

Artikelnummer	Materiaal/kleur/finish	Klein-verpakking	Groot-verpakking	Minimaal bestelaantal	Aanbevolen bevestiging
3319-41-91/6	aluminium geanodiseerd F1	-	50	50	4,0 x 50 mm
3319-41-92/6	aluminium geanodiseerd F2	-	50	50	4,0 x 50 mm
3319-41-92/GE	aluminium geanodiseerd F2	6	36	6	4,0 x 40 mm

Bijzonderheden:
/6 = seal (zonder onderlegplaat) | /E = EAN sticker direct op product |
bij montage zonder onderlegplaat bevestiging 4,0 x 50 mm



3319 VEILIGHEIDS RAAMSLUITING met opbouwsluitkom

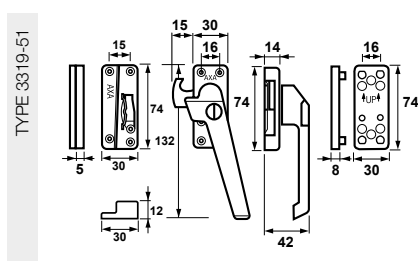

Productpositie

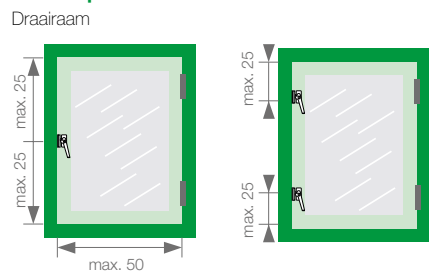

Benodigde montageruimte

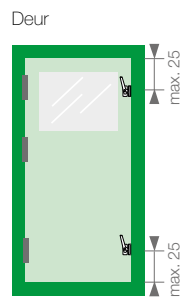
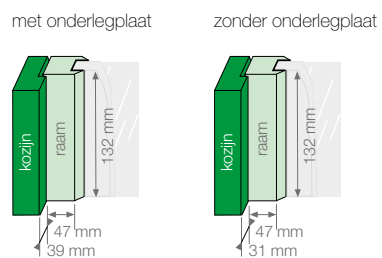

Toepasbare draairichting

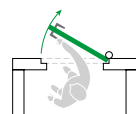

Artikelnummer	Materiaal/kleur/finish	Klein-verpakking	Groot-verpakking	Minimaal bestelaantal	Aanbevolen bevestiging
3319-51-11/GE	aluminium geslepen F1	6	36	6	4,0 x 40 mm
3319-51-91/6	aluminium geanodiseerd F1	-	50	50	4,0 x 50 mm
3319-51-92/6	aluminium geanodiseerd F2	-	50	50	4,0 x 50 mm
3319-51-92/GE	aluminium geanodiseerd F2	6	36	6	4,0 x 40 mm

Bijzonderheden:
/6 = seal (zonder onderlegplaat) | /E = EAN sticker direct op product | bij montage zonder onderlegplaat bevestiging 4,0 x 50 mm



VEILIGHEIDS RAAMSLUITING met opbouwsluitkom 3319

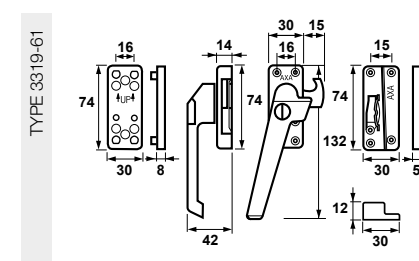

Productpositie

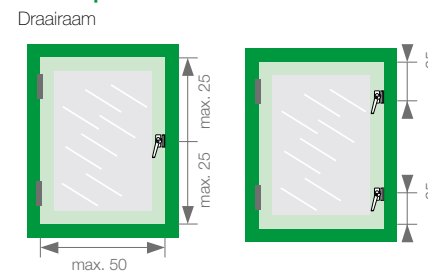

Benodigde montageruimte

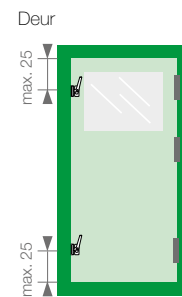
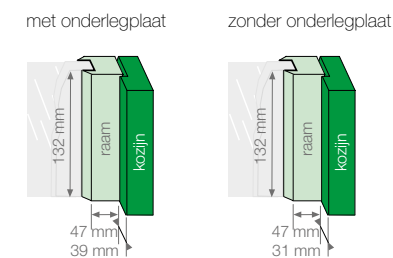

Toepasbare draairichting

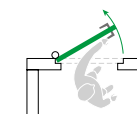

Artikelnummer	Materiaal/kleur/finish	Klein-verpakking	Groot-verpakking	Minimaal bestelaantal	Aanbevolen bevestiging
3319-61-11/GE	aluminium geslepen F1	6	36	6	4,0 x 40 mm
3319-61-91/6	aluminium geanodiseerd F1	-	50	50	4,0 x 50 mm
3319-61-92/6	aluminium geanodiseerd F2	-	50	50	4,0 x 50 mm
3319-61-92/GE	aluminium geanodiseerd F2	6	36	6	4,0 x 40 mm

Bijzonderheden:
/6 = seal (zonder onderlegplaat) | /E = EAN sticker direct op product | bij montage zonder onderlegplaat bevestiging 4,0 x 50 mm



3319 VEILIGHEIDS RAAMSLUITING met smalle opbouwsluitkom



Toepassing
voor draairamen en deuren

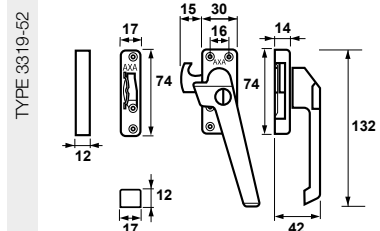

Productpositie

Draairaam

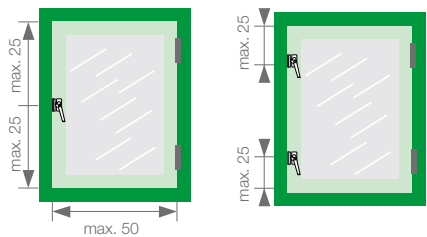

Benodigde montageruimte

zonder onderlegplaat

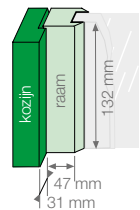

Deur

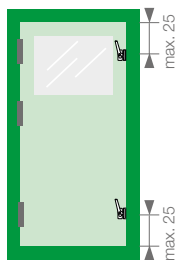

Toepasbare draairichting

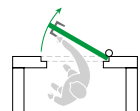

Artikelnummer	Materiaal/kleur/finish	Klein-verpakking	Groot-verpakking	Minimaal bestelaantal	Aanbevolen bevestiging
3319-52-91/6	aluminium geanodiseerd F1	-	50	50	4,0 x 50 mm
3319-52-92/6	aluminium geanodiseerd F2	-	50	50	4,0 x 50 mm

Bijzonderheden:
/6 = seal (zonder onderlegplaat)

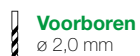

VEILIGHEIDS RAAMSLUITING met smalle opbouwsluitkom 3319



Toepassing
voor draairamen en deuren

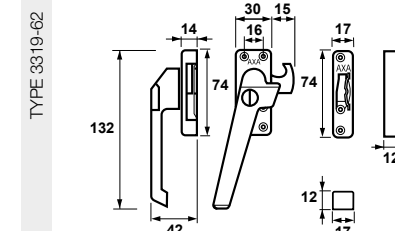

Productpositie

Draairaam

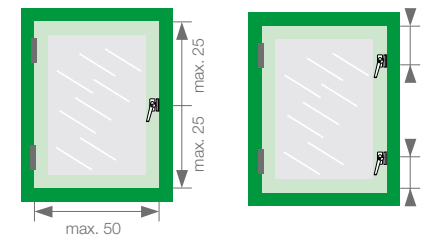

Benodigde montageruimte

zonder onderlegplaat

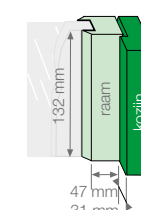

Deur

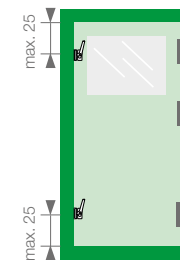

Toepasbare draairichting

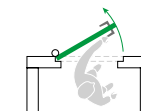

Artikelnummer	Materiaal/kleur/finish	Klein-verpakking	Groot-verpakking	Minimaal bestelaantal	Aanbevolen bevestiging
3319-62-91/6	aluminium geanodiseerd F1	-	50	50	4,0 x 50 mm
3319-62-92/6	aluminium geanodiseerd F2	-	50	50	4,0 x 50 mm

Bijzonderheden:
/6 = seal (zonder onderlegplaat)



3319 VEILIGHEIDS RAAMSLUITING met sluithaak

Toepassing

voor draairamen en deuren

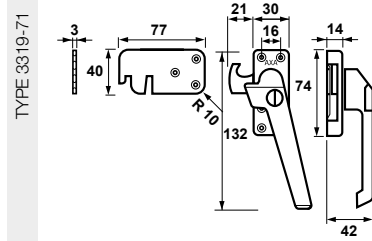

TYPE 3319-71

Productpositie

Draairaam

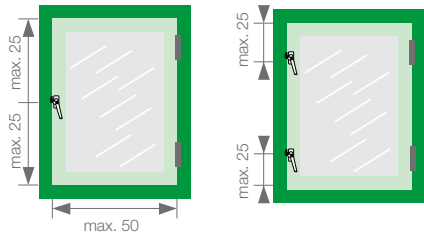

Benodigde montageruimte

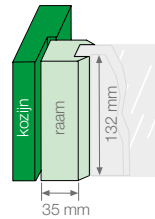

Deur

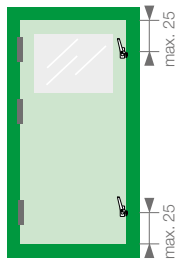

Toepasbare draairichting

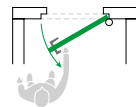

Artikelnummer	Materiaal/kleur/finish	Klein-verpakking	Groot-verpakking	Minimaal bestelaantal	Aanbevolen bevestiging
3319-71-91/GE	aluminium geanodiseerd F1	6	36	6	4,0 x 50 mm
3319-71-92/GE	aluminium geanodiseerd F2	6	36	6	4,0 x 50 mm

Bijzonderheden:
/GE = gelijksluitend, EAN sticker direct op product



VEILIGHEIDS RAAMSLUITING met sluithaak 3319

Toepassing

voor draairamen en deuren

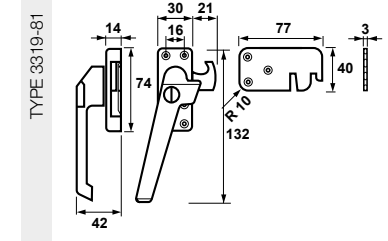

TYPE 3319-81

Productpositie

Draairaam

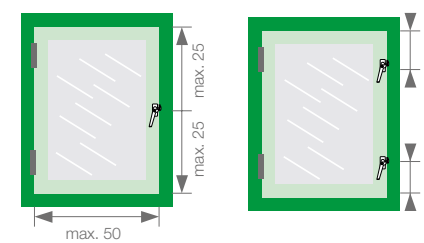

Benodigde montageruimte

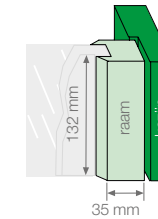

Deur

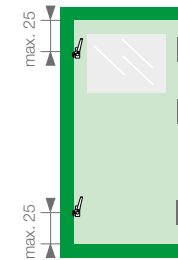

Toepasbare draairichting

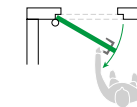

Artikelnummer	Materiaal/kleur/finish	Klein-verpakking	Groot-verpakking	Minimaal bestelaantal	Aanbevolen bevestiging
3319-81-91/GE	aluminium geanodiseerd F1	6	36	6	4,0 x 50 mm
3319-81-92/GE	aluminium geanodiseerd F2	6	36	6	4,0 x 50 mm

Bijzonderheden:
/GE = gelijksluitend, EAN sticker direct op product

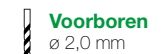

3320 VEILIGHEIDS RAAMSLUITING met inbouwsluitkom



Toepassing
voor draairamen en deuren

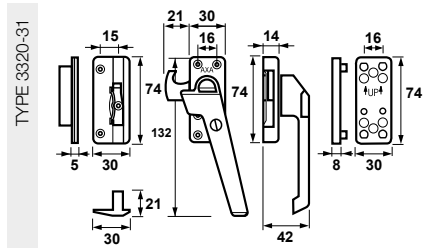

Productpositie

Draairaam

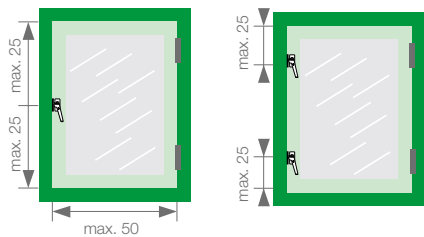

Benodigde montageruimte

met onderlegplaat zonder onderlegplaat

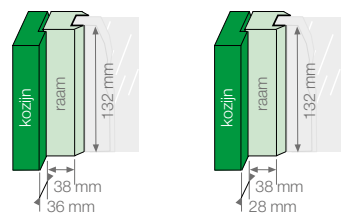

Deur

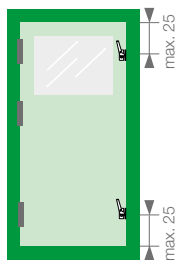

Toepasbare draairichting

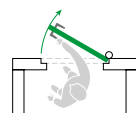

Artikelnummer	Materiaal/kleur/finish	Klein-verpakking	Groot-verpakking	Minimaal bestelaantal	Aanbevolen bevestiging
3320-31-92/E	aluminium geanodiseerd F2	6	36	6	4,0 x 40 mm

Bijzonderheden:
/E = EAN sticker direct op product

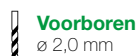

VEILIGHEIDS RAAMSLUITING met inbouwsluitkom 3320



Toepassing
voor draairamen en deuren

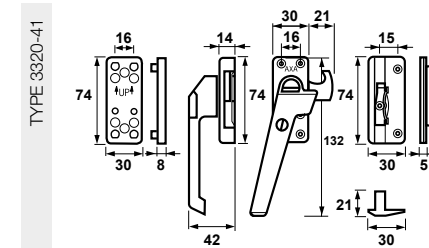

Productpositie

Draairaam

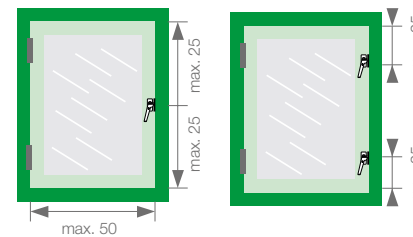

Benodigde montageruimte

met onderlegplaat zonder onderlegplaat

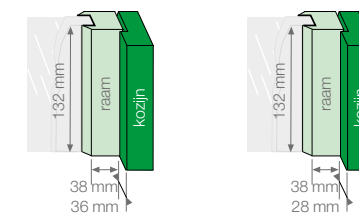

Deur

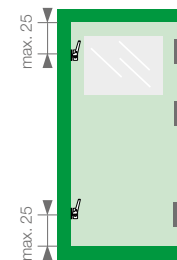

Toepasbare draairichting

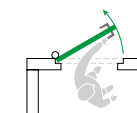

Artikelnummer	Materiaal/kleur/finish	Klein-verpakking	Groot-verpakking	Minimaal bestelaantal	Aanbevolen bevestiging
3320-41-92/E	aluminium geanodiseerd F2	6	36	6	4,0 x 40 mm

Bijzonderheden:
/E = EAN sticker direct op product | bij montage zonder onderlegplaat bevestiging 4,0 x 50 mm



3320 VEILIGHEIDS RAAMSLUITING met opbouwsluitkom



Toepassing
voor draairamen en deuren

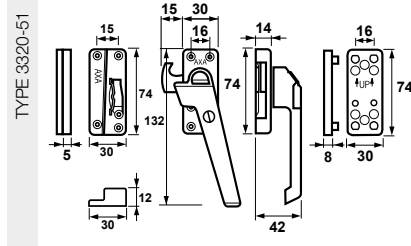

Productpositie

Draairaam

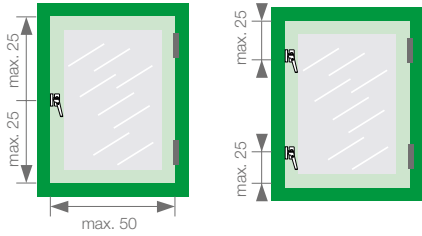

Deur

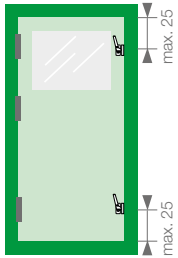

Benodigde montageruimte

met onderlegplaat zonder onderlegplaat

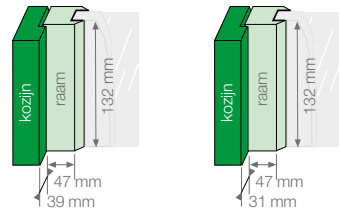

Toepasbare draairichting

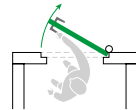

Artikelnummer	Materiaal/kleur/finish	Klein-verpakking	Groot-verpakking	Minimaal bestelaantal	Aanbevolen bevestiging
3320-51-11/E	aluminium geslepen F1	6	36	6	4,0 x 40 mm
3320-51-91/6	aluminium geanodiseerd F1	-	50	50	4,0 x 50 mm
3320-51-92/E	aluminium geanodiseerd F2	6	36	6	4,0 x 40 mm

Bijzonderheden:
/6 = seal (zonder onderlegplaat) | /E = EAN sticker direct op product |
bij montage zonder onderlegplaat bevestiging 4,0 x 50 mm



VEILIGHEIDS RAAMSLUITING met opbouwsluitkom 3320



Toepassing
voor draairamen en deuren

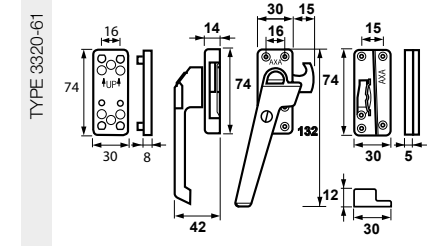

Productpositie

Draairaam

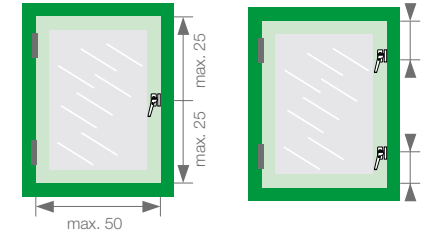

Deur

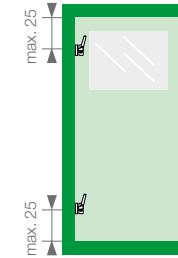

Benodigde montageruimte

met onderlegplaat zonder onderlegplaat

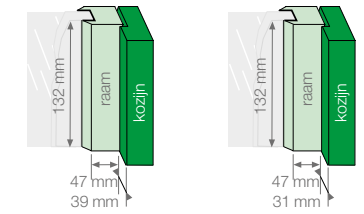

Toepasbare draairichting

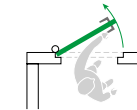

Artikelnummer	Materiaal/kleur/finish	Klein-verpakking	Groot-verpakking	Minimaal bestelaantal	Aanbevolen bevestiging
3320-61-11/E	aluminium geslepen F1	6	36	6	4,0 x 40 mm
3320-61-91/6	aluminium geanodiseerd F1	-	50	50	4,0 x 50 mm
3320-61-92/E	aluminium geanodiseerd F2	6	36	6	4,0 x 40 mm

Bijzonderheden:
/6 = seal (zonder onderlegplaat) | /E = EAN sticker direct op product |
bij montage zonder onderlegplaat bevestiging 4,0 x 50 mm



3320 VEILIGHEIDS RAAMSLUITING met smalle opbouwsluitkom



Toepassing
voor draairamen en deuren



TYPE 3320-52

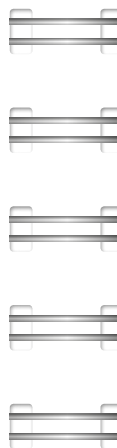
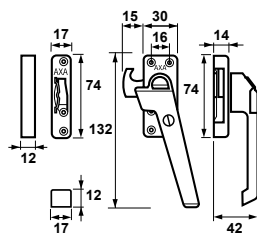

Productpositie

Draairaam

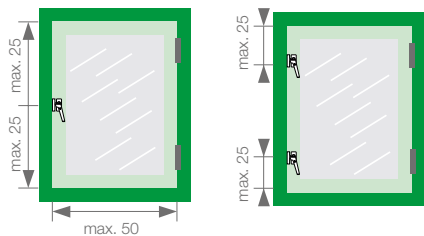

Benodigde montageruimte

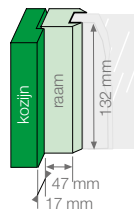

Deur

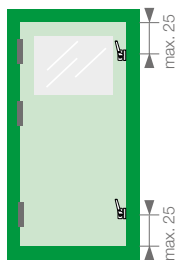

Toepasbare draairichting

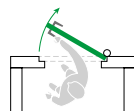

Artikelnummer	Materiaal/kleur/finish	Klein-verpakking	Groot-verpakking	Minimaal bestelaantal	Aanbevolen bevestiging
3320-52-91/6	aluminium geanodiseerd F1	-	50	50	4,0 x 50 mm

Bijzonderheden:
/6 = seal (zonder onderlegplaat)

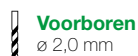

VEILIGHEIDS RAAMSLUITING met smalle opbouwsluitkom 3320



Toepassing
voor draairamen en deuren



TYPE 3320-62

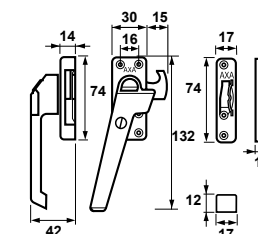

RAAMSLUITINGEN

Productpositie

Draairaam

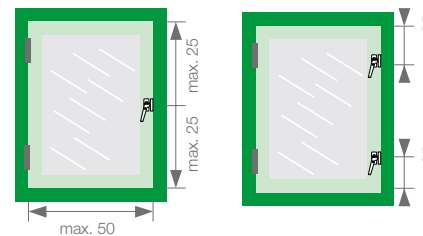

Benodigde montageruimte

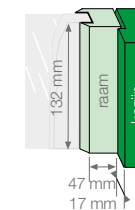

Deur

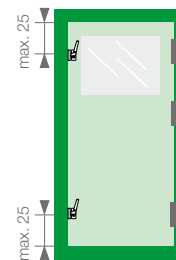

Toepasbare draairichting

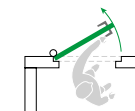

Artikelnummer	Materiaal/kleur/finish	Klein-verpakking	Groot-verpakking	Minimaal bestelaantal	Aanbevolen bevestiging
3320-62-91/6	aluminium geanodiseerd F1	-	50	50	4,0 x 50 mm

Bijzonderheden:
/6 = seal (zonder onderlegplaat)



3320 VEILIGHEIDS RAAMSLUITING met sluitplaat

Toepassing

voor draairamen en deuren

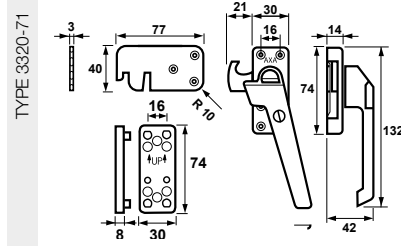

Productpositie

Draairaam

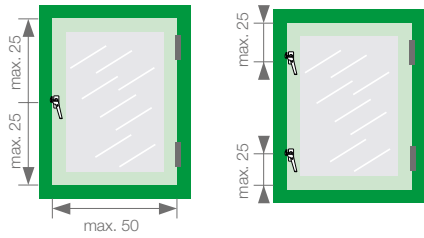

Benodigde montageruimte

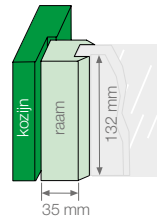

Deur

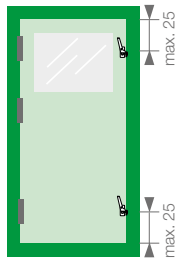

Toepasbare draairichting

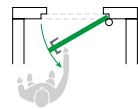

Artikelnummer	Materiaal/kleur/finish	Klein-verpakking	Groot-verpakking	Minimaal bestelaantal	Aanbevolen bevestiging
3320-71-91/6	aluminium geanodiseerd F1	-	50	50	4,0 x 50 mm
3320-71-92/E	aluminium geanodiseerd F2	6	36	6	4,0 x 40 mm

Bijzonderheden:
/6 = seal | /E = EAN sticker direct op product |
bij montage zonder onderlegplaat bevestiging 4,0 x 50 mm



VEILIGHEIDS RAAMSLUITING met sluitplaat 3320

Toepassing

voor draairamen en deuren

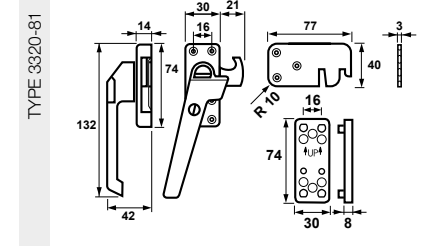
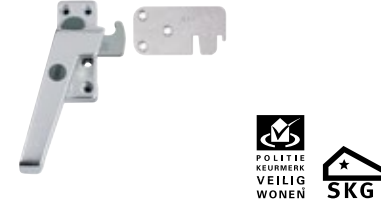

Productpositie

Draairaam

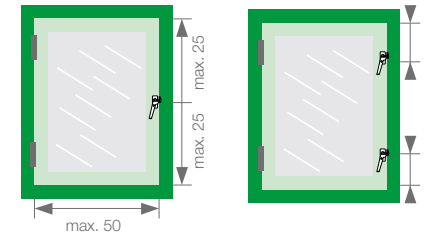

Benodigde montageruimte

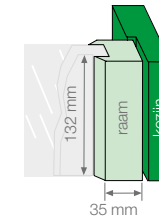

Deur

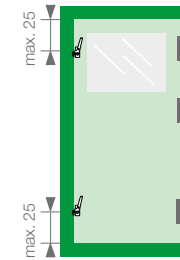

Toepasbare draairichting

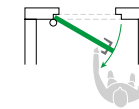

Artikelnummer	Materiaal/kleur/finish	Klein-verpakking	Groot-verpakking	Minimaal bestelaantal	Aanbevolen bevestiging
3320-81-91/6	aluminium geanodiseerd F1	-	50	50	4,0 x 50 mm
3320-81-92/E	aluminium geanodiseerd F2	6	36	6	4,0 x 40 mm

Bijzonderheden:
/6 = seal | /E = EAN sticker direct op product |
bij montage zonder onderlegplaat bevestiging 4,0 x 50 mm

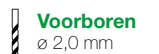

3329 VEILIGHEIDS RAAMSLUITING met opbouwsluitkom



Toepassing
voor draairamen en deuren

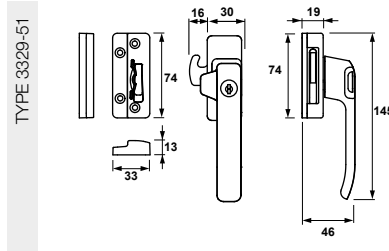

Productpositie

Draairaam

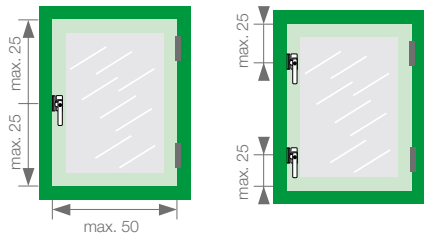

Benodigde montageruimte

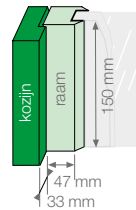

Deur

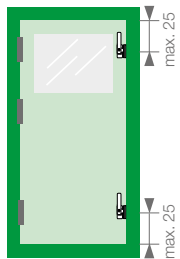

Toepasbare draairichting

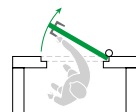

Artikelnummer	Materiaal/kleur/finish	Klein-verpakking	Groot-verpakking	Minimaal bestelaantal	Aanbevolen bevestiging
3329-51-91/GE	aluminium geanodiseerd F1	6	36	6	4,0 x 40 mm / 4,0 x 50 mm

Bijzonderheden:
/GE = gelijksluitend, EAN sticker direct op product

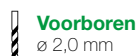

VEILIGHEIDS RAAMSLUITING met opbouwsluitkom 3329



Toepassing
voor draairamen en deuren

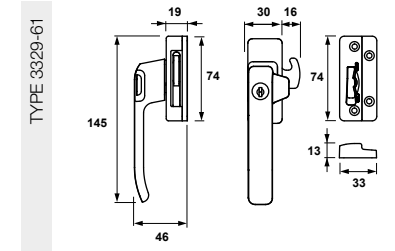

Productpositie

Draairaam

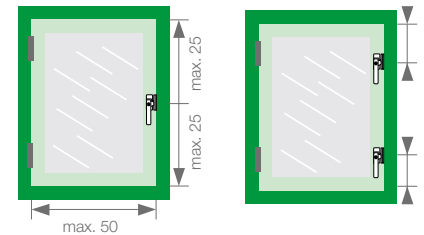

Benodigde montageruimte

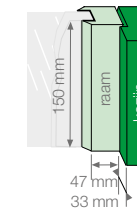

Deur

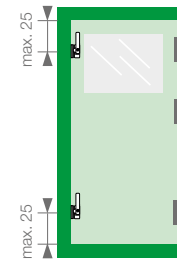

Toepasbare draairichting

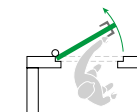

Artikelnummer	Materiaal/kleur/finish	Klein-verpakking	Groot-verpakking	Minimaal bestelaantal	Aanbevolen bevestiging
3329-61-91/GE	aluminium geanodiseerd F1	6	36	6	4,0 x 40 mm / 4,0 x 50 mm

Bijzonderheden:
/GE = gelijksluitend, EAN sticker direct op product



3350 VEILIGHEIDS DRAAI-KIEP RAAMKROK



Toepassing
voor draai-kiepramen



TYPE 3350

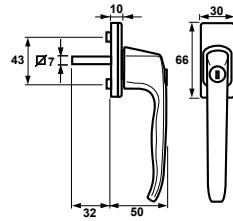

Productpositie

Draai-kiepraam

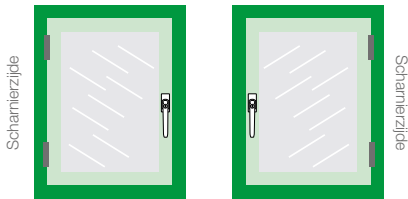

Toepasbare draairichting

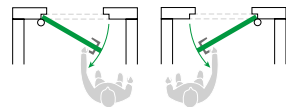

Artikelnummer	Materiaal/kleur/finish	Klein-verpakking	Groot-verpakking	Minimaal bestelaantal	Aanbevolen bevestiging
3350-10-88/E	aluminium wit	10	60	10	4,0 x 40 mm
3350-10-91/E	aluminium geanodiseerd F1	10	60	10	4,0 x 40 mm

Bijzonderheden:
/E = EAN sticker direct op product

Voorboren
ø 2,0 mm

OPLEGSLOT 3011 3011



Toepassing
voor naar buiten draaiende draai-,
klep-, uitzet-, dakramen, deuren en
schuifpuien

TYPE 3011

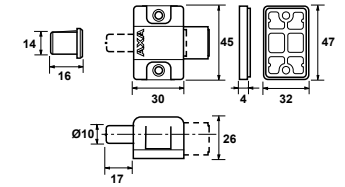

Productpositie

Draairaam

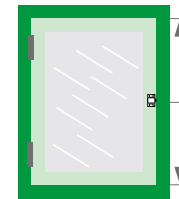

Benodigde montage ruimte

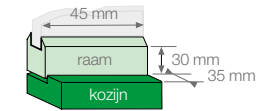

Toepasbare draairichting



Artikelnummer	Materiaal/kleur/finish	Klein-verpakking	Groot-verpakking	Minimaal bestelaantal	Aanbevolen bevestiging
3011-00-68/OLE	zamac wit gelakt	5	100	5	4,0 x 40 mm / 3,0 x 15 mm

Bijzonderheden:
/E = EAN sticker direct op product

Voorboren
ø 2,0 mm

3012 VEILIGHEIDS OPLEGSLOT 3012



Toepassing

voor naar buiten draaiende draai-, klep-, uitzet-, dakramen, deuren en schuifpuien



TYPE 3012

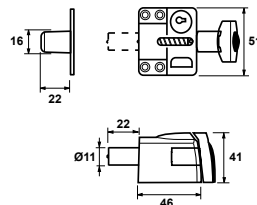

Productpositie

Draairaam

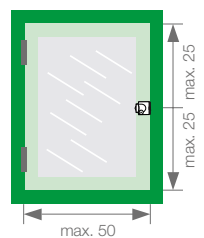

Draairaam 2x

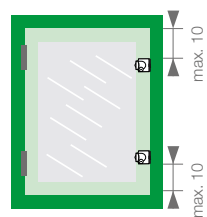

Klepraam

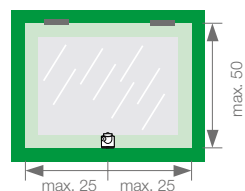

Deur

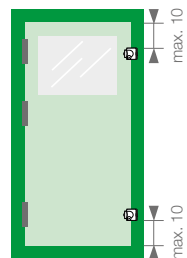

Klepraam 2x

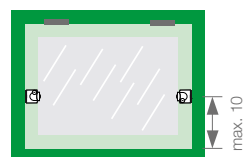

Benodigde montageruimte

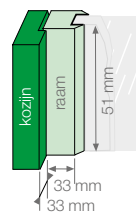

Toepasbare draairichting

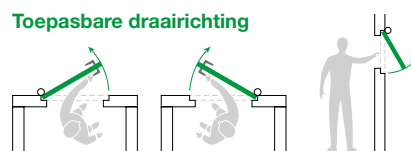

Artikelnummer	Materiaal/kleur/finish	Klein-verpakking	Groot-verpakking	Minimaal bestelaantal	Aanbevolen bevestiging
3012-20-90/6G	zamac verzinkt / kunststof Silverline	-	20	20	4,0 x 40 mm
3012-20-90/G	zamac verzinkt / kunststof Silverline	1	16	16	4,0 x 40 mm
3012-20-97/G	zamac verzinkt / kunststof antraciet	1	16	16	4,0 x 40 mm
3012-20-98/6G	zamac verzinkt / kunststof wit	-	20	20	4,0 x 40 mm
3012-20-98/G	zamac verzinkt / kunststof wit	1	16	16	4,0 x 40 mm

Bijzonderheden:
/6G = seal, gelijksluitend | /G = gelijksluitend



VEILIGHEIDS OPLEGSLOT 3015 3015



Toepassing

voor draairamen en deuren



TYPE 3015

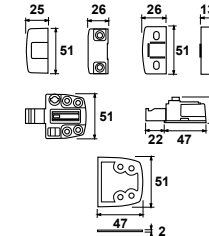

Productpositie

Draairaam

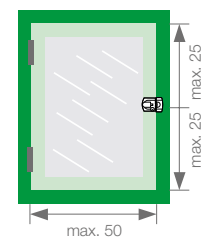

Draairaam 2x

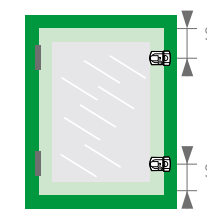

Valraam 1x

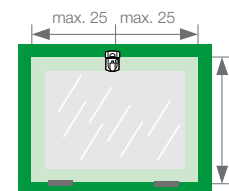

Deur

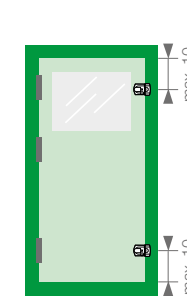

Valraam 2x

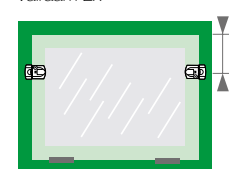

Benodigde montageruimte

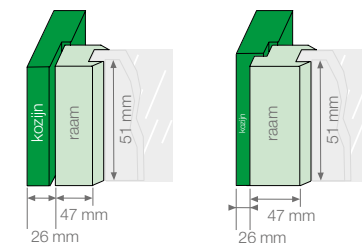

Toepasbare draairichting

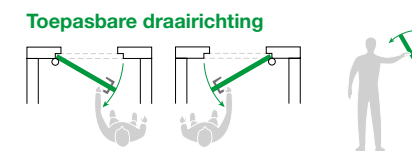

Artikelnummer	Materiaal/kleur/finish	Klein-verpakking	Groot-verpakking	Minimaal bestelaantal	Aanbevolen bevestiging
3015-00-90/G*	zamac verzinkt / kunststof Silverline	1	16	16	4,5 x 40 mm/5,0 x 80 mm
3015-00-98/G*	zamac verzinkt / kunststof wit	1	16	16	4,5 x 40 mm/5,0 x 80 mm
3015-10-90/G**	zamac verzinkt / kunststof Silverline	1	16	16	4,5 x 40 mm/5,0 x 80 mm
3015-10-98/G**	zamac verzinkt / kunststof wit	1	16	16	4,5 x 40 mm/5,0 x 80 mm

Bijzonderheden:
/G* = gelijksluitend, gelijkliggend | /G** = gelijksluitend, opdek



3016 VEILIGHEIDS OPLEGSLOT 3016



Toepassing

voor naar buiten draaiende draai-, klep-, uitzetramen en schuifpuien



TYPE 3016

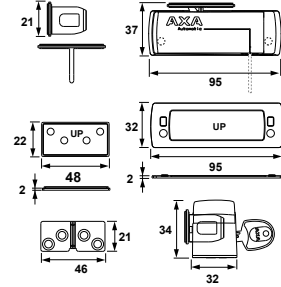

Productpositie

Draairaam 1x

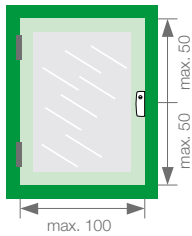

Draairaam 2x

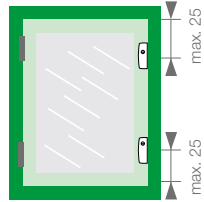

Benodigde montageruimte

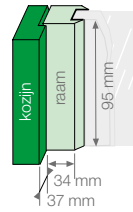

Klepraam 1x

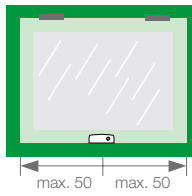

Klepraam 2x

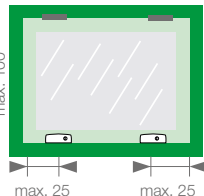

Toepasbare draairichting

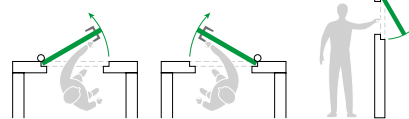

Artikelnummer	Materiaal/kleur/finish	Klein-verpakking	Groot-verpakking	Minimaal bestelaantal	Aanbevolen bevestiging
3016-00-90/G	zamac verzinkt / kunststof Silverline	1	16	16	4,5 x 40 mm / 5,0 x 60 mm
3016-00-98/G	zamac verzinkt / kunststof wit	1	16	16	4,5 x 40 mm / 5,0 x 60 mm

Bijzonderheden:
/G = gelijksluitend

Voorboren
ø 2,5 / 3,0 mm

RAAMKNIP 3380



Toepassing

voor valramen

Toepasbare draairichting

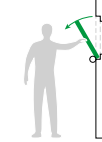

TYPE 3380

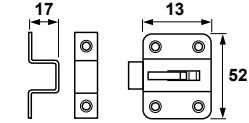

Artikelnummer	Materiaal/kleur/finish	Klein-verpakking	Groot-verpakking	Minimaal bestelaantal	Aanbevolen bevestiging
3380-11-23	staal Topcoat gegalvaniseerd	-	40	40	3,0 x 20 mm
3380-11-23/E	staal Topcoat gegalvaniseerd	-	40	40	3,0 x 20 mm
3380-12-23*	staal Topcoat gegalvaniseerd	-	40	40	3,0 x 20 mm

Bijzonderheden:
/E = EAN sticker direct op product | * = zonder lus

Voorboren
ø 1,5 mm

VALIJZER 3385



Toepassing

voor valramen

TYPE 3385

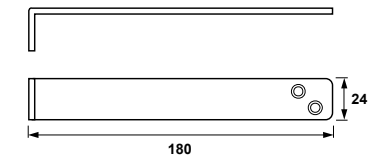

Artikelnummer	Materiaal/kleur/finish	Klein-verpakking	Groot-verpakking	Minimaal bestelaantal	Aanbevolen bevestiging
3385-18-23	staal Topcoat gegalvaniseerd	20	100	20	4,0 x 25 mm

Bijzonderheden:
/GE = gelijksluitend, EAN sticker direct op product

Voorboren
ø 2,0 mm

3760 VENTILATIEROZET



Toepassing
voor muren

TYPE 3760

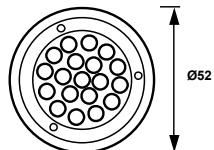

Artikelnummer	Materiaal/kleur/finish	Klein-verpakking	Groot-verpakking	Minimaal bestelaantal	Aanbevolen bevestiging
3760-11-81	RVS	100	1000	100	2,5 x 12 mm
3760-11-81/E	RVS	100	1000	100	2,5 x 12 mm

Bijzonderheden:
/E = EAN sticker direct op product

Voorboren
ø 2,0 mm



ONDERDELEN EN ACCESSOIRES RAAMSLUITINGEN

TYPE 3319-77

Opbouwsluitkom OSL (links)
voor raamsluitingen 3318-61, 3319-61 en 3320-61

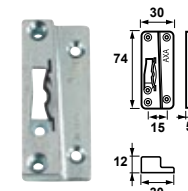

TYPE 3319-67

Opbouwsluitkom OSR (rechts)
voor raamsluitingen 3318-51, 3319-51 en 3320-51

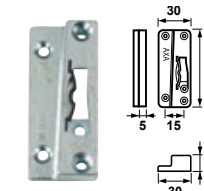

TYPE 3320-77

Opbouwsluitkom OSLS (links)
voor raamsluitingen 3318-61, 3319-61 en 3320-61

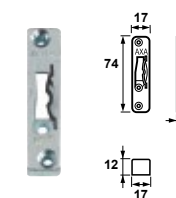

TYPE 3320-67

Opbouwsluitkom OSRS (rechts)
voor raamsluitingen 3318-51, 3319-51 en 3320-51

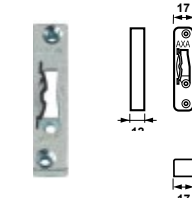

TYPE 3319-97

Inbouwsluitkom ISL (links)
voor raamsluitingen 3318-41, 3319-41 en 3320-41

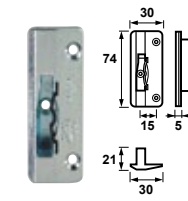

TYPE 3319-87

Inbouwsluitkom ISR (rechts)
voor raamsluitingen 3318-31, 3319-31 en 3320-31

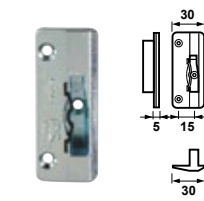

TYPE 3319-93

Sluithaak VSHK
voor raamsluitingen 3318-71, 3318-81, 3319-71, 3319-81, 3320-71 en 3320-81

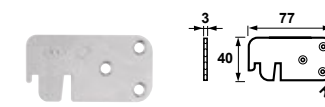

Artikelnummer	Materiaal/kleur/finish	Klein-verpakking	Groot-verpakking	Minimaal bestelaantal	Aanbevolen bevestiging
3319-67-64/E	zamac galvanisch verzinkt	6	60	6	4,0 x 40 mm / 4,5 x 55 mm
3319-77-64/E	zamac galvanisch verzinkt	6	60	6	4,0 x 40 mm / 4,5 x 55 mm
3320-67-64/E	zamac galvanisch verzinkt	6	60	6	4,0 x 40 mm / 4,5 x 55 mm
3320-77-64/E	zamac galvanisch verzinkt	6	60	6	4,0 x 40 mm / 4,5 x 55 mm
3319-87-64/E	zamac galvanisch verzinkt	6	60	6	4,0 x 40 mm
3319-97-64/E	zamac galvanisch verzinkt	6	60	6	4,0 x 40 mm
3319-93-22/E	staal galvanisch verzinkt	20	200	20	4,0 x 40 mm

Bijzonderheden:
/E = EAN sticker direct op product

Voorboren
ø 2,0 mm

ONDERDELEN EN ACCESSOIRES RAAMSLUITINGEN

TYPE 3307-85

Opbouwsluitkom A

voor raamsluitingen 3302, 3308 en 3309

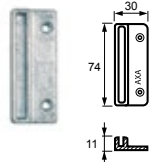

TYPE 3303-92

Sluithaak SH

voor raamsluitingen 3302, 3308 en 3309



TYPE 3307-86

Opbouwsluitkom S

voor raamsluitingen 3302, 3308 en 3309

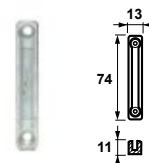

TYPE 3303-93

Sluithaak SHK

voor raamsluitingen 3302, 3308 en 3309



TYPE 3307-87

Opbouwsluitkom N

voor raamsluitingen 3302, 3308 en 3309

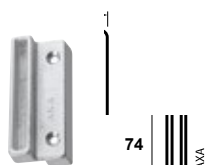

TYPE 3900-00

Sleutel

voor raamsluitingen 3309, 3319, 3329 en oplegsloten 3012, 3015 en 3016



TYPE 3301-84

Sluitplaat E

voor raamsluitingen 3302, 3308 en 3309

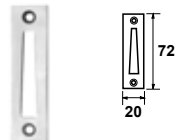

TYPE 2660-91

Sleutel

voor (combi)raamsluiting 3320 en 3355



Artikelnummer	Materiaal/kleur/finish	Klein-verpakking	Groot-verpakking	Minimaal bestelaantal	Aanbevolen bevestiging
3307-85-64/E	zamac galvanisch verzinkt	-	100	100	3,5 x 20 mm
3307-85-64/E	zamac wit	-	100	100	3,5 x 20 mm
3307-86-64	zamac galvanisch verzinkt	-	100	100	3,5 x 20 mm
3307-87-64/E	zamac galvanisch verzinkt	-	100	100	4,0 x 30 mm
3301-84-22	staal galvanisch verzinkt	-	100	100	3,5 x 20 mm
3303-92-23/E	staal Topcoat gegalvaniseerd	100	500	100	3,5 x 20 mm
3303-93-23/E	staal vernikkeld	-	100	100	3,5 x 20 mm
3900-00-37	staal Topcoat gegalvaniseerd	1 (10 st.)	100 (10 st.)	1 (10 st.)	-
2660-91-22	staal galvanisch verzinkt	1 (8 st.)	10 (8 st.)	1 (8 st.)	-

Bijzonderheden:
/E = EAN sticker direct op product

ONDERDELEN EN ACCESSOIRES RAAMSLUITINGEN

TYPE 3305-60

Onderlegplaat

voor raamsluitingen 3302, 3308 en 3309

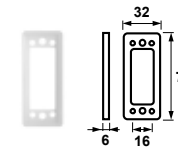

TYPE 3319-80

Onderlegplaat

voor raamsluitingen 3318, 3319 en 3320

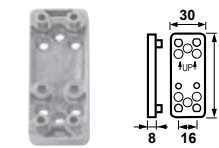

TYPE 3305-90

Onderlegplaat

voor raamsluitingen 3302, 3308 en 3309

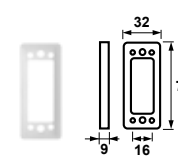

TYPE 3319-82

Onderlegplaat + taptides

voor raamsluitingen 3318, 3319 en 3320

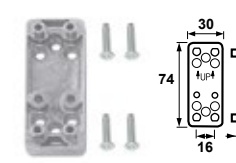

TYPE 3319-00

Onderlegplaat

voor raamsluitingen 3302, 3308, 3309, 3318, 3319 en 3320

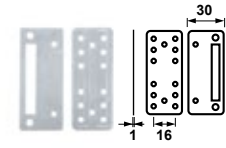

TYPE 3012-18

Onderlegplaat

voor oplegslot 3012

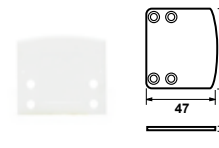

TYPE 3012-30

Opbouwsluitkom

voor oplegslot 3012 voor naar binnendraaiende ramen

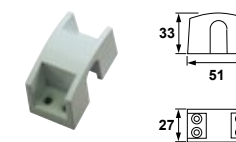

Artikelnummer	Materiaal/kleur/finish	Klein-verpakking	Groot-verpakking	Minimaal bestelaantal	Aanbevolen bevestiging
3305-60-95/E	kunststof wit	-	300	300	-
3305-90-95/E	kunststof wit	-	200	200	-
3319-00-95	kunststof grijs	36	360	36	-
3319-80-64	zamac galvanisch verzinkt	6	48	6	4,0 x 40 mm
3319-82-64	zamac galvanisch verzinkt	-	100	100	4,0 x 40 mm
3012-18-95/E	zamac galvanisch verzinkt	50	500	50	-
3012-30-68	zamac wit	10	80	10	4,0 x 40 mm

Bijzonderheden:
/E = EAN sticker direct op product

Vorboren
ø 2,0 mm



Deurbeslag

Inhoudsopgave

Pagina

Premium veiligheidsbeslag met anti-kerntrek	184
Curve veiligheidsbeslag met anti-kerntrek	203
Curve veiligheidsbeslag	217
Deurkrukken voor buiten en binnen	235
Deurkrukken voor binnen	242
Curve Klik binnendeurbeslag	246
Curve binnendeurbeslag	257
Briefplaten	267
Deurknoppen	269
Onderdelen en accessoires deurbeslag	270



6662 PREMIUM VEILIGHEIDSBESLAG D-duwer Arrow



Toepassing

voor voordeuren, 38 tot 67 mm dik



EN 1906
Security Klasse 3

TYPE 6662-20

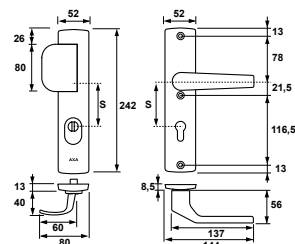

Productpositie

Deur

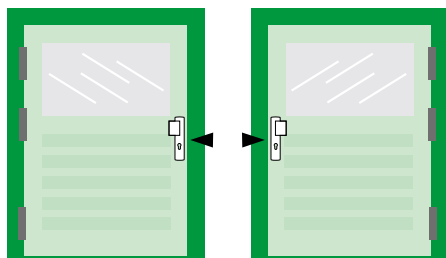

Toepasbare draairichting

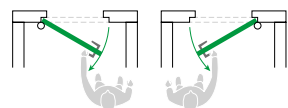

Artikelnummer	Materiaal/kleur/finish	PC	Klein-verpakking	Groot-verpakking	Minimaal bestelaantal	Aanbevolen bevestiging
6662-20-11/55*	aluminium geslepen F1	55	1	4	1	M6 x 50 mm / M6 x 70 mm
6662-20-11/72*	aluminium geslepen F1	72	1	4	1	M6 x 50 mm / M6 x 70 mm
6662-20-11/92*	aluminium geslepen F1	92	1	4	1	M6 x 50 mm / M6 x 70 mm

Bijzonderheden:
* = anti-kern trek en vast-geveerde kruk



PREMIUM VEILIGHEIDSBESLAG D-duwer Flow 6662



Toepassing

voor voordeuren, 38 tot 67 mm dik



EN 1906
Security Klasse 3

TYPE 6662-23

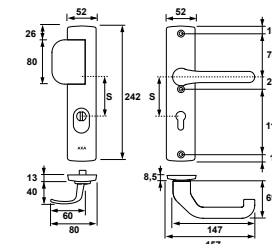

Productpositie

Deur

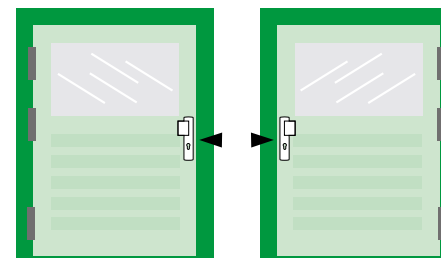

Toepasbare draairichting

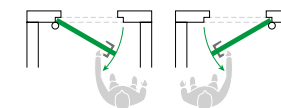

Artikelnummer	Materiaal/kleur/finish	PC	Klein-verpakking	Groot-verpakking	Minimaal bestelaantal	Aanbevolen bevestiging
6662-23-11/55	aluminium geslepen F1	55	1	4	1	M6 x 50 mm / M6 x 70 mm
6662-23-11/72	aluminium geslepen F1	72	1	4	1	M6 x 50 mm / M6 x 70 mm
6662-23-11/92	aluminium geslepen F1	92	1	4	1	M6 x 50 mm / M6 x 70 mm

Bijzonderheden:
* = anti-kern trek en vast-geveerde kruk

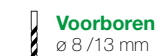

6662 PREMIUM VEILIGHEIDSBESLAG kruk Wing Arrow



Toepassing

voor voordeuren, knop-kruk bedienbaar, 38 tot 67 mm dik



EN 1906 Security Klasse 3

TYPE 6662-40

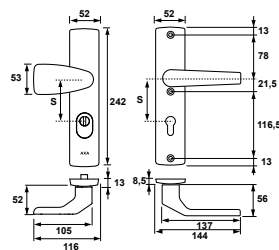

Productpositie

Deur

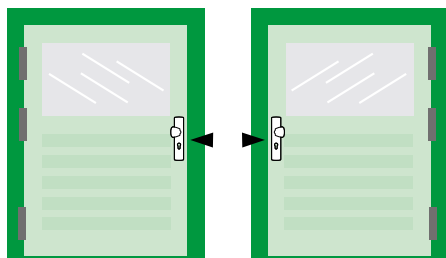

Toepasbare draairichting

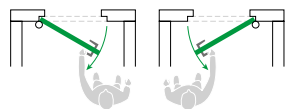

Artikelnummer	Materiaal/kleur/finish	PC	Klein-verpakking	Groot-verpakking	Minimaal bestelaantal	Aanbevolen bevestiging
6662-40-11/72*	aluminium geslepen F1	72	1	4	1	M6 x 50 mm / M6 x 70 mm
6662-40-11/92*	aluminium geslepen F1	92	1	4	1	M6 x 50 mm / M6 x 70 mm

Bijzonderheden:
* = anti-kern trek en vast-geveerde kruk



PREMIUM VEILIGHEIDSBESLAG kruk Wing Flow 6662



Toepassing

voor voordeuren, knop-kruk bedienbaar, 38 tot 67 mm dik



EN 1906 Security Klasse 3

TYPE 6662-43

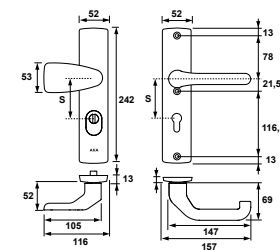

Productpositie

Deur

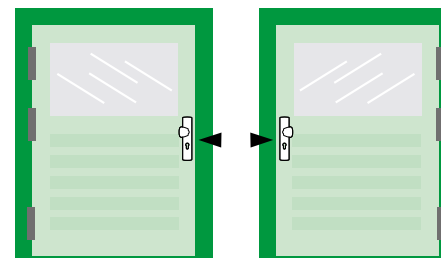

Toepasbare draairichting

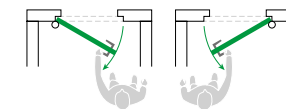

Artikelnummer	Materiaal/kleur/finish	PC	Klein-verpakking	Groot-verpakking	Minimaal bestelaantal	Aanbevolen bevestiging
6662-43-11/72*	aluminium geslepen F1	72	1	4	1	M6 x 50 mm / M6 x 70 mm
6662-43-11/92*	aluminium geslepen F1	92	1	4	1	M6 x 50 mm / M6 x 70 mm

Bijzonderheden:
* = anti-kern trek en vast-geveerde kruk

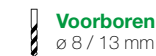

6662 PREMIUM VEILIGHEIDSBESLAG Wing-knop Arrow



Toepassing

voor voordeuren, 38 tot 67 mm dik



EN 1906
Security Klasse 3

TYPE 6662-50

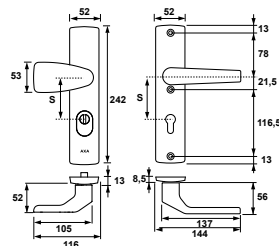

Productpositie

Deur

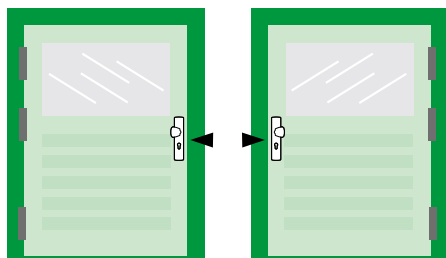

Toepasbare draairichting

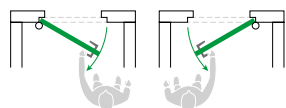

Artikelnummer	Materiaal/kleur/finish	PC	Klein-verpakking	Groot-verpakking	Minimaal bestelaantal	Aanbevolen bevestiging
6662-50-11/72*	aluminium geslepen F1	72	1	4	1	M6 x 50 mm / M6 x 70 mm
6662-50-11/92*	aluminium geslepen F1	92	1	4	1	M6 x 50 mm / M6 x 70 mm

Bijzonderheden:

* = anti-kern trek en vast-geveerde kruk

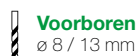

PREMIUM VEILIGHEIDSBESLAG Wing-knop Flow 6662



Toepassing

voor voordeuren, 38 tot 67 mm dik



EN 1906
Security Klasse 3

TYPE 6662-53

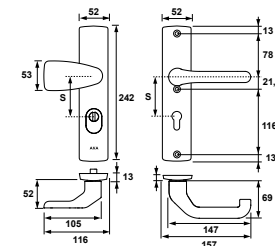

Productpositie

Deur

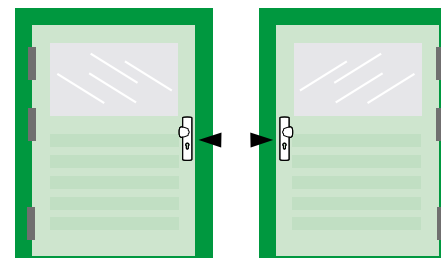

Toepasbare draairichting

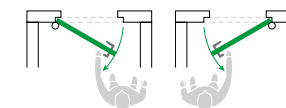

Artikelnummer	Materiaal/kleur/finish	PC	Klein-verpakking	Groot-verpakking	Minimaal bestelaantal	Aanbevolen bevestiging
6662-53-11/72*	aluminium geslepen F1	72	1	4	1	M6 x 50 mm / M6 x 70 mm
6662-53-11/92*	aluminium geslepen F1	92	1	4	1	M6 x 50 mm / M6 x 70 mm

Bijzonderheden:

* = anti-kern trek en vast-geveerde kruk

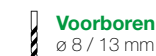

6662 PREMIUM VEILIGHEIDSBESLAG kruk Arrow

Toepassing
voor achterdeuren, 38 tot 67 mm dik



POLITIE KEURMERK VEILIG WONEN
SKG
EN 1906 Security Klasse 3

TYPE 6662-60

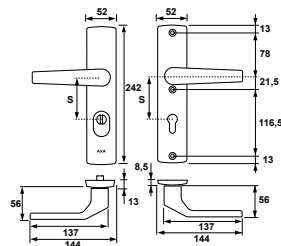

Productpositie

Deur

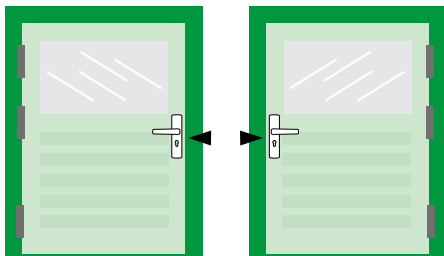

Toepasbare draairichting

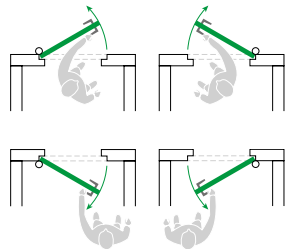

Artikelnummer	Materiaal/kleur/finish	PC	Klein-verpakking	Groot-verpakking	Minimaal bestelaantal	Aanbevolen bevestiging
6662-60-11/55*	aluminium geslepen F1	55	1	4	1	M6 x 50 mm / M6 x 70 mm
6662-60-11/72*	aluminium geslepen F1	72	1	4	1	M6 x 50 mm / M6 x 70 mm
6662-60-11/92*	aluminium geslepen F1	92	1	4	1	M6 x 50 mm / M6 x 70 mm

Bijzonderheden:
* = anti-kern trek en vast-geveerde kruk

Voorboren
ø 8 / 13 mm

PREMIUM VEILIGHEIDSBESLAG kruk Flow 6662

Toepassing
voor achterdeuren, 38 tot 67 mm dik



POLITIE KEURMERK VEILIG WONEN
SKG
EN 1906 Security Klasse 3

TYPE 6662-63

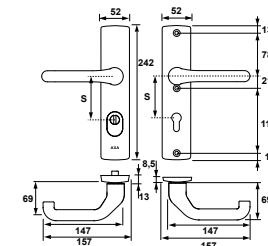

Productpositie

Deur

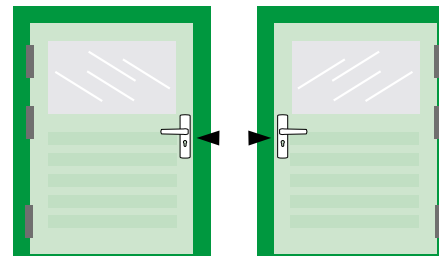

Toepasbare draairichting

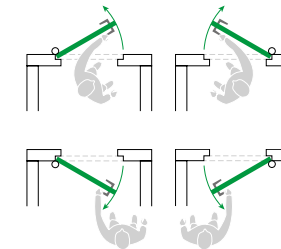

Artikelnummer	Materiaal/kleur/finish	PC	Klein-verpakking	Groot-verpakking	Minimaal bestelaantal	Aanbevolen bevestiging
6662-63-11/55*	aluminium geslepen F1	55	1	4	1	M6 x 50 mm / M6 x 70 mm
6662-63-11/72*	aluminium geslepen F1	72	1	4	1	M6 x 50 mm / M6 x 70 mm
6662-63-11/92*	aluminium geslepen F1	92	1	4	1	M6 x 50 mm / M6 x 70 mm

Bijzonderheden:
* = anti-kern trek en vast-geveerde kruk

Voorboren
ø 8 / 13 mm

6652 PREMIUM VEILIGHEIDSBESLAG comfort D-duwer Arrow

PREMIUM VEILIGHEIDSBESLAG comfort kruk Wing Flow 6652

Toepassing
voor voordeuren, 38 tot 67 mm dik



POLITIE KEURMERK VEILIG WONEN
SKG
EN 1906
Security Klasse 3

TYPE 6652-23

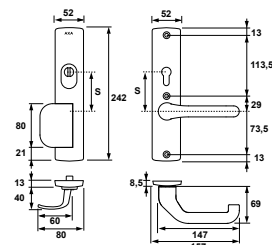

Toepassing
voor voordeuren, knop-kruk bedienbaar, 38 tot 67 mm dik



POLITIE KEURMERK VEILIG WONEN
SKG
EN 1906
Security Klasse 3

TYPE 6652-43

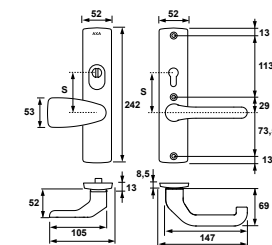

Productpositie

Deur

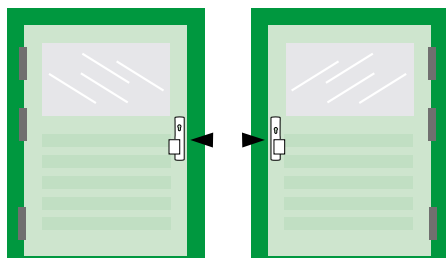

Productpositie

Deur

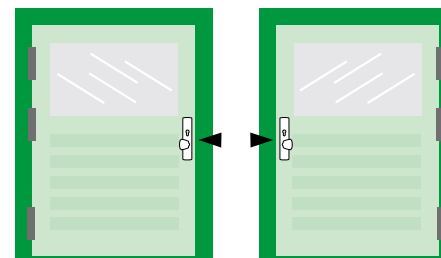

Toepasbare draairichting

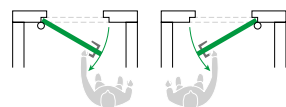

Toepasbare draairichting

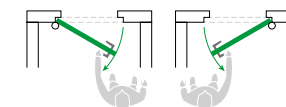

Artikelnummer	Materiaal/kleur/finish	PC	Klein-verpakking	Groot-verpakking	Minimaal bestelaantal	Aanbevolen bevestiging
6652-23-11/72*	aluminium geslepen F1	72	1	4	1	M6 x 50 mm / M6 x 70 mm

Bijzonderheden:
* = anti-kern trek en vast-geveerde kruk

Voorboren
ø 8 / 13 mm

Artikelnummer	Materiaal/kleur/finish	PC	Klein-verpakking	Groot-verpakking	Minimaal bestelaantal	Aanbevolen bevestiging
6652-43-11/72*	aluminium geslepen F1	72	1	4	1	M6 x 50 mm / M6 x 70 mm

Bijzonderheden:
* = anti-kern trek en vast-geveerde kruk

Voorboren
ø 8 / 13 mm

6652 PREMIUM VEILIGHEIDSBESLAG comfort kruk Flow



Toepassing

voor achterdeuren, 38 tot 67 mm dik



EN 1906
Security Klasse 3

TYPE 6652-63

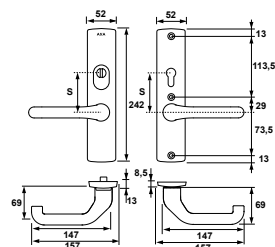

Productpositie

Deur

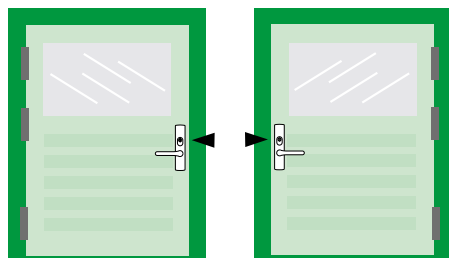

Toepasbare draairichting

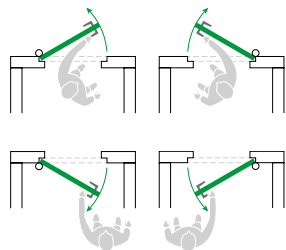

Artikelnummer	Materiaal/kleur/finish	PC	Klein-verpakking	Groot-verpakking	Minimaal bestelaantal	Aanbevolen bevestiging
6652-63-11/72*	aluminium geslepen F1	72	1	4	1	M6 x 50 mm / M6 x 70 mm

Bijzonderheden:
* = anti-kern trek en vast-geveerde kruk

Voorboren
ø 8 / 13 mm

PREMIUM VEILIGHEIDSBESLAG smal D-duwer Arrow 6762



Toepassing

voor voordeuren, 38 tot 67 mm dik



EN 1906
Security Klasse 3

TYPE 6762-20

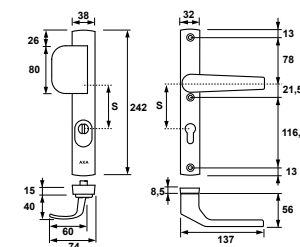

Productpositie

Deur

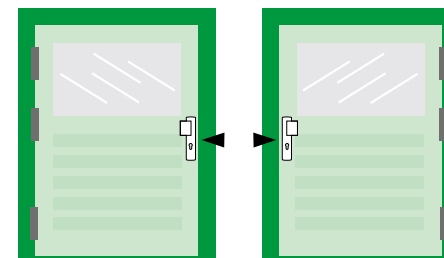

Toepasbare draairichting

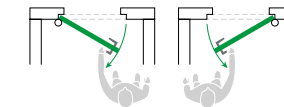

Artikelnummer	Materiaal/kleur/finish	PC	Klein-verpakking	Groot-verpakking	Minimaal bestelaantal	Aanbevolen bevestiging
6762-20-11/55*	aluminium geslepen F1	55	1	4	1	M6 x 50 mm / M6 x 70 mm
6762-20-11/72*	aluminium geslepen F1	72	1	4	1	M6 x 50 mm / M6 x 70 mm
6762-20-11/92*	aluminium geslepen F1	92	1	4	1	M6 x 50 mm / M6 x 70 mm

Bijzonderheden:
* = anti-kern trek en vast-geveerde kruk

Voorboren
ø 8 / 13 mm

6762 PREMIUM VEILIGHEIDSBESLAG smal D-duwer Flow



Toepassing

voor voordeuren, 38 tot 67 mm dik



EN 1906
Security Klasse 3

TYPE 6762-23

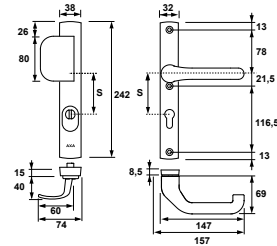

Productpositie

Deur

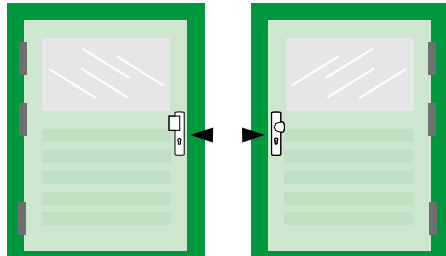

Toepasbare draairichting

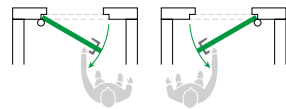

Artikelnummer	Materiaal/kleur/finish	PC	Klein-verpakking	Groot-verpakking	Minimaal bestelaantal	Aanbevolen bevestiging
6762-23-11/55*	aluminium geslepen F1	55	1	4	1	M6 x 50 mm / M6 x 70 mm
6762-23-11/72*	aluminium geslepen F1	72	1	4	1	M6 x 50 mm / M6 x 70 mm
6762-23-11/92*	aluminium geslepen F1	92	1	4	1	M6 x 50 mm / M6 x 70 mm

Bijzonderheden:
* = anti-kern trek en vast-geveerde kruk

Voorboren
ø 8 / 13 mm

PREMIUM VEILIGHEIDSBESLAG smal kruk Wing Arrow 6762



Toepassing

voor voordeuren, knop-kruk bedienbaar, 38 tot 67 mm dik



EN 1906
Security Klasse 3

TYPE 6762-40

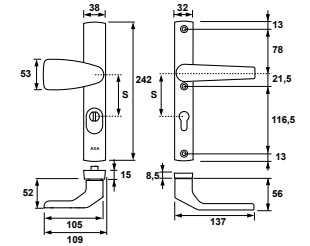

Productpositie

Deur

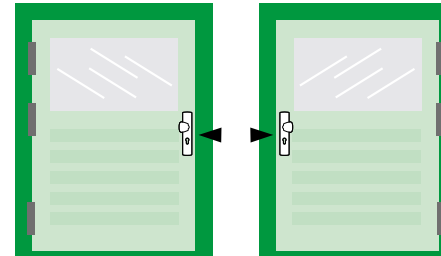

Toepasbare draairichting

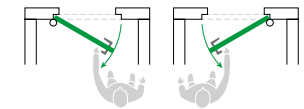

Artikelnummer	Materiaal/kleur/finish	PC	Klein-verpakking	Groot-verpakking	Minimaal bestelaantal	Aanbevolen bevestiging
6762-40-11/72*	aluminium geslepen F1	72	1	4	1	M6 x 50 mm / M6 x 70 mm
6762-40-11/92*	aluminium geslepen F1	92	1	4	1	M6 x 50 mm / M6 x 70 mm

Bijzonderheden:
* = anti-kern trek en vast-geveerde kruk

Voorboren
ø 8 / 13 mm

6762 PREMIUM VEILIGHEIDSBESLAG smal kruk Wing Flow



Toepassing

voor voordeuren, knop-kruk bedienbaar, 38 tot 67 mm dik



EN 1906
Security Klasse 3

TYPE 6762-43

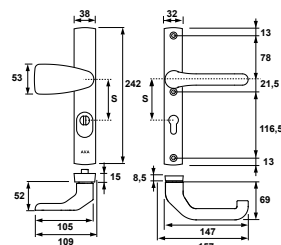

Productpositie

Deur

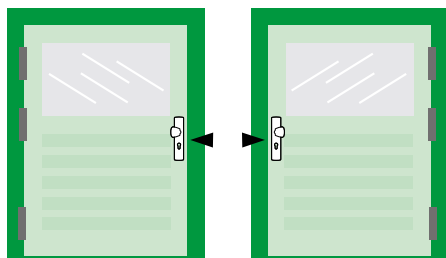

Toepasbare draairichting

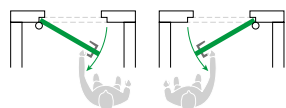

Artikelnummer	Materiaal/kleur/finish	PC	Klein-verpakking	Groot-verpakking	Minimaal bestelaantal	Aanbevolen bevestiging
6762-43-11/72*	aluminium geslepen F1	72	1	4	1	M6 x 50 mm / M6 x 70 mm
6762-43-11/92*	aluminium geslepen F1	92	1	4	1	M6 x 50 mm / M6 x 70 mm

Bijzonderheden:
* = anti-kerntrek en vast-geveerde kruk



PREMIUM VEILIGHEIDSBESLAG smal Wing-knop Arrow 6762



Toepassing

voor voordeuren, 38 tot 67 mm dik



EN 1906
Security Klasse 3

TYPE 6762-50

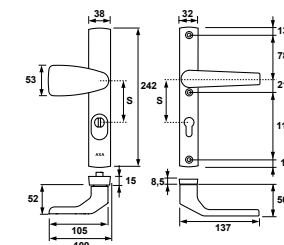

Productpositie

Deur

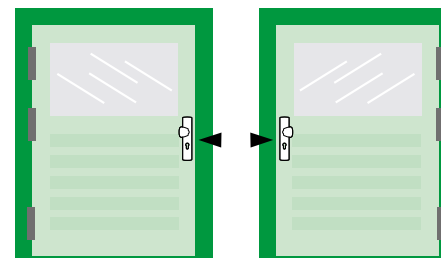

Toepasbare draairichting

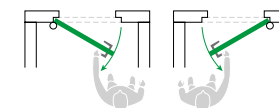

Artikelnummer	Materiaal/kleur/finish	PC	Klein-verpakking	Groot-verpakking	Minimaal bestelaantal	Aanbevolen bevestiging
6762-50-11/72*	aluminium geslepen F1	72	1	4	1	M6 x 50 mm / M6 x 70 mm
6762-50-11/92*	aluminium geslepen F1	92	1	4	1	M6 x 50 mm / M6 x 70 mm

Bijzonderheden:
* = anti-kerntrek en vast-geveerde kruk



6762 PREMIUM VEILIGHEIDSBESLAG smal Wing-knop Flow



Toepassing

voor voordeuren, 38 tot 67 mm dik



EN 1906
Security Klasse 3

TYPE 6762-53

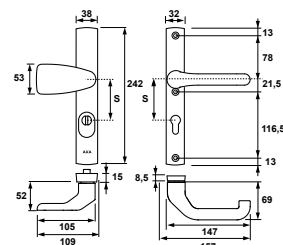

Productpositie

Deur

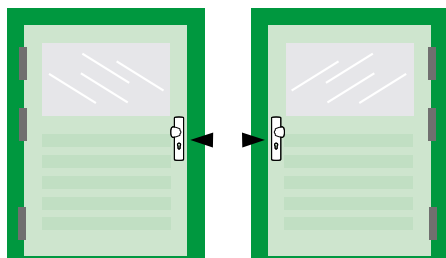

Toepasbare draairichting

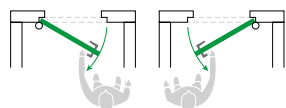

Artikelnummer	Materiaal/kleur/finish	PC	Klein-verpakking	Groot-verpakking	Minimaal bestelaantal	Aanbevolen bevestiging
6762-53-11/72*	aluminium geslepen F1	72	1	4	1	M6 x 50 mm / M6 x 70 mm
6762-53-11/92*	aluminium geslepen F1	92	1	4	1	M6 x 50 mm / M6 x 70 mm

Bijzonderheden:
* = anti-kern trek en vast-geveerde kruk



PREMIUM VEILIGHEIDSBESLAG smal kruk Arrow 6762



Toepassing

voor achterdeuren, 38 tot 67 mm dik



EN 1906
Security Klasse 3

TYPE 6762-60

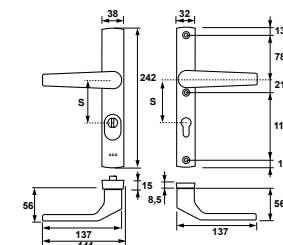

Productpositie

Deur

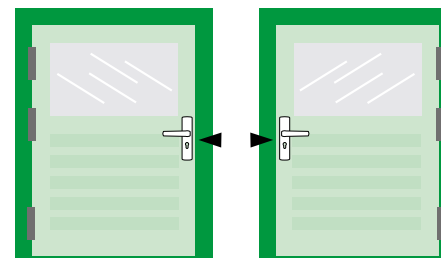

Toepasbare draairichting

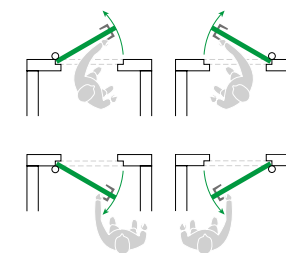

Artikelnummer	Materiaal/kleur/finish	PC	Klein-verpakking	Groot-verpakking	Minimaal bestelaantal	Aanbevolen bevestiging
6762-60-11/55*	aluminium geslepen F1	55	1	4	1	M6 x 50 mm / M6 x 70 mm
6762-60-11/72*	aluminium geslepen F1	72	1	4	1	M6 x 50 mm / M6 x 70 mm
6762-60-11/92*	aluminium geslepen F1	92	1	4	1	M6 x 50 mm / M6 x 70 mm

Bijzonderheden:
* = anti-kern trek en vast-geveerde kruk



6762 PREMIUM VEILIGHEIDSBESLAG smal kruk Flow



Toepassing

voor achterdeuren, 38 tot 67 mm dik



EN 1906
Security Klasse 3

TYPE 6762-63

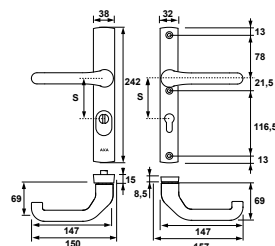

Productpositie

Deur

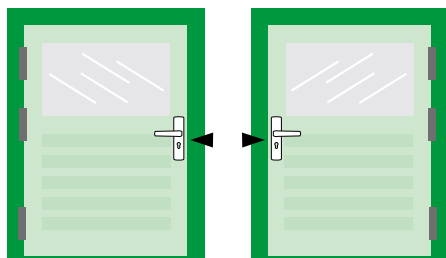

Toepasbare draairichting

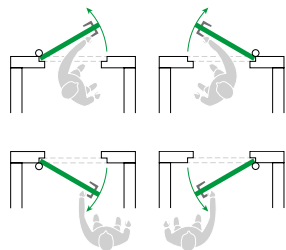

Artikelnummer	Materiaal/kleur/finish	PC	Klein-verpakking	Groot-verpakking	Minimaal bestelaantal	Aanbevolen bevestiging
6762-63-11/55*	aluminium geslepen F1	55	1	4	1	M6 x 50 mm / M6 x 70 mm
6762-63-11/72*	aluminium geslepen F1	72	1	4	1	M6 x 50 mm / M6 x 70 mm
6762-63-11/92*	aluminium geslepen F1	92	1	4	1	M6 x 50 mm / M6 x 70 mm

Bijzonderheden:
* = anti-kerntrek en vast-geveerde kruk

Voorboren
ø 8 / 13 mm

CURVE VEILIGHEIDSBESLAG D-duwer anti-kerntrek 6665



Toepassing

voor voordeuren, 38 tot 40 mm dik



TYPE 6665-35

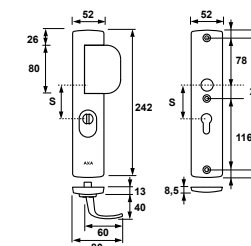

Productpositie

Deur

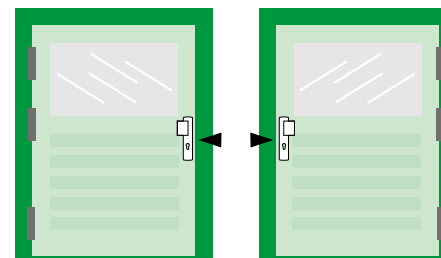

Toepasbare draairichting

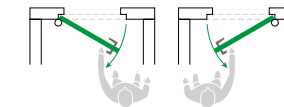

Artikelnummer	Materiaal/kleur/finish	PC	Klein-verpakking	Groot-verpakking	Minimaal bestelaantal	Aanbevolen bevestiging
6665-35-11/55	aluminium geslepen F1	55	1	10	1	M6 x 50 mm
6665-35-11/55K	aluminium geslepen F1	55	1	10	1	M6 x 50 mm / M6 x 70 mm
6665-35-11/72	aluminium geslepen F1	72	1	10	1	M6 x 50 mm
6665-35-11/72K	aluminium geslepen F1	72	1	10	1	M6 x 50 mm / M6 x 70 mm

Bijzonderheden:
K = inclusief Blokkruk en M6 x70 mm bouten voor deurdikte tot 60 mm

Voorboren
ø 8 / 13 mm

6665 CURVE VEILIGHEIDSBESLAG S-knop anti-kerntrek



Toepassing

voor voordeuren, 38 tot 40 mm dik



TYPE 6665-51

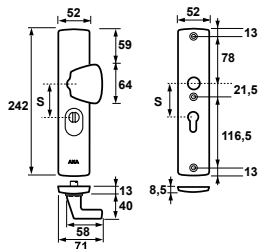

Productpositie

Deur

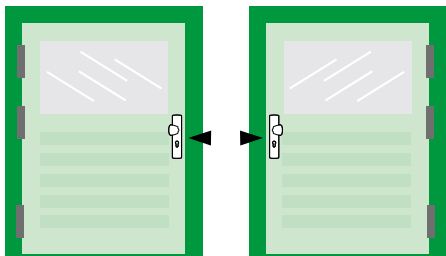

Toepasbare draairichting

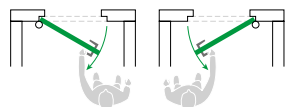

Artikelnummer	Materiaal/kleur/finish	PC	Klein-verpakking	Groot-verpakking	Minimaal bestelaantal	Aanbevolen bevestiging
6665-51-11/55	aluminium geslepen F1	55	1	12	1	M6 x 50 mm
6665-51-11/55K	aluminium geslepen F1	55	1	10	1	M6 x 50 mm / M6 x 70 mm
6665-51-29/55K	aluminium geslepen Inox	55	1	10	1	M6 x 50 mm / M6 x 70 mm
6665-51-11/72	aluminium geslepen F1	72	1	12	1	M6 x 50 mm
6665-51-11/72K	aluminium geslepen F1	72	1	10	1	M6 x 50 mm / M6 x 70 mm
6665-51-29/72K	aluminium geslepen Inox	72	1	10	1	M6 x 50 mm / M6 x 70 mm
6665-51-11/85	aluminium geslepen F1	85	1	12	1	M6 x 50 mm
6665-51-11/92	aluminium geslepen F1	92	1	12	1	M6 x 50 mm

Bijzonderheden:
K = inclusief Blokkruk en M6 x70 mm bouten en duwerstift 90 mm voor deurdikte tot 60 mm



CURVE VEILIGHEIDSBESLAG kruk anti-kerntrek 6665



Toepassing

voor achterdeuren, 38 tot 60 mm dik



TYPE 6665-10

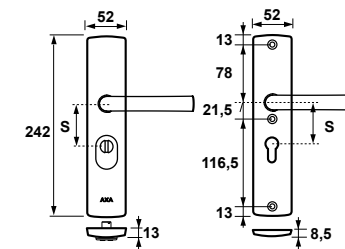

Productpositie

Deur

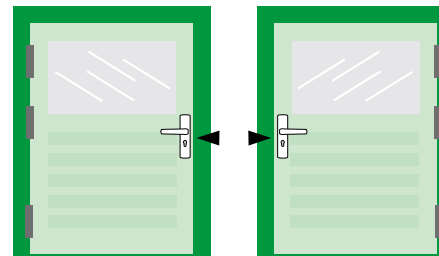

Toepasbare draairichting

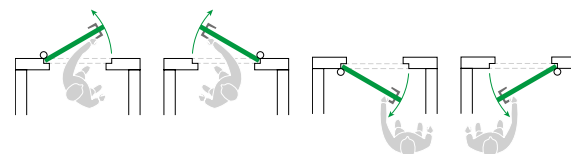

Artikelnummer	Materiaal/kleur/finish	PC	Klein-verpakking	Groot-verpakking	Minimaal bestelaantal	Aanbevolen bevestiging
6665-10-11/55K	aluminium geslepen F1	55	1	10	1	M6 x 50 mm / M6 x 70 mm
6665-10-29/55K	aluminium geslepen Inox	55	1	10	1	M6 x 50 mm / M6 x 70 mm
6665-10-11/72K	aluminium geslepen F1	72	1	10	1	M6 x 50 mm / M6 x 70 mm
6665-10-29/72K	aluminium geslepen Inox	72	1	10	1	M6 x 50 mm / M6 x 70 mm
6665-10-11/92K	aluminium geslepen F1	92	1	10	1	M6 x 50 mm / M6 x 70 mm

Bijzonderheden:
K = inclusief Blokkruk en M6 x70 mm bouten en duwerstift 90 mm



6675 CURVE VEILIGHEIDSBESLAG S-knop kort anti-kemtrek

CURVE VEILIGHEIDSBESLAG kruk kort anti-kemtrek 6675

Toepassing

voor voordeuren, 38 tot 60 mm dik



TYPE 6675-51

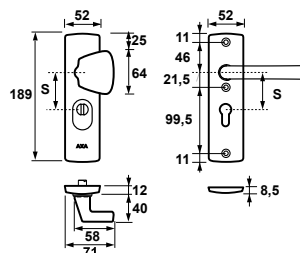

Toepassing

voor achterdeuren, 38 tot 60 mm dik



TYPE 6675-10

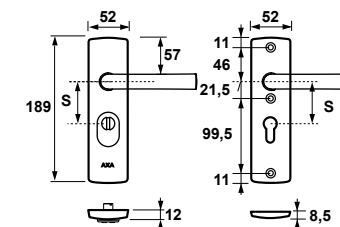

Productpositie

Deur

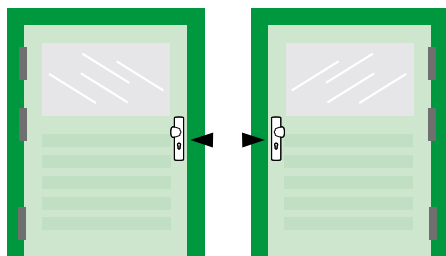

Productpositie

Deur

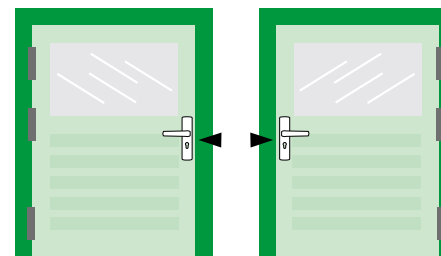

Toepasbare draairichting

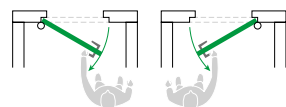

Toepasbare draairichting

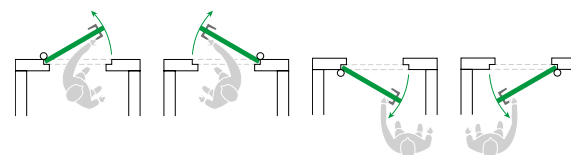

Artikelnummer	Materiaal/kleur/finish	PC	Klein-verpakking	Groot-verpakking	Minimaal bestelaantal	Aanbevolen bevestiging
6675-51-11/55K	aluminium geslepen F1	55	1	10	1	M6 x 50 mm / M6 x 70 mm
6675-51-29/55K	aluminium geslepen Inox	55	1	10	1	M6 x 50 mm / M6 x 70 mm
6675-51-11/72K	aluminium geslepen F1	72	1	10	1	M6 x 50 mm / M6 x 70 mm
6675-51-29/72K	aluminium geslepen Inox	72	1	10	1	M6 x 50 mm / M6 x 70 mm

Bijzonderheden:
K = inclusief Blokkruk en M6 x70 mm bouten en duwerstift 90 mm



Artikelnummer	Materiaal/kleur/finish	PC	Klein-verpakking	Groot-verpakking	Minimaal bestelaantal	Aanbevolen bevestiging
6675-10-11/55K	aluminium geslepen F1	55	1	10	1	M6 x 50 mm / M6 x 70 mm
6675-10-29/55K	aluminium geslepen Inox	55	1	10	1	M6 x 50 mm / M6 x 70 mm
6675-10-11/72K	aluminium geslepen F1	72	1	10	1	M6 x 50 mm / M6 x 70 mm
6675-10-29/72K	aluminium geslepen Inox	72	1	10	1	M6 x 50 mm / M6 x 70 mm

Bijzonderheden:
K = inclusief Blokkruk en M6 x70 mm bouten



6765 CURVE VEILIGHEIDSBESLAG smal D-duwer anti-kerntrek



Toepassing

voor voordeuren, 38 tot 60 mm dik



TYPE 6765-95

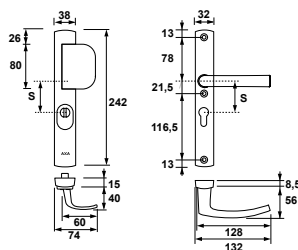

Productpositie

Deur

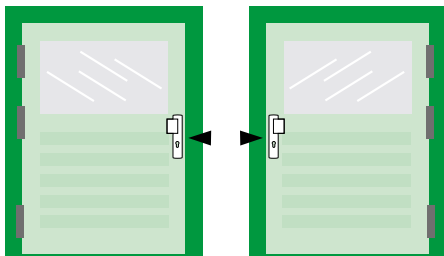

Toepasbare draairichting

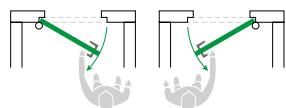

Artikelnummer	Materiaal/kleur/finish	PC	Klein-verpakking	Groot-verpakking	Minimaal bestelaantal	Aanbevolen bevestiging
6765-35-11/55K	aluminium geslepen F1	55	1	10	1	M6 x 50 mm / M6 x 70 mm
6765-35-11/72K	aluminium geslepen F1	72	1	10	1	M6 x 50 mm / M6 x 70 mm
6765-35-11/92K	aluminium geslepen F1	92	1	10	1	M6 x 50 mm / M6 x 70 mm

Bijzonderheden:
K = inclusief Blokkruk en M6 x70 mm bouten en duwerstift 90 mm

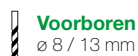

CURVE VEILIGHEIDSBESLAG smal kruk anti-kerntrek 6765



Toepassing

voor achterdeuren, 38 tot 60 mm dik



TYPE 6765-10

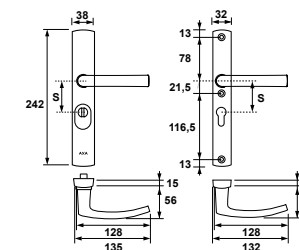

Productpositie

Deur

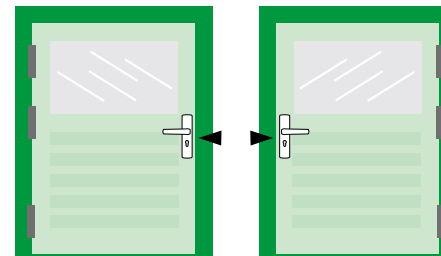

Toepasbare draairichting

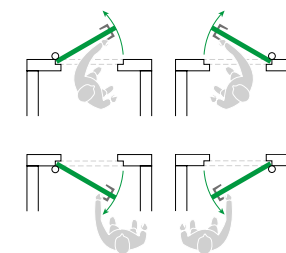

Artikelnummer	Materiaal/kleur/finish	PC	Klein-verpakking	Groot-verpakking	Minimaal bestelaantal	Aanbevolen bevestiging
6765-10-11/55K	aluminium geslepen F1	55	1	10	1	M6 x 50 mm / M6 x 70 mm
6765-10-11/72K	aluminium geslepen F1	72	1	10	1	M6 x 50 mm / M6 x 70 mm
6765-10-11/92K	aluminium geslepen F1	92	1	10	1	M6 x 50 mm / M6 x 70 mm

Bijzonderheden:
K = inclusief Blokkruk en M6 x70 mm bouten

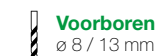

6655 CURVE VEILIGHEIDSBESLAG comfort S-knop anti-kerntrek



Toepassing

voor voordeuren, 38 tot 40 mm dik



TYPE 6655-51

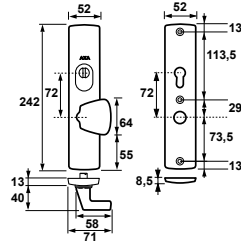

Productpositie

Deur

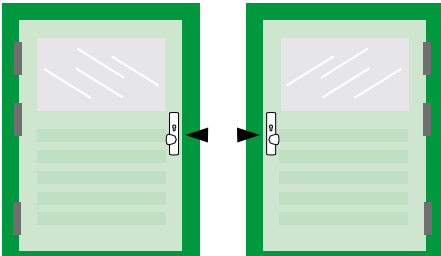

Toepasbare draairichting

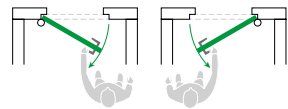

Artikelnummer	Materiaal/kleur/finish	PC	Klein-verpakking	Groot-verpakking	Minimaal bestelaantal	Aanbevolen bevestiging
6655-51-11/72	aluminium geslepen F1	72	1	12	1	M6 x 50 mm

Voorboren
ø 8 / 13 mm

CURVE VEILIGHEIDSSCHILDEN anti-kerntrek 6665



Toepassing

voor achterdeuren, 38 tot 40 mm dik



TYPE 6665-10

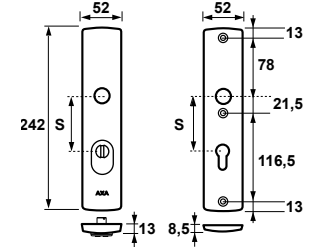

Productpositie

Deur

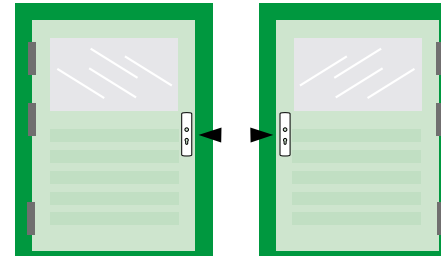

Toepasbare draairichting

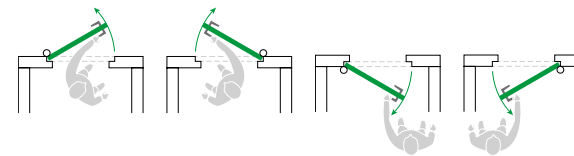

Artikelnummer	Materiaal/kleur/finish	PC	Klein-verpakking	Groot-verpakking	Minimaal bestelaantal	Aanbevolen bevestiging
6665-10-11/55	aluminium geslepen F1	55	1	12	1	M6 x 50 mm
6665-10-11/72	aluminium geslepen F1	72	1	12	1	M6 x 50 mm
6665-10-11/85	aluminium geslepen F1	85	1	12	1	M6 x 50 mm
6665-10-11/92	aluminium geslepen F1	92	1	12	1	M6 x 50 mm

Voorboren
ø 8 / 13 mm

6675 CURVE VEILIGHEIDSSCHILDEN anti-kerntrek



Toepassing

voor achterdeuren, 38 tot 40 mm dik



TYPE 6675-10

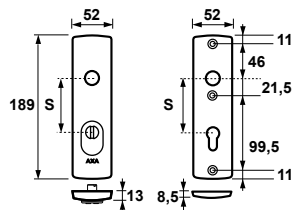

Productpositie

Deur

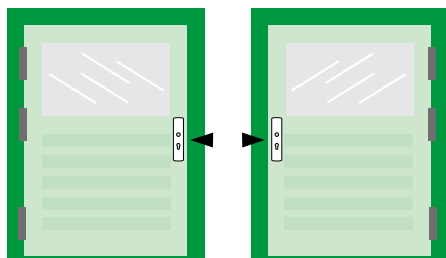

Toepasbare draairichting

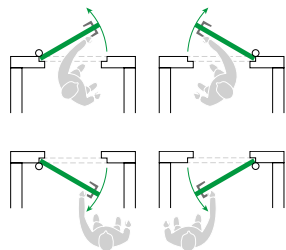

Artikelnummer	Materiaal/kleur/finish	PC	Klein-verpakking	Groot-verpakking	Minimaal bestelaantal	Aanbevolen bevestiging
6675-10-11/55	aluminium geslepen F1	55	1	12	1	M6 x 50 mm
6675-10-11/72	aluminium geslepen F1	72	1	12	1	M6 x 50 mm

Voorboren
ø 8 / 13 mm

CURVE VEILIGHEIDSSCHILDEN comfort anti-kerntrek 6655



Toepassing

voor achterdeuren, 38 tot 40 mm dik



TYPE 6655-10

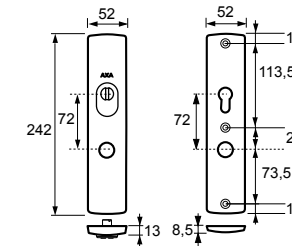

Productpositie

Deur

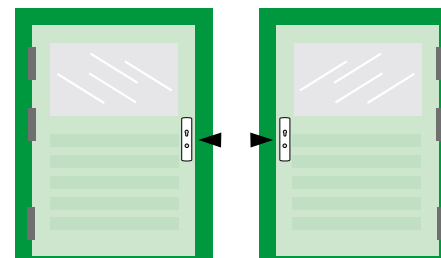

Toepasbare draairichting

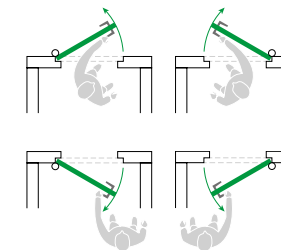

Artikelnummer	Materiaal/kleur/finish	PC	Klein-verpakking	Groot-verpakking	Minimaal bestelaantal	Aanbevolen bevestiging
6655-10-11/72	aluminium geslepen F1	72	1	12	1	M6 x 50 mm

Voorboren
ø 8 / 13 mm

6685 CURVE VEILIGHEIDSROZETTEN anti-kerntrek

Toepassing

voor buitendeuren, 38 tot 40 mm dik



TYPE 6685-00

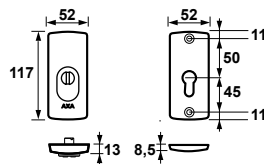

Productpositie

Deur

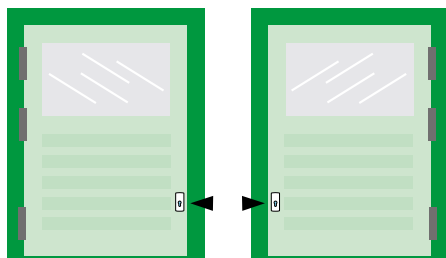

Toepasbare draairichting

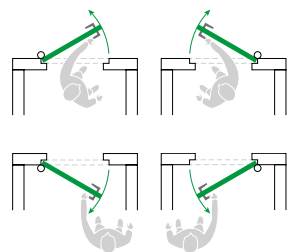

Artikelnummer	Materiaal/kleur/finish	Klein-verpakking	Groot-verpakking	Minimaal bestelaantal	Aanbevolen bevestiging
6685-00-11/E	aluminium geslepen F1	6	60	6	M6 x 50 mm
6685-00-29/E	aluminium geslepen Inox	6	60	6	M6 x 50 mm

Bijzonderheden:
/E = EAN sticker direct op product

Voorboren
ø 8 / 13 mm

CURVE VEILIGHEIDSROZETTEN anti-kerntrek 6685

Toepassing

voor buitendeuren, 38 tot 40 mm dik



TYPE 6685-10

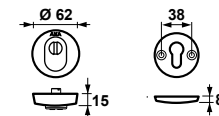

Productpositie

Deur

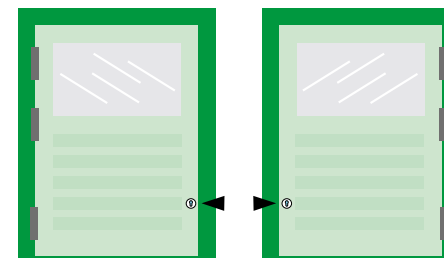

Toepasbare draairichting

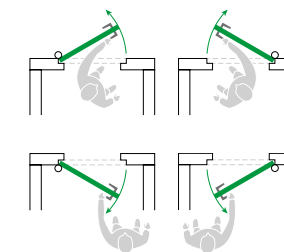

Artikelnummer	Materiaal/kleur/finish	Klein-verpakking	Groot-verpakking	Minimaal bestelaantal	Aanbevolen bevestiging
6685-10-11/E	aluminium geslepen F1	1	10	10	M6 x 50 mm
6685-10-29/E	aluminium geslepen Inox	1	10	10	M6 x 50 mm

Bijzonderheden:
/E = EAN sticker direct op product

Voorboren
ø 8 / 13 mm

6785 CURVE VEILIGHEIDSRUZETTEN smal anti-kerntrek

Toepassing

voor voordeuren, 38 tot 67 mm dik



TYPE 6785-00

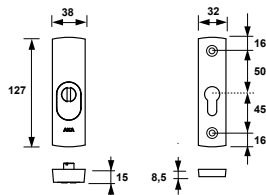

Productpositie

Deur

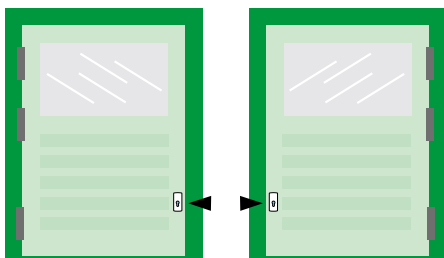

Toepasbare draairichting

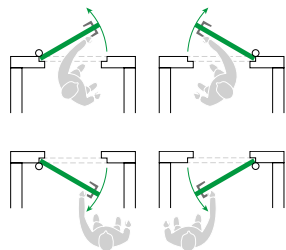

Artikelnummer	Materiaal/kleur/finish	Klein-verpakking	Groot-verpakking	Minimaal bestelaantal	Aanbevolen bevestiging
6785-00-11/E	aluminium geslepen F1	6	60	1	M6 x 50 mm / M6 x 70 mm

Bijzonderheden:
/E = EAN sticker direct op product

Voorboren
ø 8 / 13 mm

CURVE VEILIGHEIDSBESLAG duwer 6660

Toepassing

voor voordeuren, 38 tot 40 mm dik



TYPE 6660-30

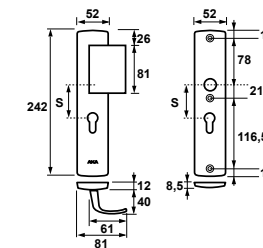

Productpositie

Deur

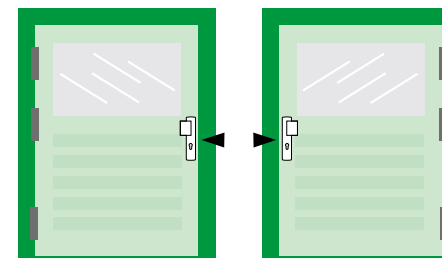

Toepasbare draairichting

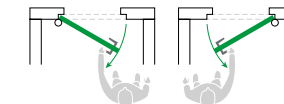

Artikelnummer	Materiaal/kleur/finish	PC	Klein-verpakking	Groot-verpakking	Minimaal bestelaantal	Aanbevolen bevestiging
6660-30-11/55	aluminium geslepen F1	55	1	10	1	M6 x 50 mm
6660-30-11/55/K	aluminium geslepen F1	55	1	10	1	M6 x 50 mm / M6 x 70 mm
6660-30-11/72	aluminium geslepen F1	72	1	10	1	M6 x 50 mm
6660-30-11/72K	aluminium geslepen F1	72	1	10	1	M6 x 50 mm / M6 x 70 mm

Bijzonderheden:
K = inclusief Blokkruk en M6 x70 mm bouten en duwerstift 90 mm voor deurdikte tot 60 mm

Voorboren
ø 8 / 13 mm

6660 CURVE VEILIGHEIDSBESLAG S-knop



Toepassing

voor voordeuren, 38 tot 40 mm dik



TYPE 6660-51

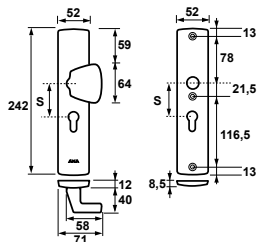

Productpositie

Deur

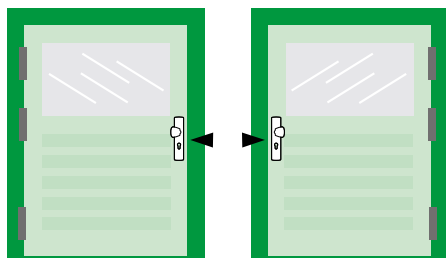

Toepasbare draairichting

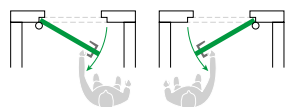

Artikelnummer	Materiaal/kleur/finish	PC	Klein-verpakking	Groot-verpakking	Minimaal bestelaantal	Aanbevolen bevestiging
6660-51-11/55	aluminium geslepen F1	55	1	12	1	M6 x 50 mm
6660-51-11/55K	aluminium geslepen F1	55	1	10	1	M6 x 50 mm / M6 x 70 mm
6660-51-11/72	aluminium geslepen F1	72	1	12	1	M6 x 50 mm
6660-51-11/72K	aluminium geslepen F1	72	1	10	1	M6 x 50 mm / M6 x 70 mm

Bijzonderheden:
K = inclusief Blokkruk en M6 x70 mm bouten en duwerstift 90 mm voor deurdikte tot 60 mm



CURVE VEILIGHEIDSBESLAG kruk 6660



Toepassing

voor achterdeuren, 38 tot 60 mm dik



TYPE 6660-10

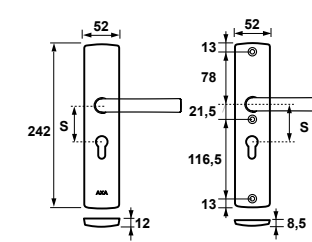

Productpositie

Deur

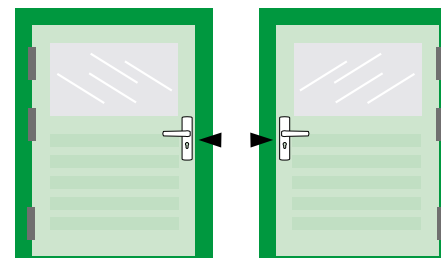

Toepasbare draairichting

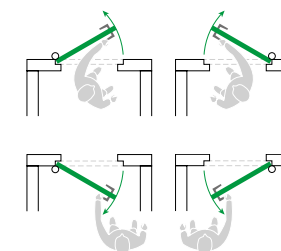

Artikelnummer	Materiaal/kleur/finish	PC	Klein-verpakking	Groot-verpakking	Minimaal bestelaantal	Aanbevolen bevestiging
6660-10-11/55K	aluminium geslepen F1	55	1	10	1	M6 x 50 mm / M6 x 70 mm
6660-10-11/72K	aluminium geslepen F1	72	1	10	1	M6 x 50 mm / M6 x 70 mm

Bijzonderheden:
K = inclusief Blokkruk en M6 x70 mm bouten



6650 CURVE VEILIGHEIDSBESLAG comfort duwer



Toepassing

voor voordeuren, 38 tot 40 mm dik



TYPE 6650-30

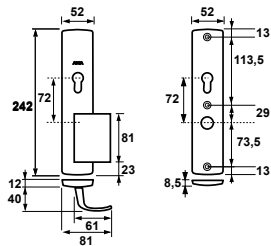

Productpositie

Deur

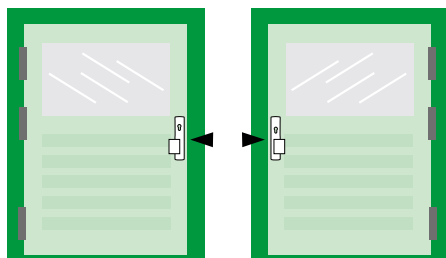

Toepasbare draairichting

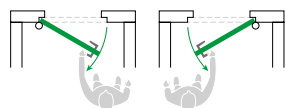

Artikelnummer	Materiaal/kleur/finish	PC	Klein-verpakking	Groot-verpakking	Minimaal bestelaantal	Aanbevolen bevestiging
6650-30-11/72	aluminium geslepen F1	55	1	12	1	M6 x 50 mm

Voorboren
ø 8 / 13 mm

CURVE VEILIGHEIDSBESLAG comfort S-knop 6650



Toepassing

voor voordeuren, 38 tot 40 mm dik



TYPE 6650-42

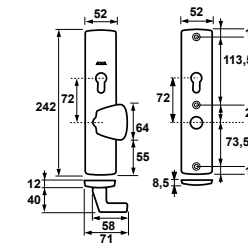

Productpositie

Deur

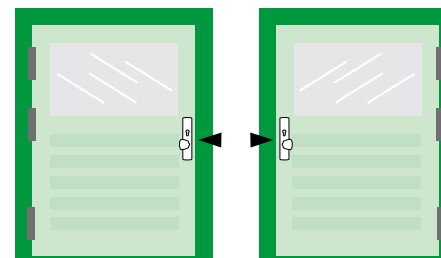

Toepasbare draairichting

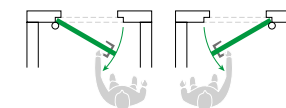

Artikelnummer	Materiaal/kleur/finish	PC	Klein-verpakking	Groot-verpakking	Minimaal bestelaantal	Aanbevolen bevestiging
6650-42-11/72	aluminium geslepen F1	72	1	12	1	M6 x 50 mm

Voorboren
ø 8 / 13 mm

6660 CURVE VEILIGHEIDSSCHILDEN



Toepassing

voor achterdeuren, 38 tot 40 mm dik



TYPE 6660-10

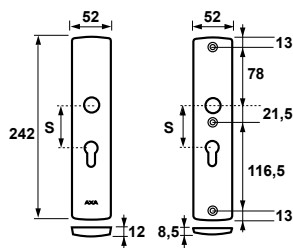

Productpositie

Deur

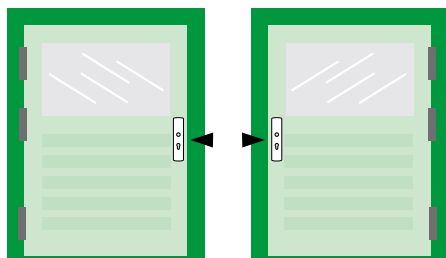

Toepasbare draairichting

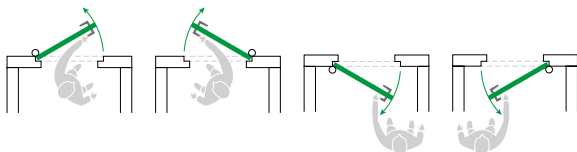

Artikelnummer	Materiaal/kleur/finish	PC	Klein-verpakking	Groot-verpakking	Minimaal bestelaantal	Aanbevolen bevestiging
6660-10-11/55	aluminium geslepen F1	55	1	12	1	M6 x 50 mm
6660-10-11/72	aluminium geslepen F1	72	1	12	1	M6 x 50 mm
6660-10-11/85	aluminium geslepen F1	85	1	12	1	M6 x 50 mm
6660-10-11/92	aluminium geslepen F1	92	1	12	1	M6 x 50 mm

Voorboren
ø 8 / 13 mm

CURVE VEILIGHEIDSSCHILDEN 6660



Toepassing

voor tuin- en balkondeuren, 38 tot 40 mm dik



TYPE 6660-12

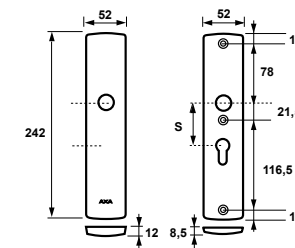

Productpositie

Deur

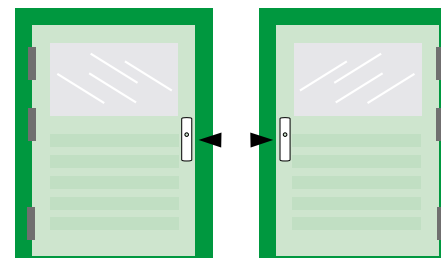

Toepasbare draairichting

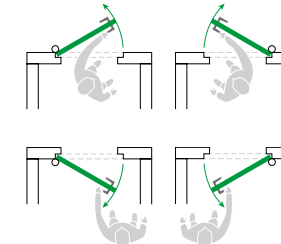

Artikelnummer	Materiaal/kleur/finish	PC	Klein-verpakking	Groot-verpakking	Minimaal bestelaantal	Aanbevolen bevestiging
6660-12-11/55	aluminium geslepen F1	55	1	12	1	M6 x 50 mm
6660-12-11/72	aluminium geslepen F1	72	1	12	1	M6 x 50 mm

Voorboren
ø 8 / 13 mm

6650 CURVE VEILIGHEIDSSCHILDEN comfort



Toepassing

voor buitendeuren, 38 tot 40 mm dik



TYPE 6650-10

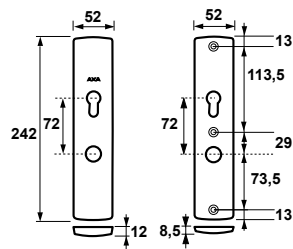

Productpositie

Deur

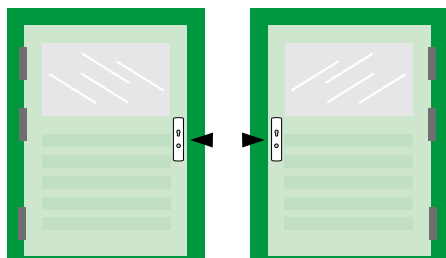

Toepasbare draairichting

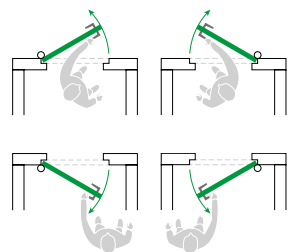

Artikelnummer	Materiaal/kleur/finish	PC	Klein-verpakking	Groot-verpakking	Minimaal bestelaantal	Aanbevolen bevestiging
6650-10-11/72	aluminium geslepen F1	72	1	12	1	M6 x 50 mm

Voorboren
ø 8 / 13 mm

CURVE VEILIGHEIDS BUITENSCHILD 6660



Toepassing

voor buitendeuren, 38 tot 60 mm dik



TYPE 6660-90

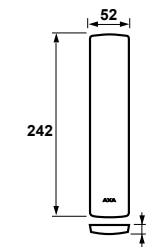

Productpositie

Deur

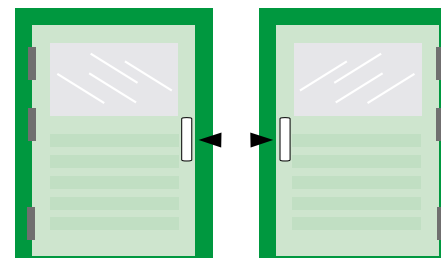

Toepasbare draairichting

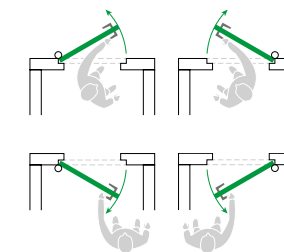

Artikelnummer	Materiaal/kleur/finish	PC	Klein-verpakking	Groot-verpakking	Minimaal bestelaantal	Aanbevolen bevestiging
6660-90-11	aluminium geslepen F1	-	5	10	5	M6 x 50 mm

Voorboren
ø 8 / 13 mm

6660 CURVE VEILIGHEIDS BUITENSCHILD



Toepassing

voor buitendeuren, 38 tot 40 mm dik



TYPE 6660-90

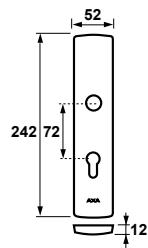

Productpositie

Deur

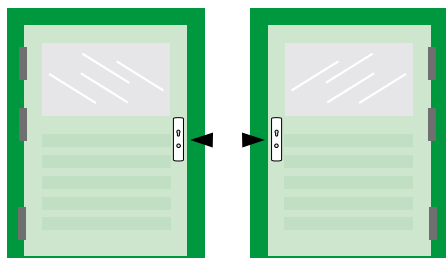

Toepasbare draairichting

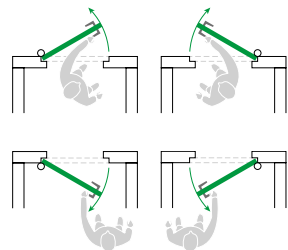

Artikelnummer	Materiaal/kleur/finish	PC	Klein-verpakking	Groot-verpakking	Minimaal bestelaantal	Aanbevolen bevestiging
6660-90-11/72	aluminium geslepen F1	72	5	10	5	M6 x 50 mm

Voorboren
ø 8 / 13 mm

CURVE VEILIGHEIDS BUITENSCHILD 6660



Toepassing

voor buitendeuren, 38 tot 40 mm dik



TYPE 6660-91

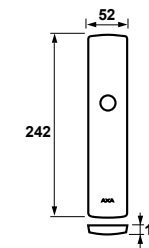

Productpositie

Deur

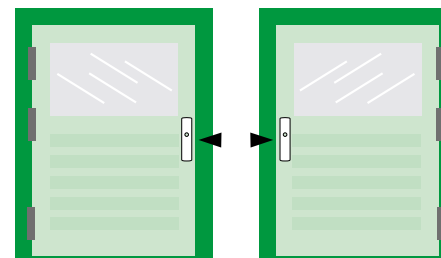

Toepasbare draairichting

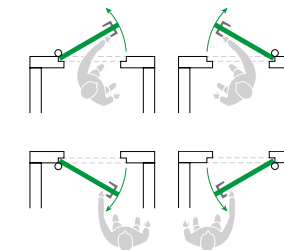

Artikelnummer	Materiaal/kleur/finish	PC	Klein-verpakking	Groot-verpakking	Minimaal bestelaantal	Aanbevolen bevestiging
6660-91-11	aluminium geslepen F1	-	5	10	5	M6 x 50 mm

Voorboren
ø 8 / 13 mm

6660 CURVE VEILIGHEIDS BUITENSCHILD

CURVE VEILIGHEIDS BINNENSCHILD 6661



Toepassing

voor buitendeuren, 38 tot 40 mm dik



TYPE 6660-91

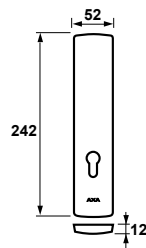

Toepassing

voor buitendeuren, 38 tot 40 mm dik

TYPE 6661-90

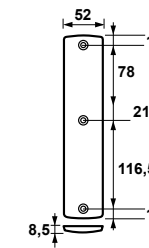

Productpositie

Deur

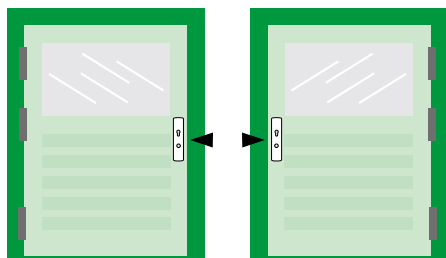

Productpositie

Deur

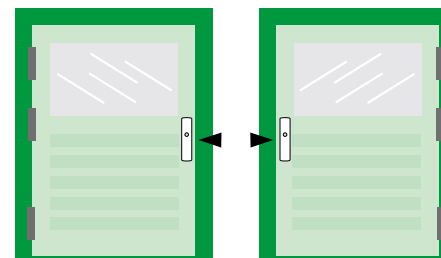

Toepasbare draairichting

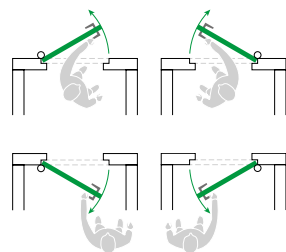

Toepasbare draairichting

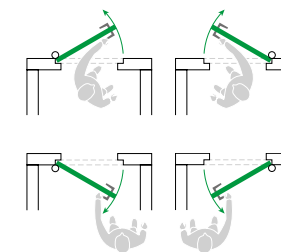

Artikelnummer	Materiaal/kleur/finish	PC	Klein-verpakking	Groot-verpakking	Minimaal bestelaantal	Aanbevolen bevestiging
6660-91-11/72	aluminium geslepen F1	72	5	10	5	M6 x 50 mm

Voorboren
ø 8 / 13 mm

Artikelnummer	Materiaal/kleur/finish	PC	Klein-verpakking	Groot-verpakking	Minimaal bestelaantal	Aanbevolen bevestiging
6661-90-11	aluminium geslepen F1	-	3	36	3	M6 x 50 mm

Voorboren
ø 8 / 13 mm

6661 CURVE VEILIGHEIDS BINNENSCHILD



Toepassing

voor buitendeuren, 38 tot 40 mm dik

TYPE 6661-90

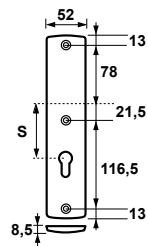

Productpositie

Deur

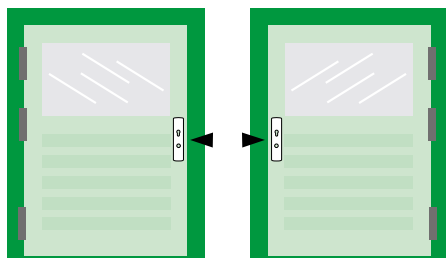

Toepasbare draairichting

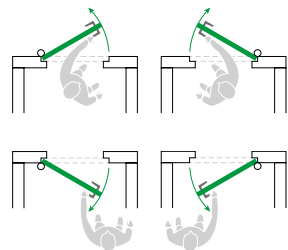

Artikelnummer	Materiaal/kleur/finish	PC	Klein-verpakking	Groot-verpakking	Minimaal bestelaantal	Aanbevolen bevestiging
6661-90-11/55	aluminium geslepen F1	55	3	36	3	M6 x 50 mm
6661-90-11/72	aluminium geslepen F1	72	3	36	3	M6 x 50 mm

Voorboren
ø 8 / 13 mm

CURVE VEILIGHEIDS BINNENSCHILD 6661



Toepassing

voor buitendeuren, 38 tot 40 mm dik

TYPE 6661-91

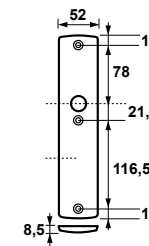

Productpositie

Deur

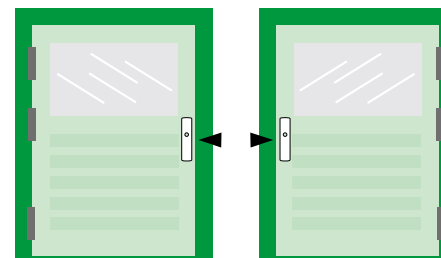

Toepasbare draairichting

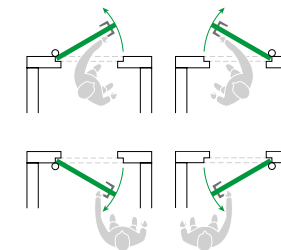

Artikelnummer	Materiaal/kleur/finish	PC	Klein-verpakking	Groot-verpakking	Minimaal bestelaantal	Aanbevolen bevestiging
6661-91-11	aluminium geslepen F1	-	3	36	3	M6 x 50 mm

Voorboren
ø 8 / 13 mm

6670 CURVE VEILIGHEIDSSCHILDEN kort



Toepassing

voor buitendeuren, 38 tot 40 mm dik



TYPE 6670-10

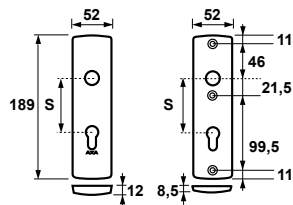

Productpositie

Deur

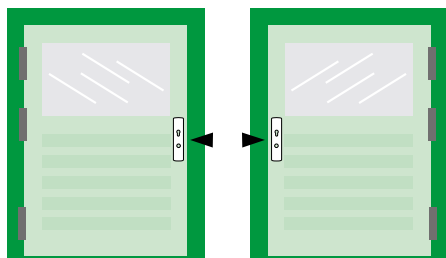

Toepasbare draairichting

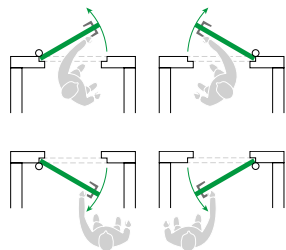

Artikelnummer	Materiaal/kleur/finish	PC	Klein-verpakking	Groot-verpakking	Minimaal bestelaantal	Aanbevolen bevestiging
6670-10-11/55	aluminium geslepen F1	55	1	12	1	M6 x 50 mm
6670-10-11/72	aluminium geslepen F1	72	1	12	1	M6 x 50 mm

Voorboren
ø 8 / 13 mm

CURVE VEILIGHEIDSSCHILDEN 6680



Toepassing

voor buitendeuren, 38 tot 40 mm dik



TYPE 6680-00

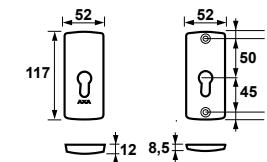

Productpositie

Deur

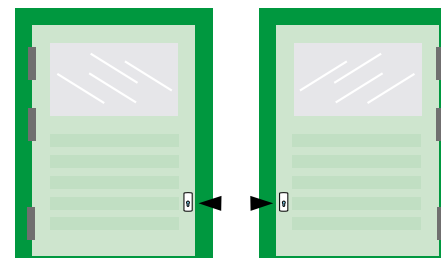

Toepasbare draairichting

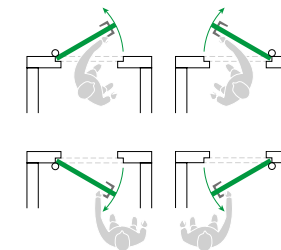

Artikelnummer	Materiaal/kleur/finish	Klein-verpakking	Groot-verpakking	Minimaal bestelaantal	Aanbevolen bevestiging
6680-00-11	aluminium geslepen F1	2	24	2	M6 x 50 mm

Voorboren
ø 8 / 13 mm

6680 CURVE VEILIGHEIDSRUZETTEN

Toepassing

voor buitendeuren, 38 tot 40 mm dik



TYPE 6680-10

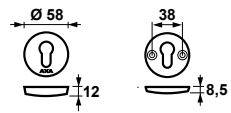

Productpositie

Deur

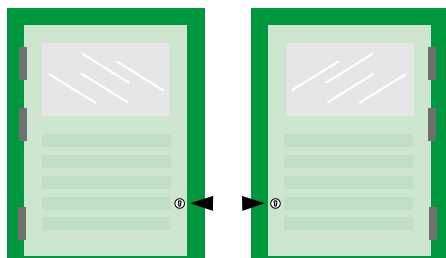

Toepasbare draairichting

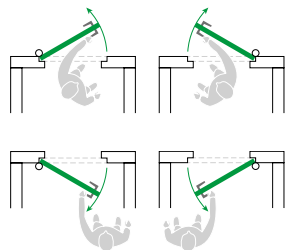

Artikelnummer	Materiaal/kleur/finish	Klein-verpakking	Groot-verpakking	Minimaal bestelaantal	Aanbevolen bevestiging
6680-10-11	aluminium geslepen F1	2	24	2	M6 x 50 mm

Voorboren
ø 8 / 13 mm

DEURKRUK L 6140

Toepassing

voor buiten- en binnendeuren, 38 tot 60 mm dik



TYPE 6140

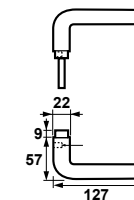

Productpositie

Deur

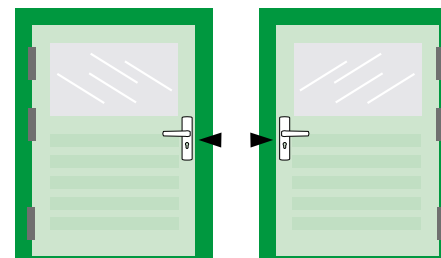

Toepasbare draairichting

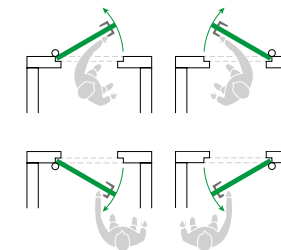

Artikelnummer	Materiaal/kleur/finish	Klein-verpakking	Groot-verpakking	Minimaal bestelaantal	Aanbevolen bevestiging
6140-71-11/E	aluminium geslepen F1	6	36	6	madeschroef M6
6140-80-11	aluminium geslepen F1 (gatdeel)	6	60	6	madeschroef M6

Bijzonderheden:
/E = EAN sticker direct op product

6141 DEURKROK U



Toepassing

voor buiten- en binnendeuren,
38 tot 60 mm dik

TYPE 6141

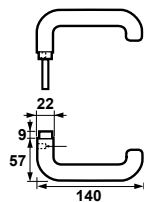

Productpositie

Deur

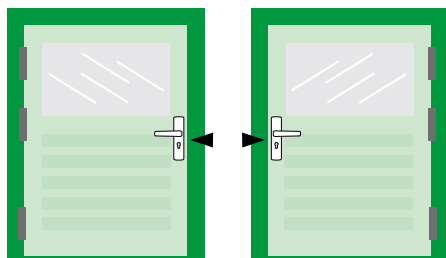

Toepasbare draairichting

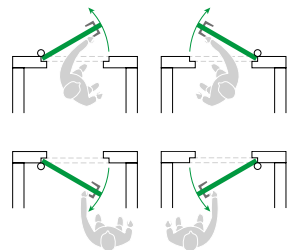

Artikelnummer	Materiaal/kleur/finish	Klein-verpakking	Groot-verpakking	Minimaal bestelaantal	Aanbevolen bevestiging
6141-71-11/E	aluminium geslepen F1	6	36	6	madeschroef M6
6141-71-91	aluminium geanodiseerd F1	6	36	6	madeschroef M6
6141-80-11	aluminium geslepen F1 (gatdeel)	6	60	6	madeschroef M6

Bijzonderheden:
/E = EAN sticker direct op product

DEURKROK C 6142



Toepassing

voor buiten- en binnendeuren,
38 tot 60 mm dik

TYPE 6142

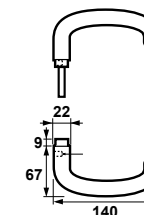

Productpositie

Deur

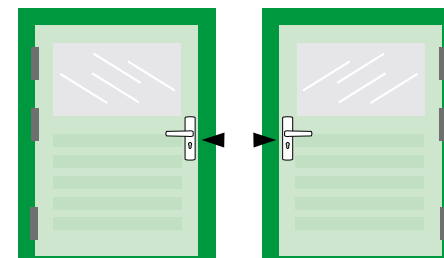

Toepasbare draairichting

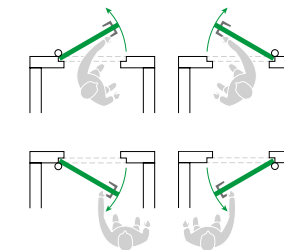

Artikelnummer	Materiaal/kleur/finish	Klein-verpakking	Groot-verpakking	Minimaal bestelaantal	Aanbevolen bevestiging
6142-71-11/E	aluminium geslepen F1	6	36	6	madeschroef M6
6142-80-11	aluminium geslepen F1 (gatdeel)	6	60	6	madeschroef M6

Bijzonderheden:
/E = EAN sticker direct op product

6150 DEURKROK CURVE



Toepassing

voor buiten- en binnendeuren,
38 tot 60 mm dik

TYPE 6150

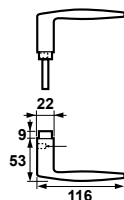

Productpositie

Deur

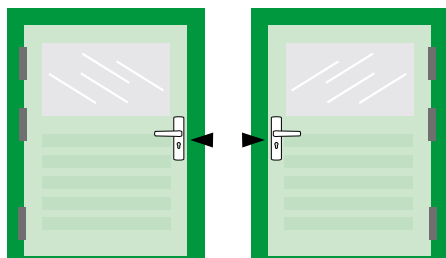

Toepasbare draairichting

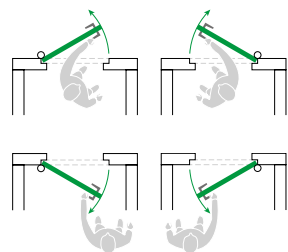

Artikelnummer	Materiaal/kleur/finish	Klein-verpakking	Groot-verpakking	Minimaal bestelaantal	Aanbevolen bevestiging
6150-71-11/E	aluminium geslepen F1	6	36	6	madeschroef M6
6150-71-91	aluminium geanodiseerd F1	6	36	6	madeschroef M6
6150-80-11	aluminium geslepen F1 (gatdeel)	6	60	6	madeschroef M6

Bijzonderheden:
/E = EAN sticker direct op product

DEURKROK BLOK ZWAAR 6164



Toepassing

voor buiten- en binnendeuren,
38 tot 60 mm dik

TYPE 6164

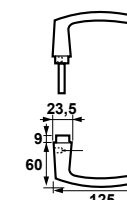

Productpositie

Deur

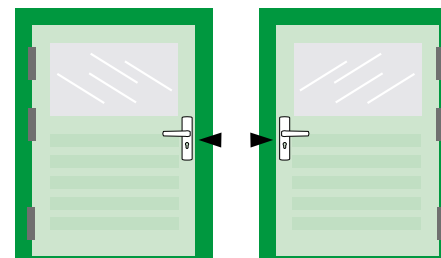

Toepasbare draairichting

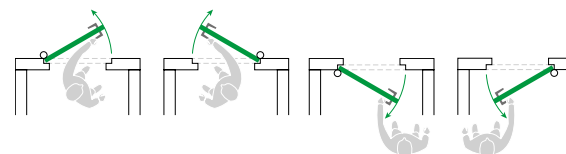

Artikelnummer	Materiaal/kleur/finish	Klein-verpakking	Groot-verpakking	Minimaal bestelaantal	Aanbevolen bevestiging
6164-71-11/E	aluminium geslepen F1	6	36	6	madeschroef M6
6164-71-91/E	aluminium geanodiseerd F1	6	36	6	madeschroef M6
6164-71-92/E	aluminium geanodiseerd F2	6	36	6	madeschroef M6
6164-72-11*	aluminium geslepen F1	6	36	6	madeschroef M6
6164-80-11	aluminium geslepen F1 (gatdeel)	6	60	6	madeschroef M6

Bijzonderheden:
/E = EAN sticker direct op product | * = geklonken, speciaal voor deuren tussen 54 en 60 mm

6171 DEURKROK SABEL



Toepassing

voor buiten- en binnendeuren,
38 tot 60 mm dik

TYPE 6171

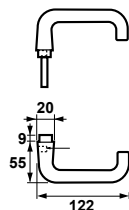

Productpositie

Deur

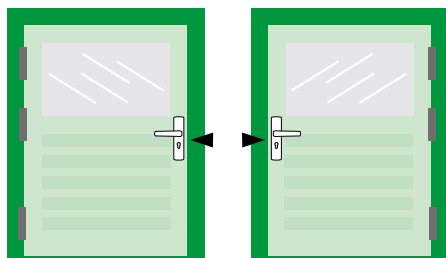

Toepasbare draairichting

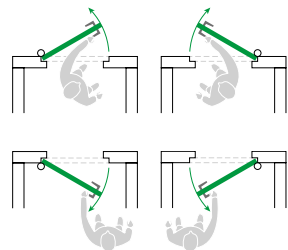

Artikelnummer	Materiaal/kleur/finish	Klein-verpakking	Groot-verpakking	Minimaal bestelaantal	Aanbevolen bevestiging
6171-71-11	aluminium geslepen F1	6	36	6	madeschroef M6
6171-71-91/E	aluminium geanodiseerd F1	6	36	6	madeschroef M6

Bijzonderheden:
/E = EAN sticker direct op product

DEURKROK S-KNOP 6841



Toepassing

voor buiten- en binnendeuren,
38 tot 60 mm dik

TYPE 6164

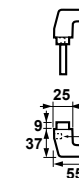

Productpositie

Deur

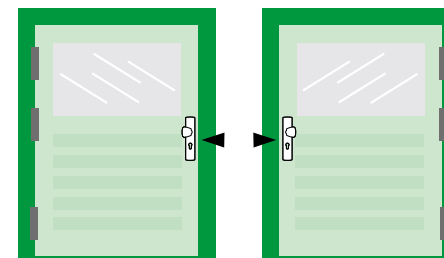

Toepasbare draairichting

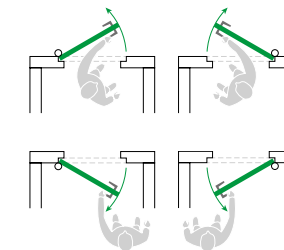

Artikelnummer	Materiaal/kleur/finish	Klein-verpakking	Groot-verpakking	Minimaal bestelaantal	Aanbevolen bevestiging
6841-11-11/E	aluminium geslepen F1	6	36	6	madeschroef M6

Bijzonderheden:
/E = EAN sticker direct op product

6154 DEURKROK BLOK



Toepassing

voor binnendeuren,
38 tot 40 mm dik

TYPE 6154

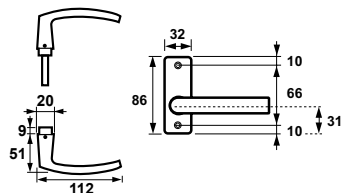

Productpositie

Deur

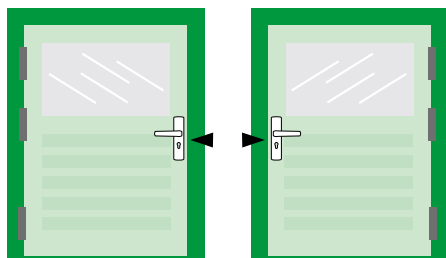

Toepasbare draairichting

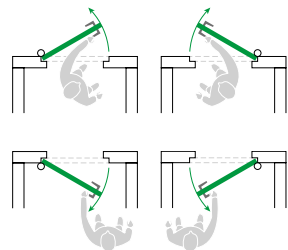

Artikelnummer	Materiaal/kleur/finish	Klein-verpakking	Groot-verpakking	Minimaal bestelaantal	Aanbevolen bevestiging
6154-10-91/E	aluminium geanodiseerd F1	10	60	10	stiftpen
6154-10-92/E	aluminium geanodiseerd F2	10	60	10	stiftpen
6154-30-92*	aluminium geanodiseerd F2	10	60	10	stiftpen, patentbout+bus M4

Bijzonderheden:
/E = EAN sticker direct op product | * = inclusief rozetten

DEURKROK VLINDER 6155



Toepassing

voor binnendeuren,
38 tot 40 mm dik

TYPE 6155

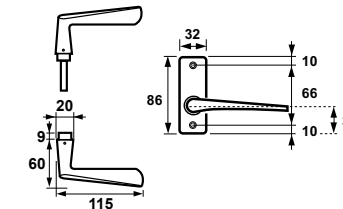

Productpositie

Deur

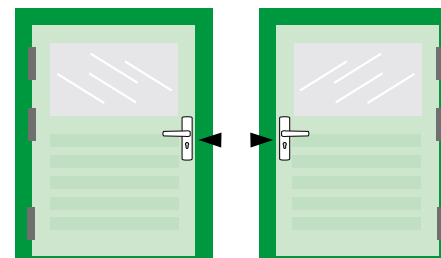

Toepasbare draairichting

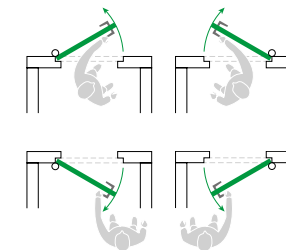

Artikelnummer	Materiaal/kleur/finish	Klein-verpakking	Groot-verpakking	Minimaal bestelaantal	Aanbevolen bevestiging
6155-07-91/E	aluminium geanodiseerd F1	10	60	10	stiftpen
6155-07-92/E	aluminium geanodiseerd F2	10	60	10	stiftpen
6155-27-92*	aluminium geanodiseerd F2	10	60	10	stiftpen, patentbout+bus M4

Bijzonderheden:
/E = EAN sticker direct op product | * = inclusief rozetten

6170 DEURKROK DUIM

DEURKROK SABEL 6171



Toepassing

Voor binnendeuren,
38 tot 40 mm dik

TYPE 6170

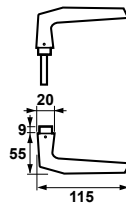

Toepassing

Voor binnendeuren,
38 tot 40 mm dik

TYPE 6171

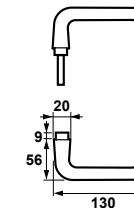

Productpositie

Deur

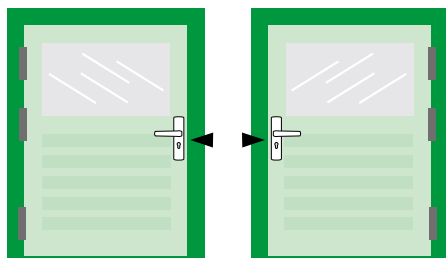

Productpositie

Deur

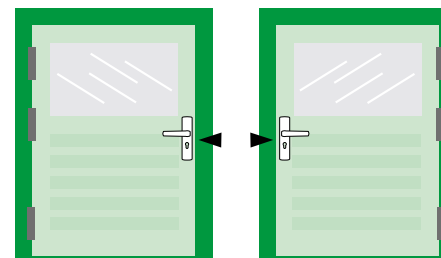

Toepasbare draairichting

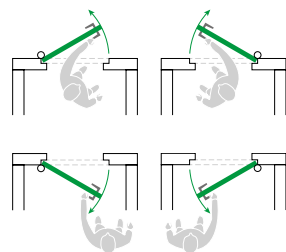

Toepasbare draairichting

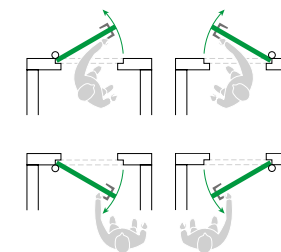

Artikelnummer	Materiaal/kleur/finish	Klein-verpakking	Groot-verpakking	Minimaal bestelaantal	Aanbevolen bevestiging
6170-10-91/E	aluminium geanodiseerd F1	10	60	10	stiftpen
6170-10-92/E	aluminium geanodiseerd F2	10	60	10	stiftpen

Bijzonderheden:
/E = EAN sticker direct op product

Artikelnummer	Materiaal/kleur/finish	Klein-verpakking	Groot-verpakking	Minimaal bestelaantal	Aanbevolen bevestiging
6171-10-92/E	aluminium geanodiseerd F1	10	60	10	stiftpen

Bijzonderheden:
/E = EAN sticker direct op product

6210 CURVE KLIK PC BINNENDEURSCHILDEN



Toepassing
voor binnendeuren

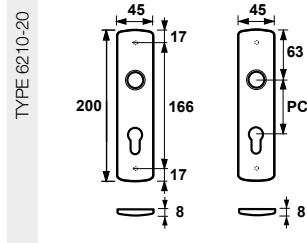

Productpositie

Deur

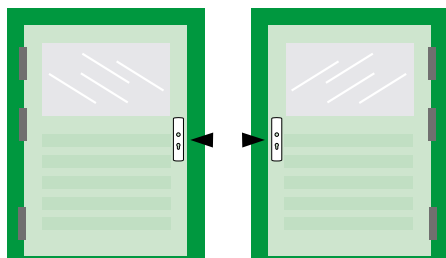

Toepasbare draairichting

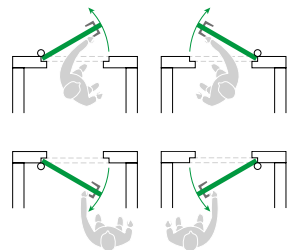

Artikelnummer	Materiaal/kleur/finish	PC	Klein-verpakking	Groot-verpakking	Minimaal bestelaantal	Aanbevolen bevestiging
6210-20-11/55E	aluminium geslepen F1	55	-	15	15	4,0 x 20 mm
6210-20-11/72E	aluminium geslepen F1	72	-	15	15	4,0 x 20 mm

Bijzonderheden:
/E = EAN sticker direct op product

Voorboren
ø 2,0 mm

CURVE KLIK SL BINNENDEURSCHILDEN 6210



Toepassing
voor binnendeuren

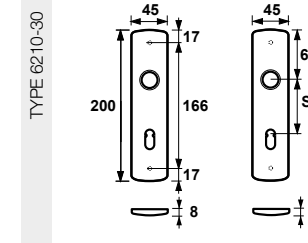

Productpositie

Deur

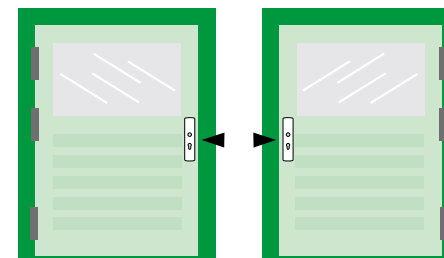

Toepasbare draairichting

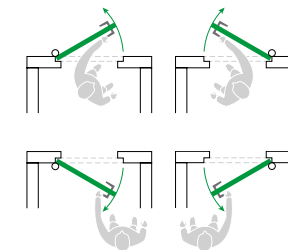

Artikelnummer	Materiaal/kleur/finish	SL	Klein-verpakking	Groot-verpakking	Minimaal bestelaantal	Aanbevolen bevestiging
6210-30-11/56E	aluminium geslepen F1	55	-	15	15	4,0 x 20 mm
6210-30-11/72E	aluminium geslepen F1	72	-	15	15	4,0 x 20 mm

Bijzonderheden:
/E = EAN sticker direct op product

Voorboren
ø 2,0 mm

6210 CURVE KLIK TOILETDEURSCHILDEN

CURVE KLIK LOOPDEURSCHILDEN 6210



Toepassing
voor binnendeuren

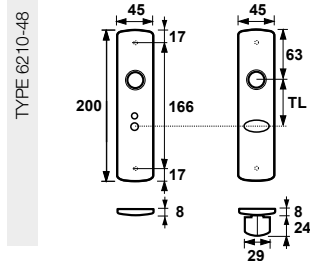

Toepassing
voor binnendeuren

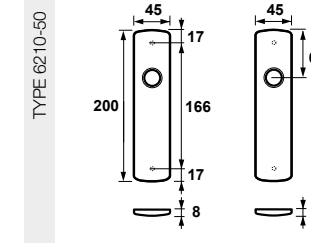

Productpositie

Deur

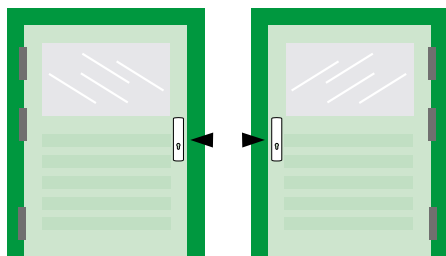

Productpositie

Deur

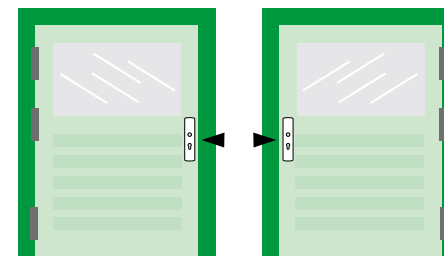

Toepasbare draairichting

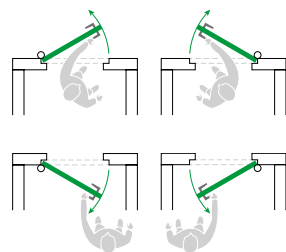

Toepasbare draairichting

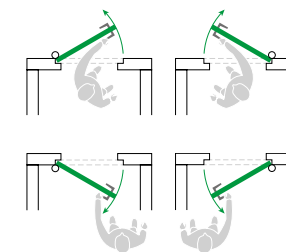

Artikelnummer	Materiaal/kleur/finish	TL	Klein-verpakking	Groot-verpakking	Minimaal bestelaantal	Aanbevolen bevestiging
6210-48-11/63E	aluminium geslepen F1	63	-	15	15	4,0 x 20 mm
6210-48-11/72E	aluminium geslepen F1	72	-	15	15	4,0 x 20 mm

Bijzonderheden:
/E = EAN sticker direct op product

Voorboren
ø 2,0 mm

Artikelnummer	Materiaal/kleur/finish	Klein-verpakking	Groot-verpakking	Minimaal bestelaantal	Aanbevolen bevestiging
6210-50-11/E	aluminium geslepen F1	-	15	15	4,0 x 20 mm

Bijzonderheden:
/E = EAN sticker direct op product

Voorboren
ø 2,0 mm

6210 CURVE KLIK KASTDEURSCHILDEN



Toepassing
voor binnendeuren

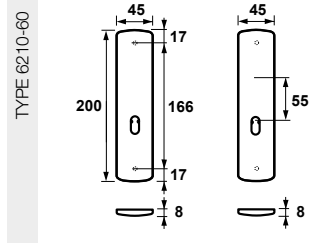

Productpositie

Deur

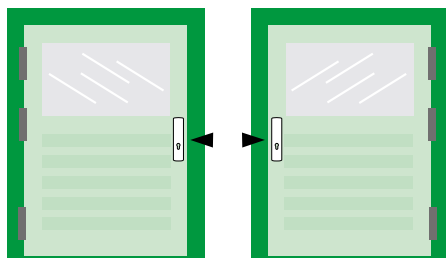

Toepasbare draairichting

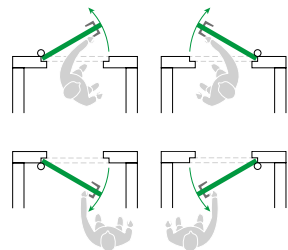

Artikelnummer	Materiaal/kleur/finish	SL	Klein-verpakking	Groot-verpakking	Minimaal bestelaantal	Aanbevolen bevestiging
6210-60-11/E	aluminium geslepen F1	55	-	12	12	4,0 x 20 mm

Bijzonderheden:
/E = EAN sticker direct op product

Voorboren
ø 2,0 mm

CURVE KLIK KASTDEURSCHILD 6210



Toepassing
voor binnendeuren

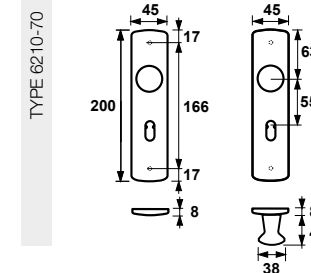

Productpositie

Deur

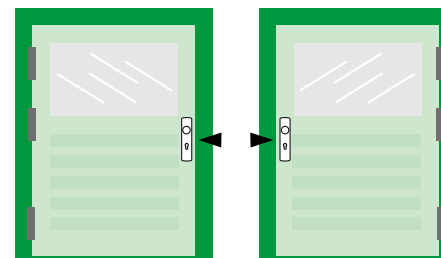

Toepasbare draairichting

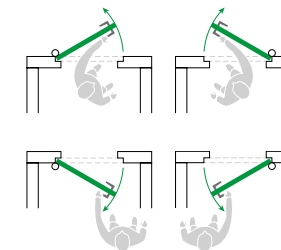

Artikelnummer	Materiaal/kleur/finish	SL	Klein-verpakking	Groot-verpakking	Minimaal bestelaantal	Aanbevolen bevestiging
6210-70-11/56E	aluminium geslepen F1	55	-	12	12	4,0 x 20 mm

Bijzonderheden:
/E = EAN sticker direct op product

Voorboren
ø 2,0 mm

6210 CURVE KLIK BINNENDEURROZETTEN

CURVE KLIK BINNENDEURROZETTEN 6220

Toepassing

voor binnendeuren



TYPE 6210-90

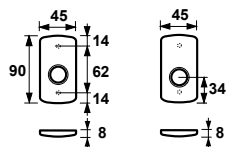

Toepassing

voor binnendeuren



TYPE 6220-10

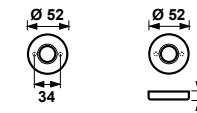

Productpositie

Deur

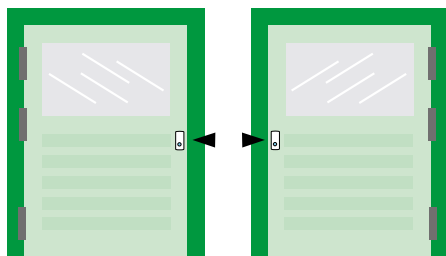

Productpositie

Deur

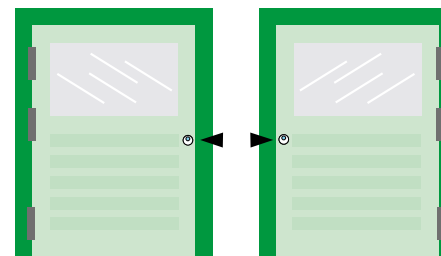

Toepasbare draairichting

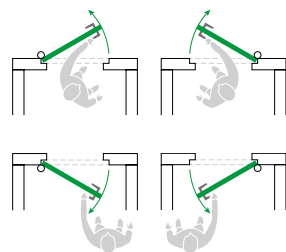

Toepasbare draairichting

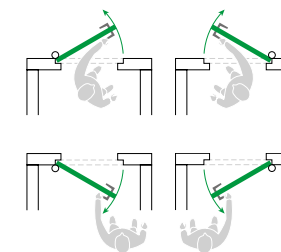

Artikelnummer	Materiaal/kleur/finish	Klein-verpakking	Groot-verpakking	Minimaal bestelaantal	Aanbevolen bevestiging
6210-90-11/E	aluminium geslepen F1	12	24	12	4,0 x 20 mm

Bijzonderheden:
/E = EAN sticker direct op product

Voorboren
ø 2,0 mm

Artikelnummer	Materiaal/kleur/finish	Klein-verpakking	Groot-verpakking	Minimaal bestelaantal	Aanbevolen bevestiging
6220-10-11/E	aluminium geslepen F1	-	10	10	4,0 x 20 mm

Bijzonderheden:
/E = EAN sticker direct op product

Voorboren
ø 2,0 mm

6220 CURVE KLIK SL BINNENDEURROZETTEN



Toepassing

voor binnendeuren

TYPE 6220-20

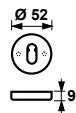

Productpositie

Deur

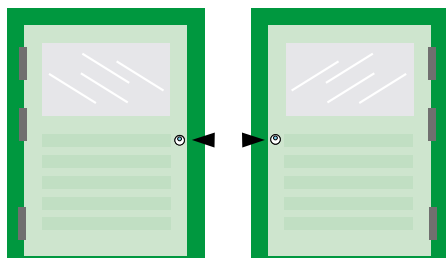

Toepasbare draairichting

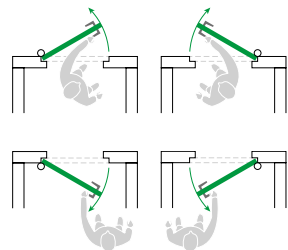

Artikelnummer	Materiaal/kleur/finish	Klein-verpakking	Groot-verpakking	Minimaal bestelaantal	Aanbevolen bevestiging
6220-20-11/E	aluminium geslepen F1	-	10	10	4,0 x 20 mm

Bijzonderheden:
/E = EAN sticker direct op product

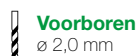

CURVE KLIK PC BINNENDEURROZETTEN 6220



Toepassing

voor binnendeuren

TYPE 6220-30

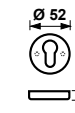

Productpositie

Deur

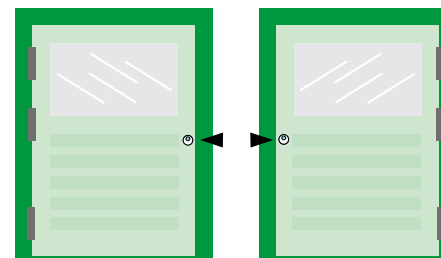

Toepasbare draairichting

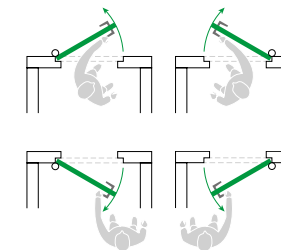

Artikelnummer	Materiaal/kleur/finish	Klein-verpakking	Groot-verpakking	Minimaal bestelaantal	Aanbevolen bevestiging
6220-30-11/E	aluminium geslepen F1	-	10	10	4,0 x 20 mm

Bijzonderheden:
/E = EAN sticker direct op product



6220 CURVE KLIK TOILETDEURROZETTEN

Toepassing

voor binnendeuren



TYPE 6220-40

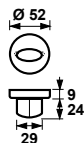

Productpositie

Deur

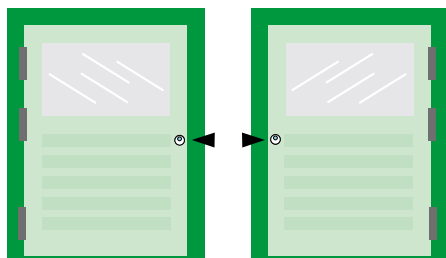

Toepasbare draairichting

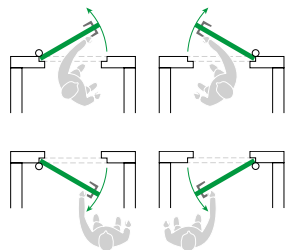

Artikelnummer	Materiaal/kleur/finish	Klein-verpakking	Groot-verpakking	Minimaal bestelaantal	Aanbevolen bevestiging
6220-40-11/E	aluminium geslepen F1	-	10	10	4,0 x 20 mm

Bijzonderheden:
/E = EAN sticker direct op product

Voorboren
ø 2,0 mm

CURVE BINNENDEURSCHILDEN

6350

Toepassing

voor binnendeuren



TYPE 6350-20

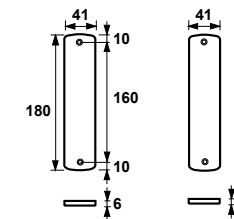

Productpositie

Deur

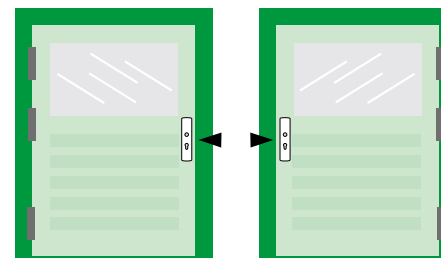

Toepasbare draairichting

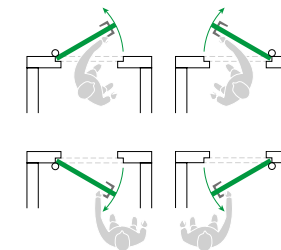

Artikelnummer	Materiaal/kleur/finish	Klein-verpakking	Groot-verpakking	Minimaal bestelaantal	Aanbevolen bevestiging
6350-20-91/E	aluminium geanodiseerd F1	10	40	10	patentbout+bus M4

Bijzonderheden:
/E = EAN sticker direct op product

Voorboren
ø 5,0 mm

6350 CURVE PC BINNENDEURSCHILDEN

CURVE SL BINNENDEURSCHILDEN 6350



Toepassing
voor binnendeuren

TYPE 6350-20

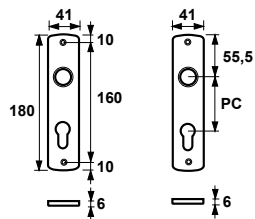

Toepassing
voor binnendeuren

TYPE 6350-30

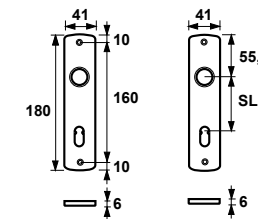

Productpositie

Deur

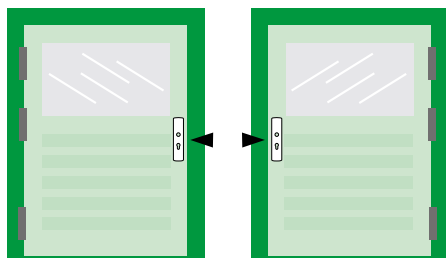

Productpositie

Deur

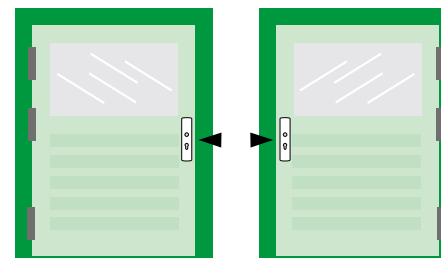

Toepasbare draairichting

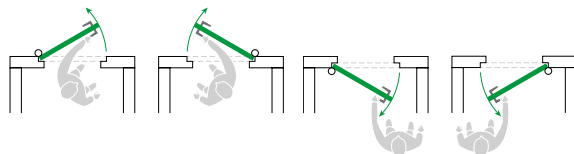

Toepasbare draairichting

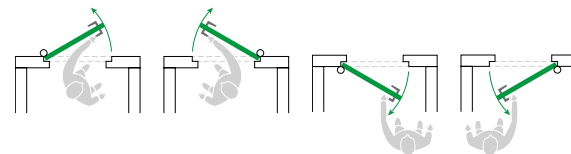

Artikelnummer	Materiaal/kleur/finish	PC	Klein-verpakking	Groot-verpakking	Minimaal bestelaantal	Aanbevolen bevestiging
6350-20-91/55E	aluminium geanodiseerd F1	55	10	40	10	patentbout+bus M4
6350-20-91/72E	aluminium geanodiseerd F1	72	10	40	10	patentbout+bus M4
6350-20-92/55E	aluminium geanodiseerd F2	55	10	40	10	patentbout+bus M4
6350-20-92/72E	aluminium geanodiseerd F2	72	10	40	10	patentbout+bus M4

Bijzonderheden:
/E = EAN sticker direct op product

Voorboren
ø 5,0 mm

Artikelnummer	Materiaal/kleur/finish	SL	Klein-verpakking	Groot-verpakking	Minimaal bestelaantal	Aanbevolen bevestiging
6350-30-91/56E	aluminium geanodiseerd F1	55	10	40	10	patentbout+bus M4
6350-30-91/72E	aluminium geanodiseerd F1	72	10	40	10	patentbout+bus M4
6350-30-92/56E	aluminium geanodiseerd F2	55	10	40	10	patentbout+bus M4
6350-30-92/72E	aluminium geanodiseerd F2	72	10	40	10	patentbout+bus M4

Bijzonderheden:
/E = EAN sticker direct op product

Voorboren
ø 5,0 mm

6350 CURVE TOILETDEURSCHILDEN



Toepassing
voor binnendeuren

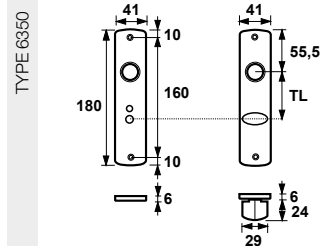

Productpositie

Deur

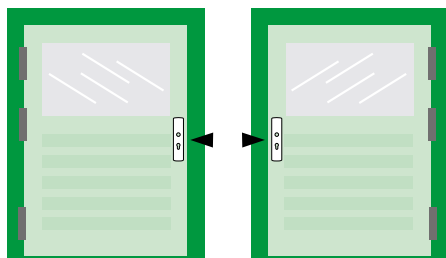

Toepasbare draairichting

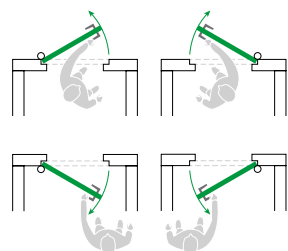

Artikelnummer	Materiaal/kleur/finish	TL	Klein-verpakking	Groot-verpakking	Minimaal bestelaantal	Aanbevolen bevestiging
6350-45-91/57E	aluminium geanodiseerd F1	57	6	24	6	patentbout+bus M4
6350-48-91/55E	aluminium geanodiseerd F1	55	6	24	6	patentbout+bus M4
6350-48-91/63E	aluminium geanodiseerd F1	63	6	24	6	patentbout+bus M4
6350-48-91/72E	aluminium geanodiseerd F1	72	6	24	6	patentbout+bus M4
6350-45-92/57E	aluminium geanodiseerd F2	57	6	24	6	patentbout+bus M4
6350-48-92/55E	aluminium geanodiseerd F2	55	6	24	6	patentbout+bus M4
6350-48-92/63E	aluminium geanodiseerd F2	63	6	24	6	patentbout+bus M4

Bijzonderheden:
/E = EAN sticker direct op product

Voorboren
ø 5,0 mm

CURVE LOOPDEURSCHILDEN 6350



Toepassing
voor binnendeuren

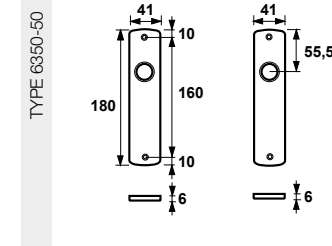

Productpositie

Deur

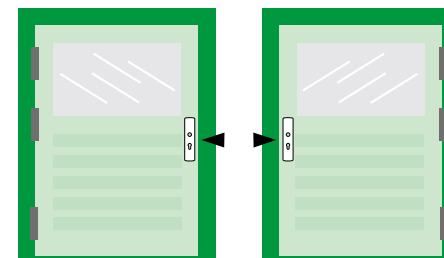

Toepasbare draairichting

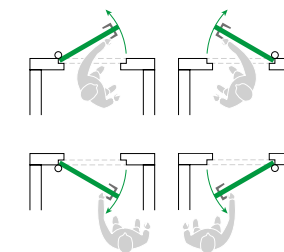

Artikelnummer	Materiaal/kleur/finish	Klein-verpakking	Groot-verpakking	Minimaal bestelaantal	Aanbevolen bevestiging
6350-50-91/E	aluminium geanodiseerd F1	10	10	40	patentbout+bus M4
6350-50-92/E	aluminium geanodiseerd F2	10	10	40	patentbout+bus M4

Bijzonderheden:
/E = EAN sticker direct op product

Voorboren
ø 5,0 mm

6350 CURVE KASTDEURSCHILDEN



Toepassing
voor binnendeuren

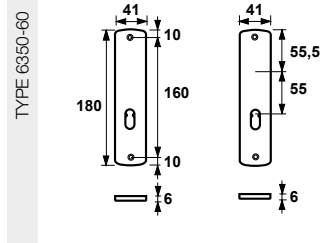

Productpositie

Deur

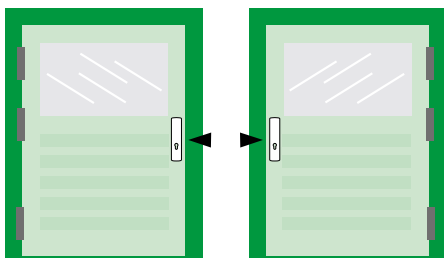

Toepasbare draairichting

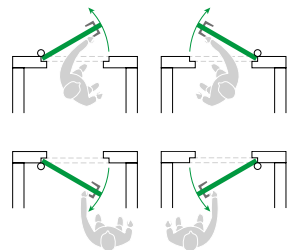

Artikelnummer	Materiaal/kleur/finish	SL	Klein-verpakking	Groot-verpakking	Minimaal bestelaantal	Aanbevolen bevestiging
6350-60-91/E	aluminium geanodiseerd F1	55	10	10	40	patentbout+bus M4

Bijzonderheden:
/E = EAN sticker direct op product

Voorboren
ø 5,0 mm

CURVE KASTDEURSCHILD 6350



Toepassing
voor binnendeuren

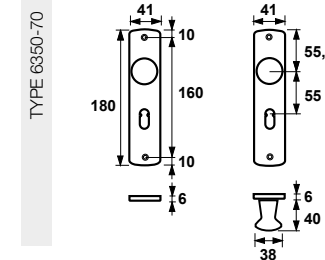

Productpositie

Deur

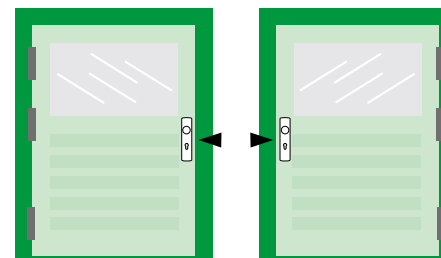

Toepasbare draairichting

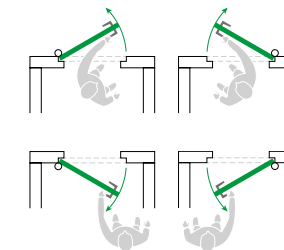

Artikelnummer	Materiaal/kleur/finish	SL	Klein-verpakking	Groot-verpakking	Minimaal bestelaantal	Aanbevolen bevestiging
6350-70-91/56E	aluminium geanodiseerd F1	55	6	24	6	patentbout+bus M4
6350-70-92/56E	aluminium geanodiseerd F2	55	6	24	6	patentbout+bus M4

Bijzonderheden:
/E = EAN sticker direct op product

Voorboren
ø 5,0 mm

6350 CURVE BINNENDEURROZETTEN

Toepassing

voor binnendeuren



TYPE 6350-90

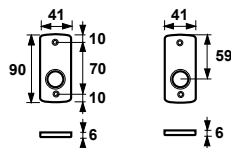

Productpositie

Deur

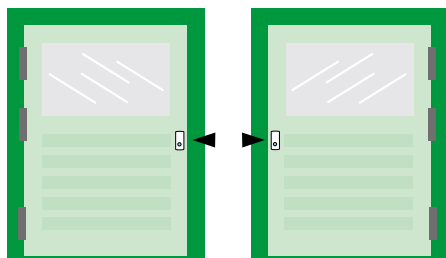

Toepasbare draairichting

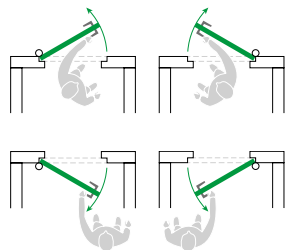

Artikelnummer	Materiaal/kleur/finish	Klein-verpakking	Groot-verpakking	Minimaal bestelaantal	Aanbevolen bevestiging
6350-90-91/E	aluminium geanodiseerd F1	10	40	10	patentbout+bus M4
6350-90-92/E	aluminium geanodiseerd F2	10	40	10	patentbout+bus M4

Bijzonderheden:
/E = EAN sticker direct op product

Voorboren
ø 5,0 mm

CURVE SL BINNENDEURROZETTEN 6350

Toepassing

voor binnendeuren



TYPE 6350-91

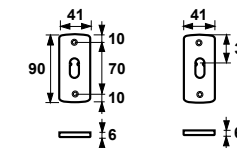

Productpositie

Deur

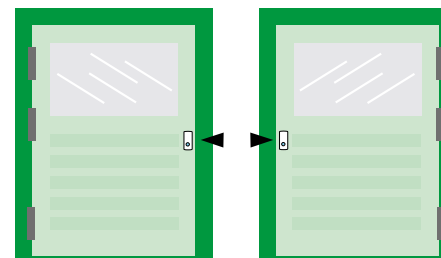

Toepasbare draairichting

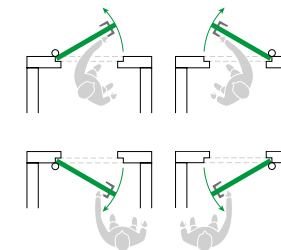

Artikelnummer	Materiaal/kleur/finish	Klein-verpakking	Groot-verpakking	Minimaal bestelaantal	Aanbevolen bevestiging
6350-91-91/E	aluminium geanodiseerd F1	10	40	10	patentbout+bus M4
6350-91-92/E	aluminium geanodiseerd F2	10	40	10	patentbout+bus M4

Bijzonderheden:
/E = EAN sticker direct op product

Voorboren
ø 5,0 mm

6350 CURVE PC BINNENDEURROZETTEN

Toepassing

voor binnendeuren



TYPE 6350-92

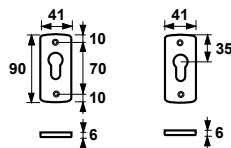

Productpositie

Deur

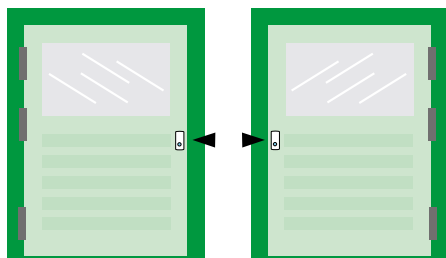

Toepasbare draairichting

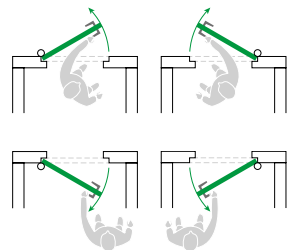

Artikelnummer	Materiaal/kleur/finish	Klein-verpakking	Groot-verpakking	Minimaal bestelaantal	Aanbevolen bevestiging
6350-92-91/E	aluminium geanodiseerd F1	10	40	10	patentbout+bus M4

Bijzonderheden:
/E = EAN sticker direct op product

Voorboren
ø 5,0 mm

BRIEFPLAAT CURVE 6201

Toepassing

voor buitendeuren



TYPE 6201

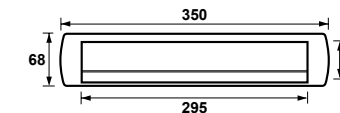

Artikelnummer	Materiaal/kleur/finish	Klein-verpakking	Groot-verpakking	Minimaal bestelaantal	Aanbevolen bevestiging
6201-00-11/E	aluminium geslepen F1	/	10	10	M5 x 50 mm

Bijzonderheden:
/E = EAN sticker direct op product

Voorboren
ø 8,0 mm

BRIEFPLAAT 6205

Toepassing

voor buitendeuren



TYPE 6205

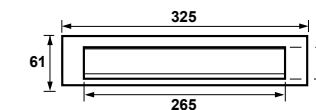

Artikelnummer	Materiaal/kleur/finish	Klein-verpakking	Groot-verpakking	Minimaal bestelaantal	Aanbevolen bevestiging
6205-33-11/E	aluminium geslepen Inox	/	30	30	4,0 x 20
6205-33-29/E	aluminium geslepen Inox	/	30	30	4,0 x 20
6205-33-91	aluminium geanodiseerd F1	/	30	30	4,0 x 20
6205-33-92-E	aluminium geanodiseerd F2	/	30	30	4,0 x 20

Bijzonderheden:
/E = EAN sticker direct op product

Voorboren
ø 2,0 mm

6206 BRIEFPLAAT MET NAAMPLAAT

Toepassing

voor buitendeuren



TYPE 6206

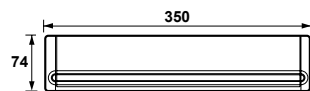

Artikelnummer	Materiaal/kleur/finish	Klein-verpakking	Groot-verpakking	Minimaal bestelaantal	Aanbevolen bevestiging
6206-00-11/E	aluminium geslepen F1	/	10	10	3,0 x 20 mm
6206-00-92/E	aluminium geslepen F2	/	10	10	3,0 x 20 mm

Bijzonderheden:
/E = EAN sticker direct op product

Vorboren
ø 1,5 mm

DEURKNOP PADDESTOEL 6251

Toepassing

voor deuren



TYPE 6251

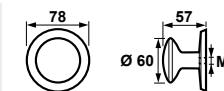

Artikelnummer	Materiaal/kleur/finish	Klein-verpakking	Groot-verpakking	Minimaal bestelaantal	Aanbevolen bevestiging
6251-07-11/E	aluminium geslepen F2	4	24	4	draadeind+moer M8

Bijzonderheden:
/E = EAN sticker direct op product

Vorboren
ø 8,0 mm

DEURKNOP SCHAAL 6253

Toepassing

voor deuren



TYPE 6201

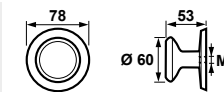

Artikelnummer	Materiaal/kleur/finish	Klein-verpakking	Groot-verpakking	Minimaal bestelaantal	Aanbevolen bevestiging
6253-07-92	aluminium geanodiseerd F2	12	72	12	draadeind+moer M8

Vorboren
ø 8,0 mm

ONDERDELEN EN ACCESSOIRES DEURBESLAG

Stiftpen
voor deurkrukken

TYPE 6051-80

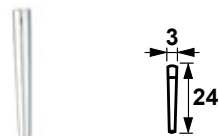

Patentbout

TYPE 6051-92

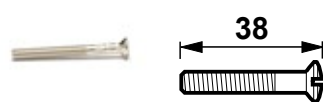

Stelstiftbout
voor deurkrukken

TYPE 6051-85



Bus
voor patentbout

TYPE 6051-84



Rood/wit toiletindicator

TYPE 6426-82



Patentbout en bus

TYPE 6051-95



Artikelnummer	Materiaal/kleur/finish	Klein-verpakking	Groot-verpakking	Minimaal bestelaantal	Aanbevolen bevestiging
6051-80-22	galvanisch verzinkt staal	100	1000	100	-
6051-84-08	messing vernikkeld	100	1000	100	-
6051-85-22	galvanisch verzinkt staal	10	100	10	-
6051-92-37	staal vernikkeld	10	100	10	-
6051-95-37	staal vernikkeld	10	100	10	-

ONDERDELEN EN ACCESSOIRES DEURBESLAG

Krukstift

TYPE 6143-60

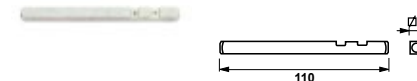

Deurkruklager
voor vlakke deurschilden

TYPE 6051-86



Krukstift

TYPE 6143-61



Deurkruklager
voor Curve deurschilden

TYPE 6600-31



Krukstift

TYPE 6143-62

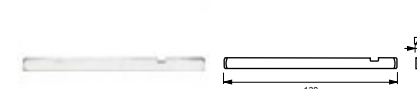

Madeschroef
voor deurkrukken

TYPE 6143-60



Artikelnummer	Materiaal/kleur/finish	Klein-verpakking	Groot-verpakking	Minimaal bestelaantal	Aanbevolen bevestiging
6143-60-23	staal Topcoat gegalvaniseerd	-	500	1	-
6143-61-23	staal Topcoat gegalvaniseerd	-	10	1	-
6143-62-23	staal Topcoat gegalvaniseerd	-	10	1	-
6051-86-95	kunststof wit	-	100	100	-
6600-31-95	kunststof wit	100	500	100	-
6143-60-37	staal vernikkeld	-	500	1	-

ONDERDELEN EN ACCESSOIRES DEURBESLAG

TYPE 6990-68

Verlengde montagebouten veiligheidsbeslag
voor veiligheidsbeslag



TYPE 6990-69

Verlengde montagebouten veiligheidsbeslag met wisselstift
voor Duwer veiligheidsbeslag

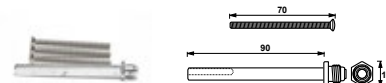

TYPE 6990-66

Standaard montagebouten veiligheidsbeslag
voor veiligheidsbeslag



TYPE 6051-87

Wisselstift deurkruk
deurkruk vervalt voor halve deurkruk



Artikelnummer	Materiaal/kleur/finish	Klein-verpakking	Groot-verpakking	Minimaal bestelaantal	Aanbevolen bevestiging
6990-58-81	RVS	1	100	10	-
6990-66-81	RVS	-	100	10	-
6990-59-23	RVS / galvanisch verzinkt staal	-1	50	1	-
6051-87-22/E	galvanisch verzinkt staal	10	100	10	-

Bijzonderheden:
/E = EAN sticker direct op product

Deursloten

Inhoudsopgave

Pagina

Binnendeur insteeksloten	274
Sluitplaten voor binnendeur insteeksloten	280
Veiligheids insteeksloten	281
Veiligheids sluitkommen voor insteeksloten	290
Sluitplaten voor veiligheids insteeksloten	291
Oplegdeursloten	294
Veiligheids penbijzetsloten	298



7115 KASTSLOT SL



Toepassing
voor binnendeuren

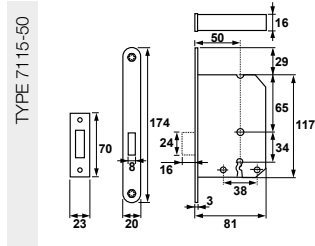

Productpositie

Deur

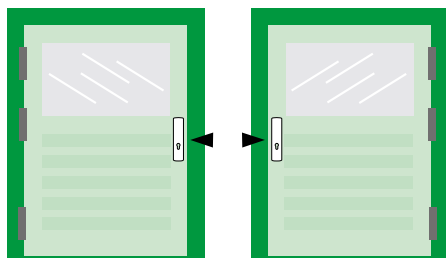

Toepasbare draairichting

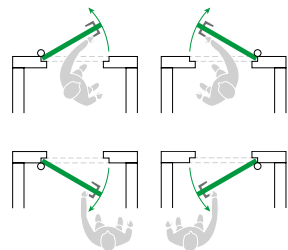

Artikelnummer	Materiaal/kleur/finish	SL	Klein-verpakking	Groot-verpakking	Minimaal bestelaantal	Aanbevolen bevestiging
7115-50-54/55E	voorplaat staal wit	55	5	20	50	4,0 x 20 mm
7115-50-81/55E	voorplaat RVS	55	5	20	50	4,0 x 20 mm

Bijzonderheden:
/E = EAN sticker direct op product

Voorboren
ø 2,0 mm

KASTSLOT PC 7125



Toepassing
voor binnendeuren

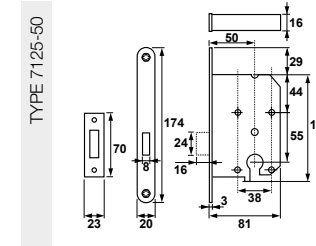

Productpositie

Deur

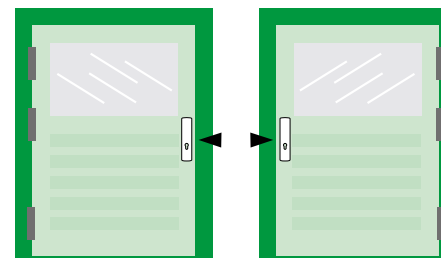

Toepasbare draairichting

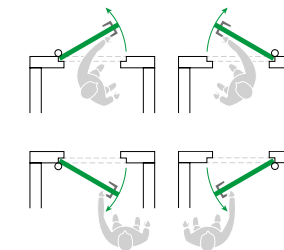

Artikelnummer	Materiaal/kleur/finish	PC	Klein-verpakking	Groot-verpakking	Minimaal bestelaantal	Aanbevolen bevestiging
7125-50-54/55E	voorplaat staal wit	55	5	20	50	4,0 x 20 mm
7125-50-81/55E	voorplaat RVS	55	5	20	50	4,0 x 20 mm

Bijzonderheden:
/E = EAN sticker direct op product

Voorboren
ø 2,0 mm

7135 DAG-NACHTSLOT SL



Toepassing
voor binnendeuren

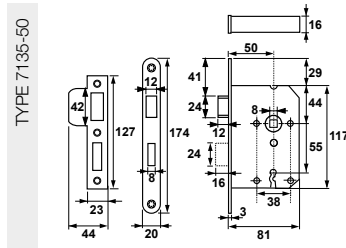

Productpositie

Deur

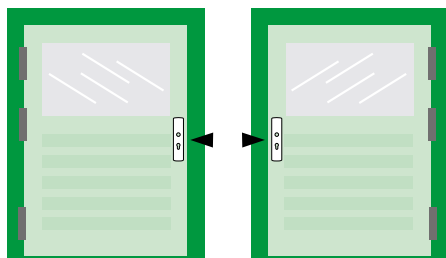

Toepasbare draairichting

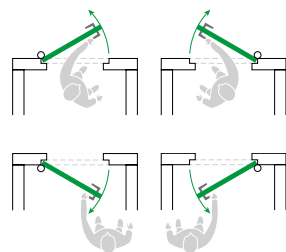

Artikelnummer	Materiaal/kleur/finish	SL	Klein-verpakking	Groot-verpakking	Minimaal bestelaantal	Aanbevolen bevestiging
7135-50-54/55E	voorplaat staal wit	55	5	20	50	4,0 x 20 mm
7135-50-81/55E	voorplaat RVS	55	5	20	50	4,0 x 20 mm

Bijzonderheden:
/E = EAN sticker direct op product

Voorboren
ø 2,0 mm

DAG-NACHTSLOT PC 7145



Toepassing
voor binnendeuren

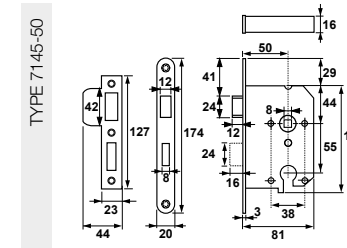

Productpositie

Deur

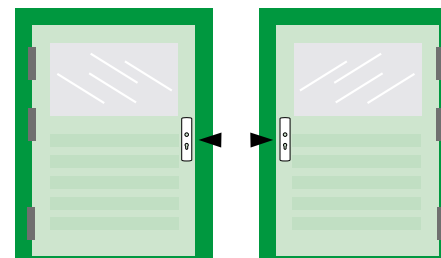

Toepasbare draairichting

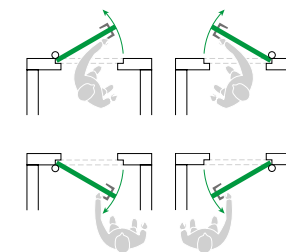

Artikelnummer	Materiaal/kleur/finish	PC	Klein-verpakking	Groot-verpakking	Minimaal bestelaantal	Aanbevolen bevestiging
7145-50-54/55E	voorplaat staal wit	55	5	20	50	4,0 x 20 mm
7145-50-81/55E	voorplaat RVS	55	5	20	50	4,0 x 20 mm

Bijzonderheden:
/E = EAN sticker direct op product

Voorboren
ø 2,0 mm

7155 LOOPSLOT



Toepassing
voor binnendeuren

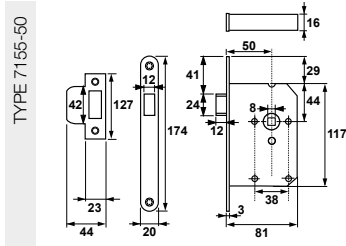

Productpositie

Deur

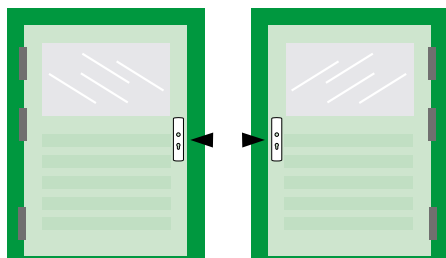

Toepasbare draairichting

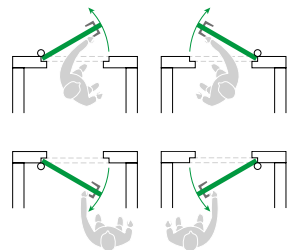

Artikelnummer	Materiaal/kleur/finish	Klein-verpakking	Groot-verpakking	Minimaal bestelaantal	Aanbevolen bevestiging
7155-50-54/E	voorplaat staal wit	5	20	50	4,0 x 20 mm
7155-50-81/E	voorplaat RVS	5	20	50	4,0 x 20 mm

Bijzonderheden:
/E = EAN sticker direct op product

Voorboren
ø 2,0 mm

TOILETSLOT 7165



Toepassing
voor binnendeuren

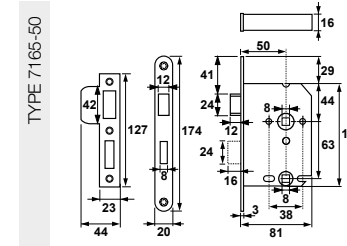

Productpositie

Deur

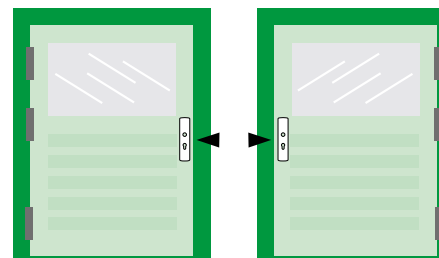

Toepasbare draairichting

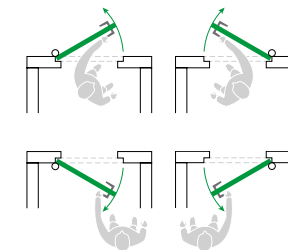

Artikelnummer	Materiaal/kleur/finish	TL	Klein-verpakking	Groot-verpakking	Minimaal bestelaantal	Aanbevolen bevestiging
7165-50-54/55E	voorplaat staal wit	63/8	5	20	50	4,0 x 20 mm
7165-50-81/55E	voorplaat RVS	63/8	5	20	50	4,0 x 20 mm

Bijzonderheden:
/E = EAN sticker direct op product

Voorboren
ø 2,0 mm

SLUITPLATEN VOOR BINNENDEURSLOTEN

Sluitplaat
voor kastslot



TYPE 7110-10



Sluitplaat
voor dag-nachtslot



TYPE 7130-10

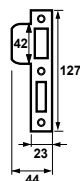

Sluitplaat
voor loopslot



TYPE 7150-10

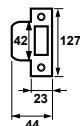

Artikelnummer	Materiaal/kleur/finish	Klein-verpakking	Groot-verpakking	Minimaal bestelaantal	Aanbevolen bevestiging
7110-10-22/E	staal galvanisch verzinkt	10	300	10	3.0 x 20 mm
7110-10-81/E	RVS	10	300	10	3.0 x 20 mm
7130-10-22/E	staal galvanisch verzinkt	10	150	10	3.0 x 20 mm
7130-10-81/E	RVS	10	150	10	3.0 x 20 mm
7150-10-22/E	staal galvanisch verzinkt	10	300	10	3.0 x 20 mm
7150-10-81/E	RVS	10	300	10	3.0 x 20 mm

Bijzonderheden:
/E = EAN sticker direct op product

Voorboren
ø 2,0 mm

VEILIGHEIDS INSTEELK DAG-NACHTSLOT

7415

Toepassing
voor buitendeuren



TYPE 7415-50

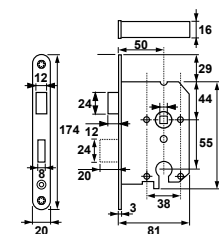

Productpositie
Deur

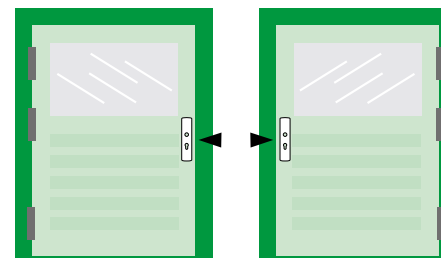

Toepasbare draairichting

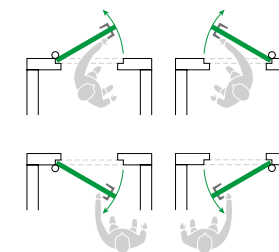

Artikelnummer	Materiaal/kleur/finish	PC	Klein-verpakking	Groot-verpakking	Minimaal bestelaantal	Aanbevolen bevestiging
7415-50-81/55E	voorplaat RVS	55	5	20	5	4.0 x 40 mm

Bijzonderheden:
/E = EAN sticker direct op product

Voorboren
ø 2,0 mm

7420 VEILIGHEIDS INSTEELK DAG-NACHTSLOT



Toepassing
voor buitendeuren

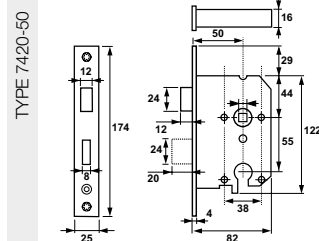

Productpositie

Deur

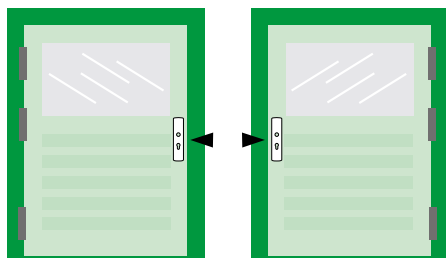

Toepasbare draairichting

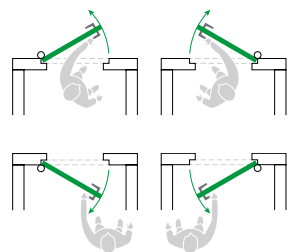

Artikelnummer	Materiaal/kleur/finish	PC	Klein-verpakking	Groot-verpakking	Minimaal bestelaantal	Aanbevolen bevestiging
7420-50-81/55E	voorplaat RVS	55	5	20	5	4.0 x 40 mm

Bijzonderheden:
/E = EAN sticker direct op product



VEILIGHEIDS INSTEELK DAG-NACHTSLOT 7420



Toepassing
voor buitendeuren

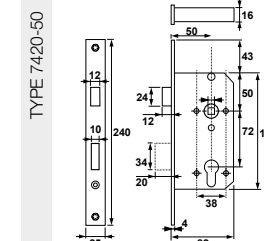

Productpositie

Deur

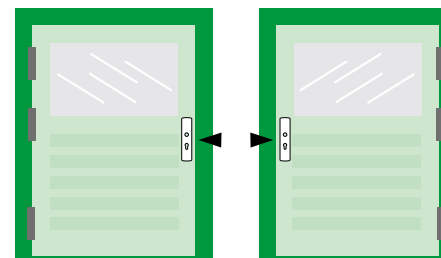

Toepasbare draairichting

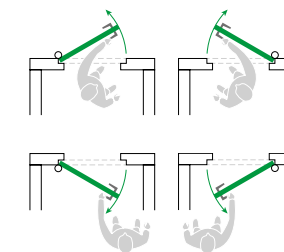

Artikelnummer	Materiaal/kleur/finish	PC	Klein-verpakking	Groot-verpakking	Minimaal bestelaantal	Aanbevolen bevestiging
7420-50-81/72E	voorplaat RVS	72	5	20	5	4.0 x 40 mm

Bijzonderheden:
/E = EAN sticker direct op product



7421 VEILIGHEIDS INSTEELK DAG-NACHTSLOT



Toepassing
voor buitendeuren



TYPE 7421-50

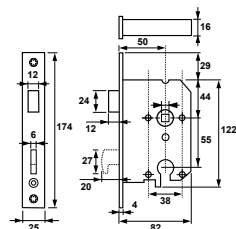

Productpositie

Deur

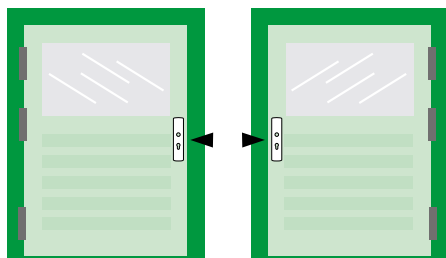

Toepasbare draairichting

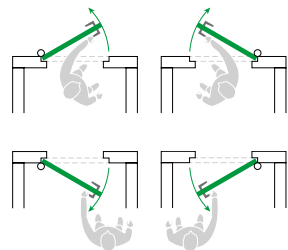

Artikelnummer	Materiaal/kleur/finish	PC	Klein-verpakking	Groot-verpakking	Minimaal bestelaantal	Aanbevolen bevestiging
7421-50-81/55E	voorplaat RVS	55	5	20	5	4.0 x 40 mm

Bijzonderheden:
/E = EAN sticker direct op product



VEILIGHEIDS INSTEELK DAG-NACHTSLOT 7425



Toepassing
voor buitendeuren



TYPE 7425-50

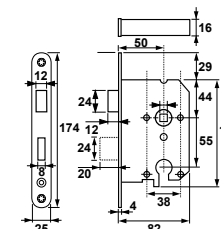

Productpositie

Deur

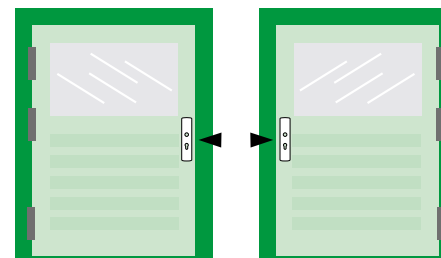

Toepasbare draairichting

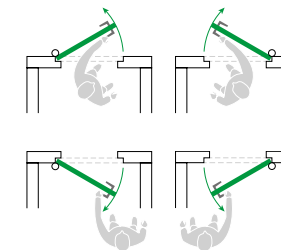

Artikelnummer	Materiaal/kleur/finish	PC	Klein-verpakking	Groot-verpakking	Minimaal bestelaantal	Aanbevolen bevestiging
7425-50-81/55E	voorplaat RVS	55	5	20	5	4.0 x 40 mm

Bijzonderheden:
/E = EAN sticker direct op product



7425 VEILIGHEIDS INSTEELK DAG-NACHTSLOT



Toepassing
voor buitendeuren

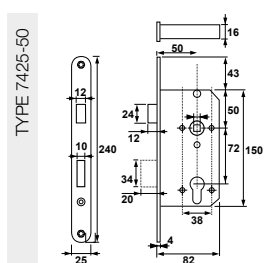

Productpositie

Deur

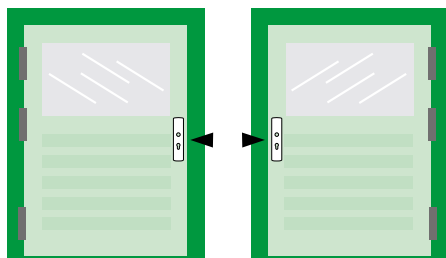

Toepasbare draairichting

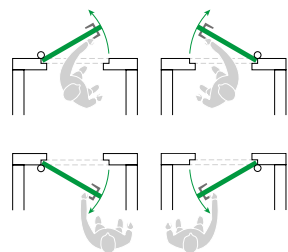

Artikelnummer	Materiaal/kleur/finish	PC	Klein-verpakking	Groot-verpakking	Minimaal bestelaantal	Aanbevolen bevestiging
7425-50-81/72E	voorplaat RVS	72	5	20	5	4.0 x 40 mm

Bijzonderheden:
/E = EAN sticker direct op product



VEILIGHEIDS INSTEELK DAG-NACHTSLOT 7426



Toepassing
voor buitendeuren

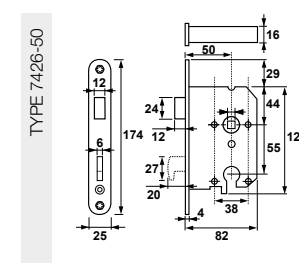

Productpositie

Deur

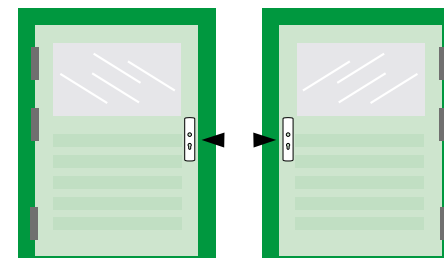

Toepasbare draairichting

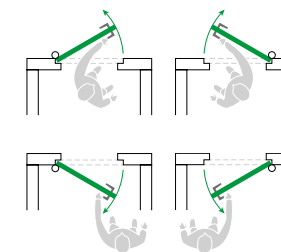

Artikelnummer	Materiaal/kleur/finish	PC	Klein-verpakking	Groot-verpakking	Minimaal bestelaantal	Aanbevolen bevestiging
7426-50-81/55E	voorplaat RVS	55	5	20	5	4.0 x 40 mm

Bijzonderheden:
/E = EAN sticker direct op product



7480 VEILIGHEIDS BIJZETSLOT

VEILIGHEIDS BIJZETSLOT 7485

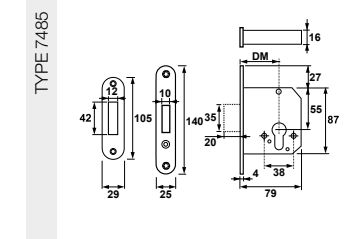
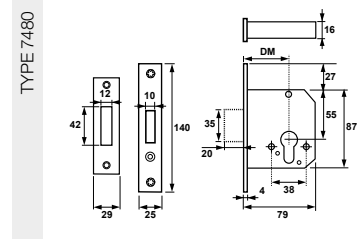

Productpositie

Deur

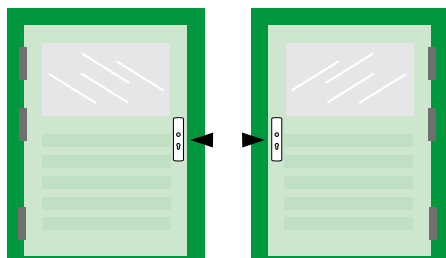

Productpositie

Deur

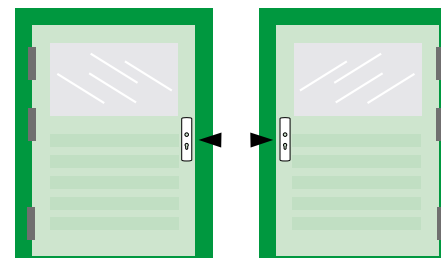

Toepasbare draairichting

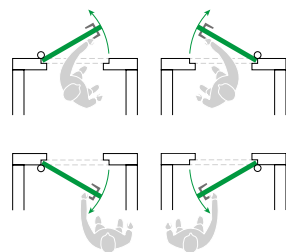

Toepasbare draairichting

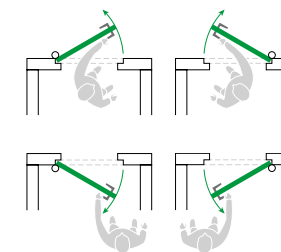

Artikelnummer	Materiaal/kleur/finish	Klein-verpakking	Groot-verpakking	Minimaal bestelaantal	Aanbevolen bevestiging
7480-50-81/E	voorplaat RVS	5	20	5	4.0 x 40 mm
7480-60-81/E	voorplaat RVS	5	20	5	4.0 x 40 mm

Artikelnummer	Materiaal/kleur/finish	Klein-verpakking	Groot-verpakking	Minimaal bestelaantal	Aanbevolen bevestiging
7485-50-81/E	voorplaat RVS	5	20	5	4.0 x 40 mm
7485-60-81/E	voorplaat RVS	5	20	5	4.0 x 40 mm

Bijzonderheden:
/E = EAN sticker direct op product

Voorboren
ø 2,0 mm

Bijzonderheden:
/E = EAN sticker direct op product

Voorboren
ø 2,0 mm

VEILIGHEIDS SLUITKOMMEN

SLUITPLATEN VEILIGHEIDS DEURSLOTEN

TYPE 7415-35
Veiligheids sluitkom
voor slot 7415

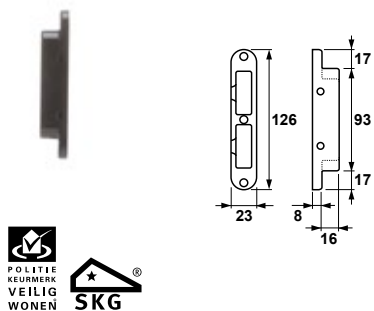

TYPE 7421-45
Veiligheids sluitkom
voor slot 7421 en 7426

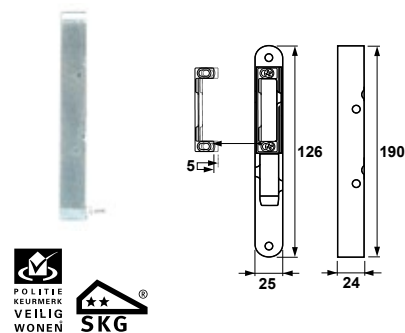

TYPE 7420-45
Veiligheids sluitkom
voor slot 7420 en 7425

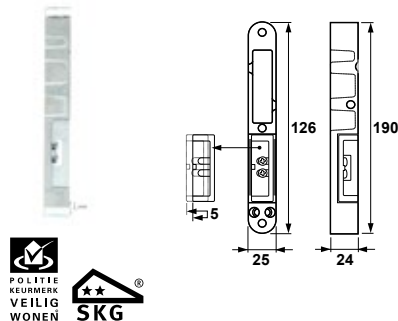

TYPE 7480-35
Veiligheids sluitkom
voor bijzetslot 7480 en 7485

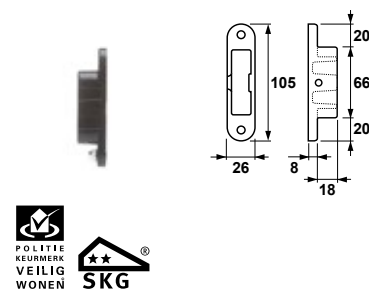

Artikelnummer	Materiaal/kleur/finish	PC	Klein-verpakking	Groot-verpakking	Minimaal bestelaantal	Aanbevolen bevestiging
7415-35-66/55E	zamac zwart	55	1	40	1	4,0 x 45 mm 4,0 x 35 mm
7420-45-64/E	zamac galvanisch verzinkt	55/72	1	20	1	4,0 x 45 mm
7421-45-64/E	zamac galvanisch verzinkt	55/72	1	20	1	4,0 x 45 mm
7480-35-66/E	zamac zwart	-	1	48	1	4,0 x 45 mm 4,0 x 35 mm

Bijzonderheden:
/E = EAN sticker direct op product

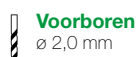

TYPE 7410-15-81/55EL
Sluitplaat
voor sluitkom 7415

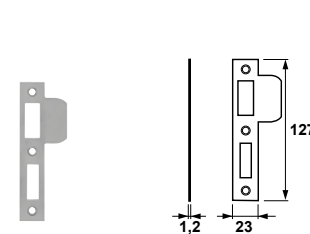

TYPE 7420-10-81/55EL
Sluitplaat
voor sluitkom 7420

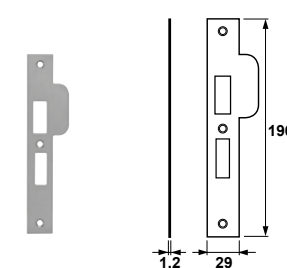

TYPE 7415-15-81/55EL
Sluitplaat
voor sluitkom 7415

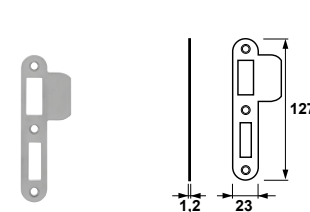

TYPE 7420-10-81/72EL
Sluitplaat
voor sluitkom 7420

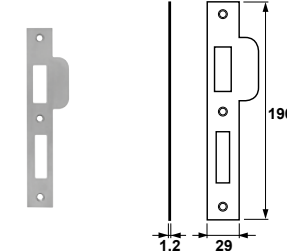

Artikelnummer	Materiaal/kleur/finish	PC	Klein-verpakking	Groot-verpakking	Minimaal bestelaantal	Aanbevolen bevestiging
7410-15-81/55EL	RVS / DIN links	55	10	240	10	4,0 x 45 mm
7410-15-81/55ER	RVS / DIN rechts	55	10	240	10	4,0 x 45 mm
7415-15-81/55EL	RVS / DIN links	55	10	240	10	4,0 x 45 mm
7415-15-81/55ER	RVS / DIN rechts	55	10	240	10	4,0 x 45 mm
7420-10-81/55EL	RVS / DIN links	55	10	160	10	4,0 x 45 mm
7420-10-81/55ER	RVS / DIN rechts	55	10	160	10	4,0 x 45 mm
7420-10-81/72EL	RVS / DIN links	72	10	160	10	4,0 x 45 mm
7420-10-81/72ER	RVS / DIN rechts	72	10	160	10	4,0 x 45 mm

Bijzonderheden:
/E = EAN sticker direct op product



SLUITPLATEN VEILIGHEIDS SLOTEN

SLUITPLATEN VEILIGHEIDS SLOTEN

TYPE 7425-15-81/55EL

Sluitplaat

voor sluitkom 7420

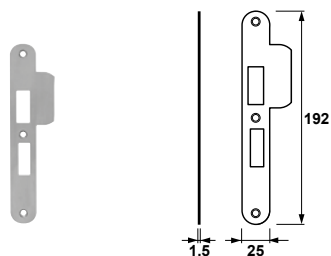

TYPE 7425-25-81/55EL

Sluitplaat

voor sluitkom 7420

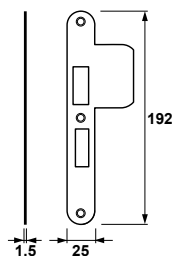

TYPE 7425-15-81/72EL

Sluitplaat

voor sluitkom 7420

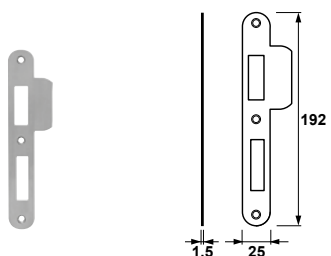

TYPE 7425-25-81/72EL

Sluitplaat

voor sluitkom 7420

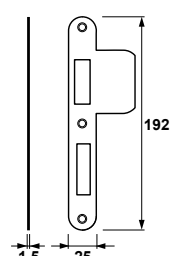

TYPE 7421-10-81/55EL

Sluitplaat

voor sluitkom 7421

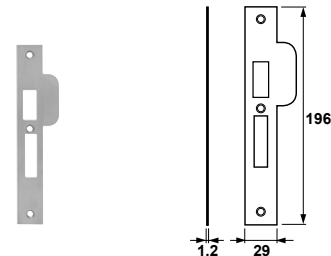

TYPE 7426-25-81/55EL

Sluitplaat

voor sluitkom 7421

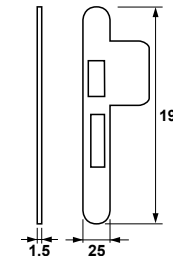

TYPE 7426-15-81/55EL

Sluitplaat

voor sluitkom 7421

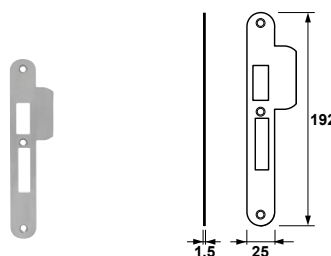

Artikelnummer	Materiaal/kleur/finish	PC	Klein-verpakking	Groot-verpakking	Minimaal bestelaantal	Aanbevolen bevestiging
7425-15-81/55EL	RVS / DIN links	55	10	160	10	4,0 x 45 mm
7425-15-81/55ER	RVS / DIN rechts	55	10	160	10	4,0 x 45 mm
7425-15-81/72EL	RVS / DIN links	72	10	160	10	4,0 x 45 mm
7425-15-81/72ER	RVS / DIN rechts	72	10	160	10	4,0 x 45 mm
7425-25-81/55EL	RVS / DIN links	55	10	160	10	4,0 x 45 mm
7425-25-81/55ER	RVS / DIN rechts	55	10	160	10	4,0 x 45 mm
7425-25-81/72EL	RVS / DIN links	72	10	160	10	4,0 x 45 mm
7425-25-81/72ER	RVS / DIN rechts	72	10	160	10	4,0 x 45 mm

Bijzonderheden:
/E = EAN sticker direct op product

Voorboren
ø 2,0 mm

Artikelnummer	Materiaal/kleur/finish	PC	Klein-verpakking	Groot-verpakking	Minimaal bestelaantal	Aanbevolen bevestiging
7421-10-81/55EL	RVS / DIN links	55	10	160	10	4,0 x 45 mm
7421-10-81/55ER	RVS / DIN rechts	55	10	160	10	4,0 x 45 mm
7426-15-81/55EL	RVS / DIN links	55	10	160	10	4,0 x 45 mm
7426-15-81/55ER	RVS / DIN rechts	55	10	160	10	4,0 x 45 mm
7426-25-81/55EL	RVS / DIN links	55	10	160	10	4,0 x 45 mm
7426-25-81/55ER	RVS / DIN rechts	55	10	160	10	4,0 x 45 mm

Bijzonderheden:
/E = EAN sticker direct op product

Voorboren
ø 2,0 mm

7490 OPLEGDEURSLOT

Toepassing

voor buitendeuren



TYPE 7490-51

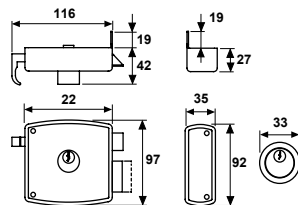

Productpositie

Deur

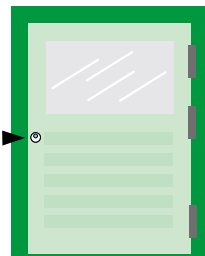

Toepasbare draairichting

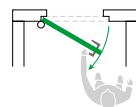

Artikelnummer	Materiaal/kleur/finish	Klein-verpakking	Groot-verpakking	Minimaal bestelaantal	Aanbevolen bevestiging
7490-51-49	staal grijs	1	4	4	4,0 x 20 mm / 3,5 x 40 mm

Vorboren
ø 2,0 mm

OPLEGDEURSLOT 7490

Toepassing

voor buitendeuren



TYPE 7490-52

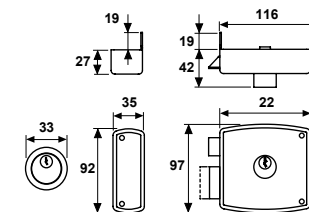

Productpositie

Deur

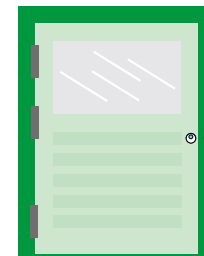

Toepasbare draairichting

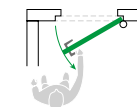

Artikelnummer	Materiaal/kleur/finish	Klein-verpakking	Groot-verpakking	Minimaal bestelaantal	Aanbevolen bevestiging
7490-52-49	staal grijs	1	4	4	4,0 x 20 mm / 3,5 x 40 mm

Vorboren
ø 2,0 mm

7312 OPLEGGRENDELSLOT



Toepassing
voor schuur of poortdeuren

TYPE 7312

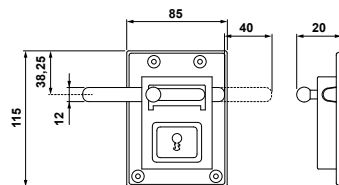

Productpositie

Deur

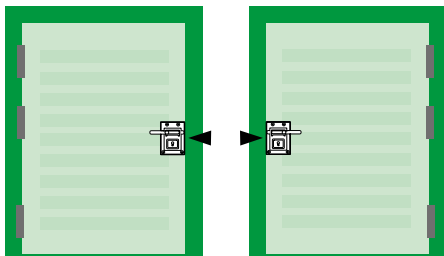

Toepasbare draairichting

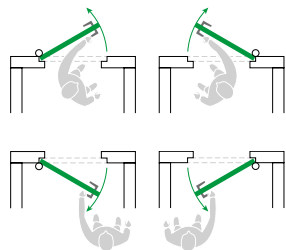

Artikelnummer	Materiaal/kleur/finish	Klein-verpakking	Groot-verpakking	Minimaal bestelaantal	Aanbevolen bevestiging
7312-00-22/E	galvanisch verzinkt	-	8	8	3,0 x 30 mm

Bijzonderheden:
/E = EAN sticker direct op product

Voorboren
ø 2,0 mm

OPLEGDEURSLOT 7313



Toepassing
voor schuur of poortdeuren

TYPE 7313

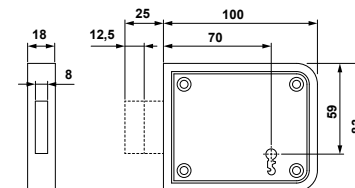

Productpositie

Deur

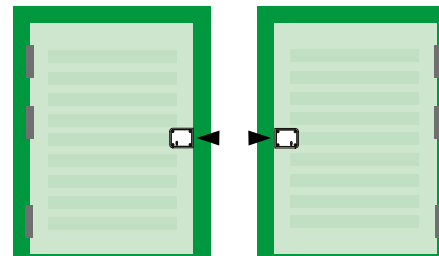

Toepasbare draairichting

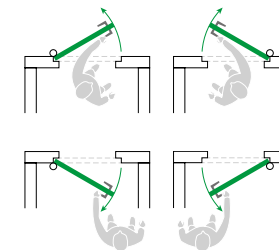

Artikelnummer	Materiaal/kleur/finish	Klein-verpakking	Groot-verpakking	Minimaal bestelaantal	Aanbevolen bevestiging
7313-70-22/E	galvanisch verzinkt	-	10	10	4,0 x 40 mm

Bijzonderheden:
/E = EAN sticker direct op product

Voorboren
ø 2,0 mm

7488 VEILIGHEIDS PENBIJZETSLOT



Toepassing
voor buitendeuren



TYPE 7488

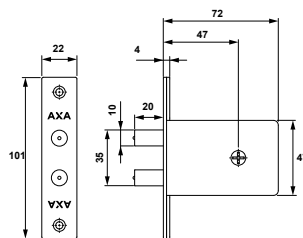

Productpositie

Deur

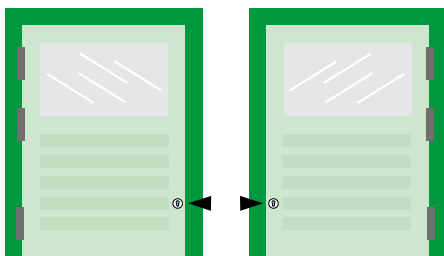

Toepasbare draairichting

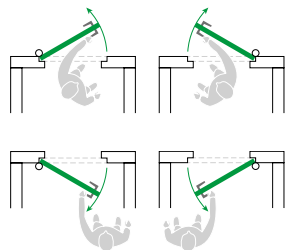

Artikelnummer	Materiaal/kleur/finish	Klein-verpakking	Groot-verpakking	Minimaal bestelaantal	Aanbevolen bevestiging
7488-47-37/E	staal galvanisch verzinkt	-	6	6	4.0 x 40 mm / 3.0 x 12 mm
7488-47-37/E2	staal galvanisch verzinkt	-	3 (2 st.)	3 (2 st.)	4.0 x 40 mm / 3.0 x 12 mm

Bijzonderheden:
/E = EAN sticker direct op product | 2 st. = 2 producten per kleinverpakking

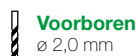

Deurcilinders

Inhoudsopgave

Pagina

Cilinders	300
Veiligheids cilinders Security	303
Veiligheids cilinders Comfort & Security	307
Veiligheids cilinders Ultimate Security	311
Veiligheids cilinders Xtreme Security	312



7200 CILINDER



Toepassing
voor binnendeuren

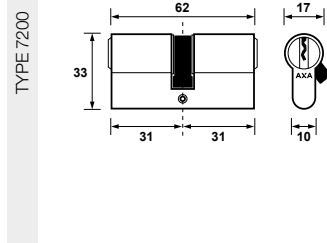

Productpositie

Deur

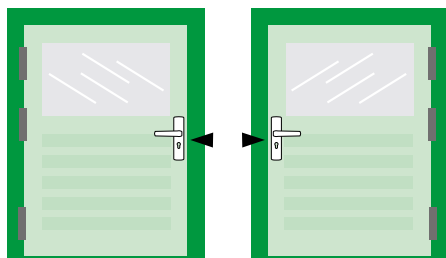

Toepasbare draairichting

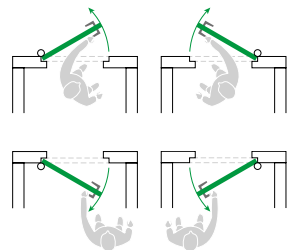

Artikelnummer	Materiaal/kleur/finish	Klein-verpakking	Groot-verpakking	Minimaal bestelaantal	Aanbevolen bevestiging
7200-00-08/BL*	messing vernikkeld	1	8	1	M5 x 70 mm
7200-00-08/BL2*	messing vernikkeld	1	8	1	M5 x 70 mm
7200-00-08/BL3*	messing vernikkeld	1	6	1	M5 x 70 mm

Bijzonderheden:
/* = uitsluitend leverbaar in blisterverpakking | /BL2 = 2 stuks, gelijksluitend | /BL3 = 3 stuks, gelijksluitend

Voorboren
ø 6,0 mm

CILINDER 7203



Toepassing
voor binnendeuren

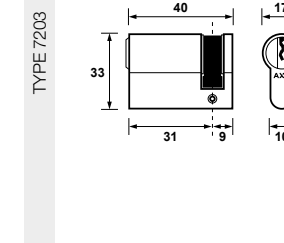

Productpositie

Deur

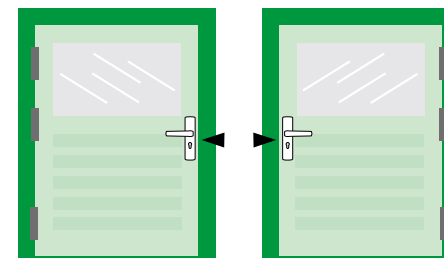

Toepasbare draairichting

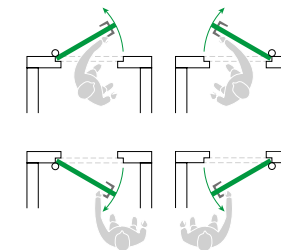

Artikelnummer	Materiaal/kleur/finish	Klein-verpakking	Groot-verpakking	Minimaal bestelaantal	Aanbevolen bevestiging
7203-00-08/BL*	messing vernikkeld	1	8	1	M5 x 70 mm

Bijzonderheden:
/* = uitsluitend leverbaar in blisterverpakking

Voorboren
ø 6,0 mm

7205 CILINDER

Toepassing
voor binnendeuren



TYPE 7205

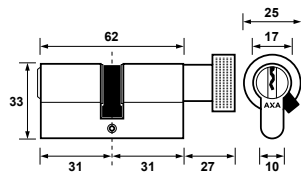

Productpositie

Deur

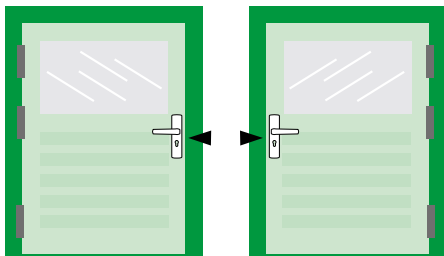

Toepasbare draairichting

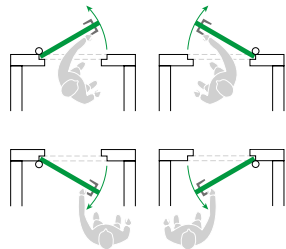

Artikelnummer	Materiaal/kleur/finish	Klein-verpakking	Groot-verpakking	Minimaal bestelaantal	Aanbevolen bevestiging
7205-00-08/BL*	messing vernikkeld	1	8	1	M5 x 70 mm

Bijzonderheden:
/* = uitsluitend leverbaar in blisterverpakking

Voorboren
ø 6,0 mm

VEILIGHEIDS CILINDER SECURITY 7211

Toepassing
voor buitendeuren



TYPE 7211-00

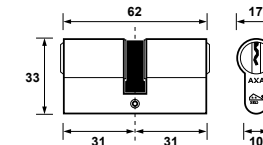

Productpositie

Deur

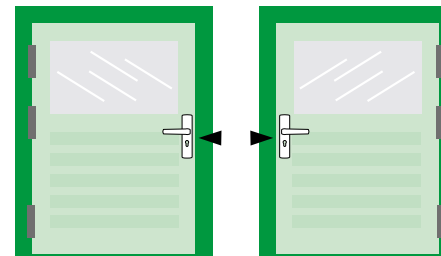

Toepasbare draairichting

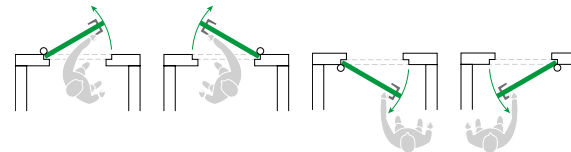

Artikelnummer	Materiaal/kleur/finish	Klein-verpakking	Groot-verpakking	Minimaal bestelaantal	Aanbevolen bevestiging
7211-00-00/BL*	messing vernikkeld	1	8	1	M5 x 70 mm
7211-00-08/BL*	messing vernikkeld	1	8	1	M5 x 70 mm
7211-00-08/BL2*	messing vernikkeld	1	8	1	M5 x 70 mm
7211-00-08/BL3*	messing vernikkeld	1	6	1	M5 x 70 mm
7211-00-08/BL4*	messing vernikkeld	1	6	1	M5 x 70 mm

Bijzonderheden:
/* = uitsluitend leverbaar in blisterverpakking | /BL2 = 2 stuks, gelijksluitend
/BL3 = 3 stuks, gelijksluitend | /BL4 = 4 stuks, gelijksluitend

Voorboren
ø 6,0 mm

7211 VEILIGHEIDS CILINDER SECURITY verlengd

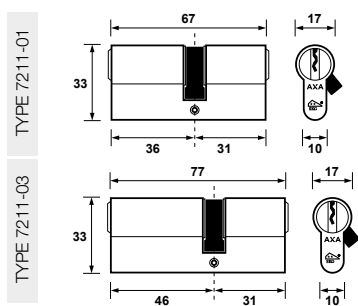

Productpositie

Deur

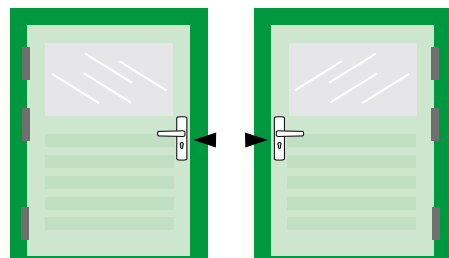

Toepasbare draairichting

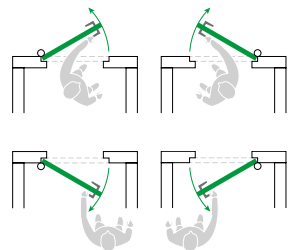

Artikelnummer	Materiaal/kleur/finish	Klein-verpakking	Groot-verpakking	Minimaal bestelaantal	Aanbevolen bevestiging
7211-01-08/BL*	messing vernikkeld	1	8	1	M5 x 70 mm
7211-03-08/BL*	messing vernikkeld	1	8	1	M5 x 70 mm

Bijzonderheden:
/* = uitsluitend leverbaar in blisterverpakking

Voorboren
ø 6,0 mm

VEILIGHEIDS CILINDER SECURITY enkel 7213

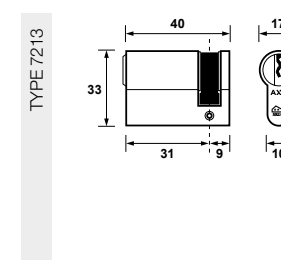

Productpositie

Deur

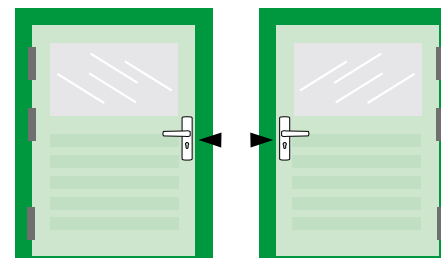

Toepasbare draairichting

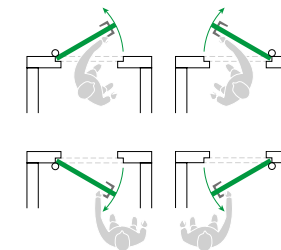

Artikelnummer	Materiaal/kleur/finish	Klein-verpakking	Groot-verpakking	Minimaal bestelaantal	Aanbevolen bevestiging
7213-00-08/BL*	messing vernikkeld	1	8	1	M5 x 70 mm

Bijzonderheden:
/* = uitsluitend leverbaar in blisterverpakking

Voorboren
ø 6,0 mm

7215 VEILIGHEIDS CILINDER SECURITY knop

VEILIGHEIDS CILINDER COMFORT & SECURITY 7231

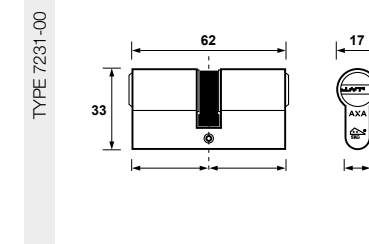
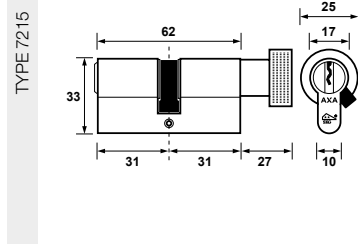

Productpositie

Deur

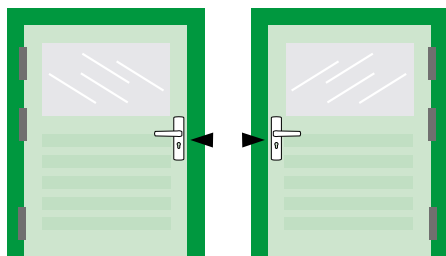

Productpositie

Deur

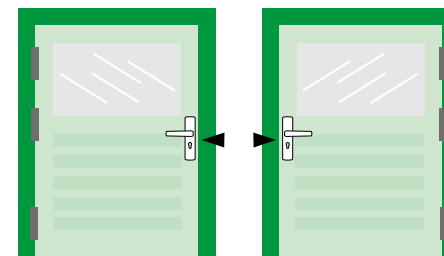

Toepasbare draairichting

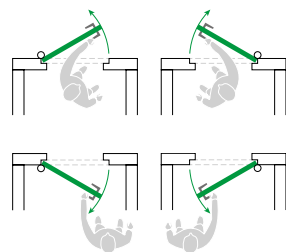

Toepasbare draairichting

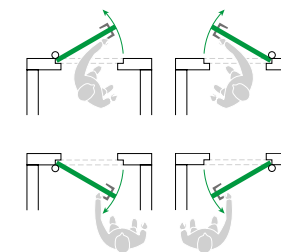

Artikelnummer	Materiaal/kleur/finish	Klein-verpakking	Groot-verpakking	Minimaal bestelaantal	Aanbevolen bevestiging
7215-00-08/BL*	messing vernikkeld	1	8	1	M5 x 70 mm

Bijzonderheden:
/* = uitsluitend leverbaar in blisterverpakking

Voorboren
ø 6,0 mm

Artikelnummer	Materiaal/kleur/finish	Klein-verpakking	Groot-verpakking	Minimaal bestelaantal	Aanbevolen bevestiging
7231-00-08/BL*	messing vernikkeld	1	8	1	M5 x 70 mm
7231-00-08/BL2*	messing vernikkeld	1	8	1	M5 x 70 mm
7231-00-08/BL3*	messing vernikkeld	1	6	1	M5 x 70 mm

Bijzonderheden:
/* = uitsluitend leverbaar in blisterverpakking | /BL2 = 2 stuks, gelijksluitend

Voorboren
ø 6,0 mm

7231 VEILIGH. CILINDER COMFORT & SECURITY verlengd

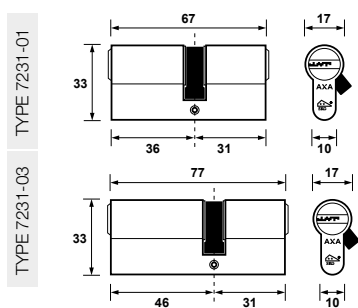

Productpositie

Deur

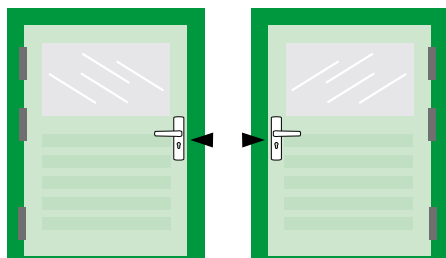

Toepasbare draairichting

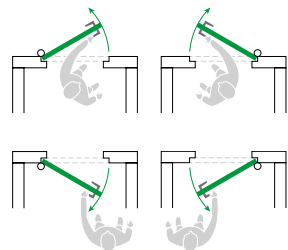

Artikelnummer	Materiaal/kleur/finish	Klein-verpakking	Groot-verpakking	Minimaal bestelaantal	Aanbevolen bevestiging
7231-01-08/BL*	messing vernikkeld	1	8	1	M5 x 70 mm
7231-03-08/BL*	messing vernikkeld	1	8	1	M5 x 70 mm

Bijzonderheden:
/* = uitsluitend leverbaar in blisterverpakking

Voorboren
ø 6,0 mm

VEILIGHEIDS CILINDER COMFORT & SECURITY enkel 7233

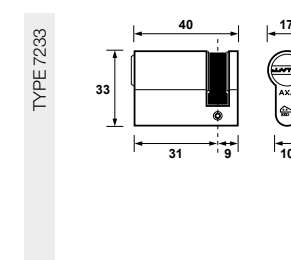

Productpositie

Deur

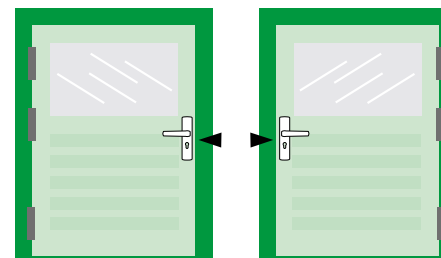

Toepasbare draairichting

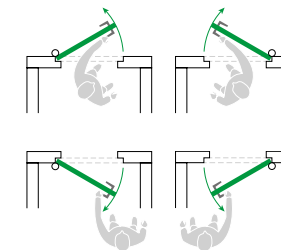

Artikelnummer	Materiaal/kleur/finish	Klein-verpakking	Groot-verpakking	Minimaal bestelaantal	Aanbevolen bevestiging
7233-00-08/BL*	messing vernikkeld	1	8	1	M5 x 70 mm

Bijzonderheden:
/* = uitsluitend leverbaar in blisterverpakking

Voorboren
ø 6,0 mm

7235 VEILIGHEIDS CILINDER COMFORT & SECURITY knop

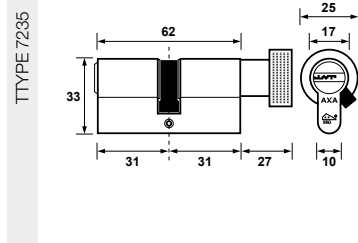

Productpositie
Deur

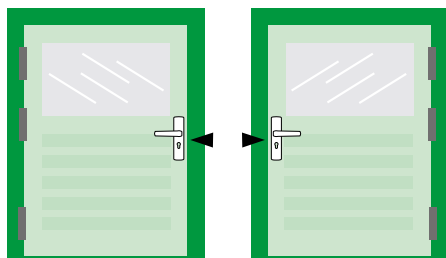

Toepasbare draairichting

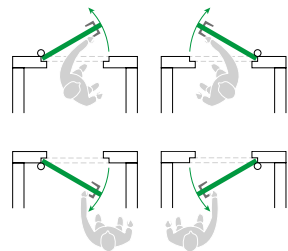

Artikelnummer	Materiaal/kleur/finish	Klein-verpakking	Groot-verpakking	Minimaal bestelaantal	Aanbevolen bevestiging
7235-00-08/BL*	messing vernikkeld	1	8	1	M5 x 70 mm

Bijzonderheden:
/* = uitsluitend leverbaar in blisterverpakking

Vorboren
ø 6,0 mm

VEILIGHEIDS CILINDER ULTIMATE SECURITY 7251

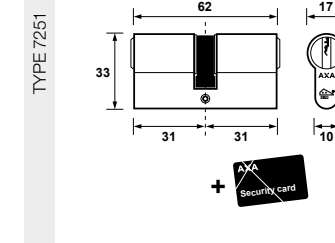

Productpositie
Deur

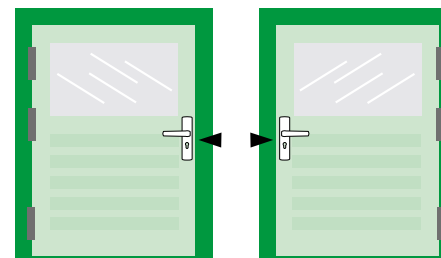

Toepasbare draairichting

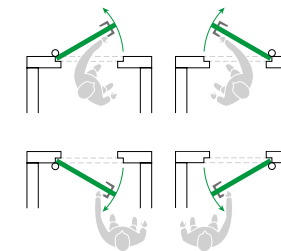

Artikelnummer	Materiaal/kleur/finish	Klein-verpakking	Groot-verpakking	Minimaal bestelaantal	Aanbevolen bevestiging
7251-00-08/BL*	messing vernikkeld	1	8	1	M5 x 70 mm
7251-00-08/BL2*	messing vernikkeld	1	8	1	M5 x 70 mm

Bijzonderheden:
/* = uitsluitend leverbaar in blisterverpakking | /BL2 = 2 stuks, gelijksluitend

Vorboren
ø 6,0 mm

7261 VEILIGHEIDS CILINDER XTREME SECURITY



Toepassing
voor buitendeuren

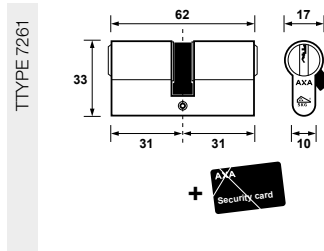

Productpositie

Deur

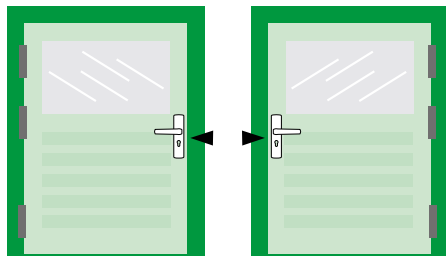

Toepasbare draairichting

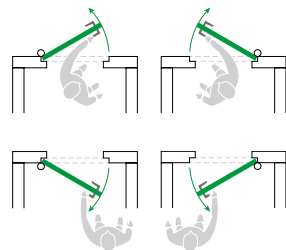

Artikelnummer	Materiaal/kleur/finish	Klein-verpakking	Groot-verpakking	Minimaal bestelaantal	Aanbevolen bevestiging
7261-00-08/BL*	messing vernikkeld	1	8	1	M5 x 70 mm
7261-00-08/BL2*	messing vernikkeld	1	8	1	M5 x 70 mm

Bijzonderheden:
/* = uitsluitend leverbaar in blisterverpakking | /BL2 = 2 stuks, gelijksluitend



Overige deurproducten

Inhoudsopgave

Pagina

Deur beveiligings strips M2-IN (naar binnen)	314
Deur beveiligings strips M3-EX (naar buiten)	315
Kierstandhouders	320
Inboorgrendels	323
Deurspionnen	326
Deurstoppers	329



7602/7606 DEURBEVEILIGINGSSTRIP M2-IN

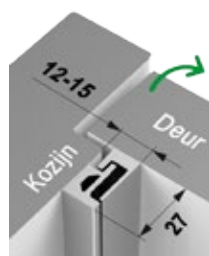

Toepassing
voor buitendeuren

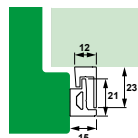

TYPE 7602



TYPE 7606

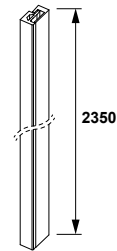

Productpositie

Deur

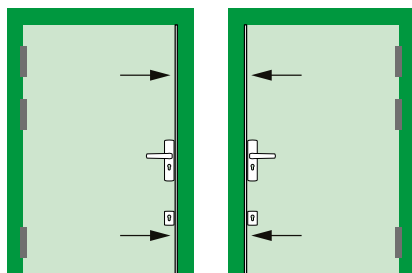

Benodigde montageruimte

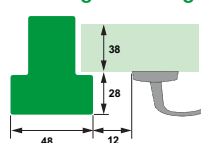

Toepasbare draairichting

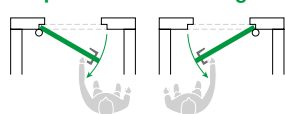

Artikelnummer	Materiaal/kleur/finish	Klein-verpakking	Groot-verpakking	Minimaal bestelaantal	Aanbevolen bevestiging
7602-00-88/BL*	aluminium wit	1	6	1	4.0 x 40 mm / 4.0 x 50 mm
7602-00-91/BL*	aluminium geanodiseerd F1	1	6	1	4.0 x 40 mm / 4.0 x 50 mm
7606-00-88/BL*	aluminium wit	1	6	1	4.0 x 40 mm / 4.0 x 50 mm
7606-00-91/BL*	aluminium geanodiseerd F1	1	6	1	4.0 x 40 mm / 4.0 x 50 mm

Bijzonderheden:
* = uitsluitend leverbaar in tubeverpakking



DEURBEVEILIGINGSSTRIP M3-EX 0-4

7603/7607

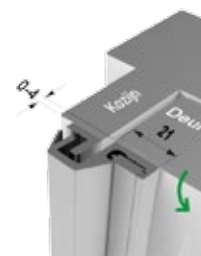

Toepassing
voor buitendeuren

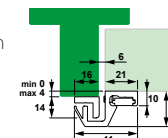

TYPE 7603

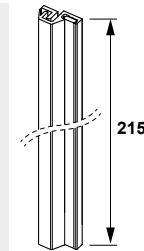

TYPE 7607

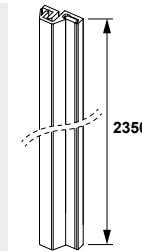

Productpositie

Deur

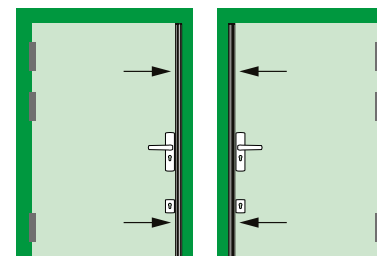

Benodigde montageruimte

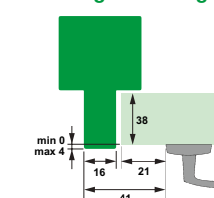

Toepasbare draairichting

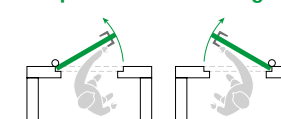

Artikelnummer	Materiaal/kleur/finish	Klein-verpakking	Groot-verpakking	Minimaal bestelaantal	Aanbevolen bevestiging
7603-00-88/BL*	aluminium wit	1	6	1	4.0 x 40 mm
7603-00-91/BL*	aluminium geanodiseerd F1	1	6	1	4.0 x 40 mm
7607-00-88/BL*	aluminium wit	1	6	1	4.0 x 40 mm
7607-00-91/BL*	aluminium geanodiseerd F1	1	6	1	4.0 x 40 mm

Bijzonderheden:
* = uitsluitend leverbaar in tubeverpakking



7603/7607 DEURBEVEILIGINGSSTRIP M3-EX 5-9

DEURBEVEILIGINGSSTRIP M3-EX 10-14 7603/7607

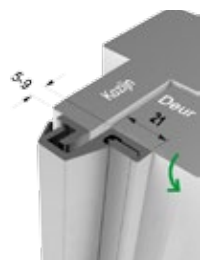

Toepassing
voor buitendeuren

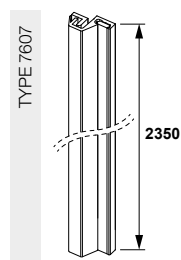
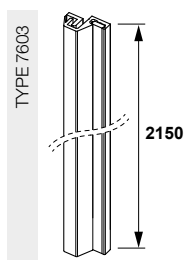
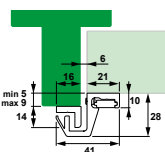

Productpositie

Deur

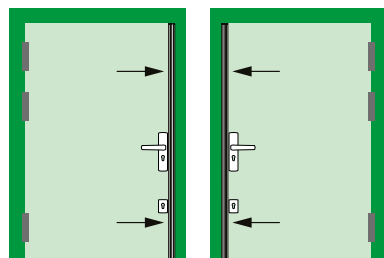

Benodigde montageruimte

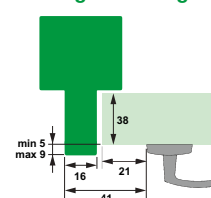

Toepasbare draairichting

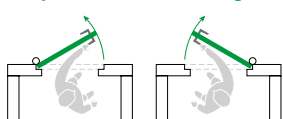

Artikelnummer	Materiaal/kleur/finish	Klein-verpakking	Groot-verpakking	Minimaal bestelaantal	Aanbevolen bevestiging
7603-05-88/BL*	aluminium wit	1	6	1	4,0 x 40 mm
7603-05-91/BL*	aluminium geanodiseerd F1	1	6	1	4,0 x 40 mm
7607-05-88/BL*	aluminium wit	1	6	1	4,0 x 40 mm
7607-05-91/BL*	aluminium geanodiseerd F1	1	6	1	4,0 x 40 mm

Bijzonderheden:
* = uitsluitend leverbaar in tubeverpakking

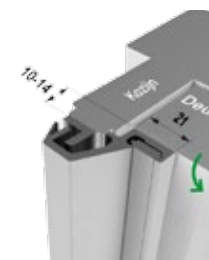

Toepassing
voor buitendeuren

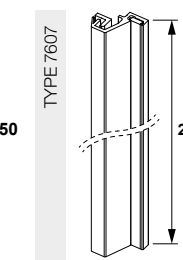
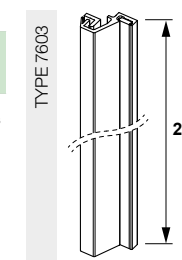
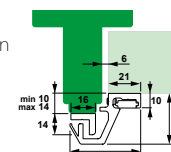

Productpositie

Deur

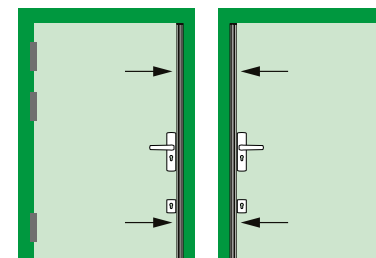

Benodigde montageruimte

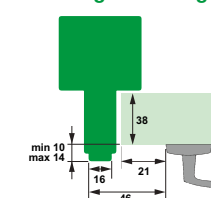

Toepasbare draairichting

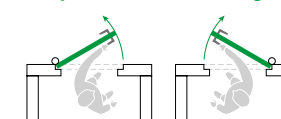

Artikelnummer	Materiaal/kleur/finish	Klein-verpakking	Groot-verpakking	Minimaal bestelaantal	Aanbevolen bevestiging
7603-10-88/BL*	aluminium wit	1	6	1	4,0 x 40 mm
7603-10-91/BL*	aluminium geanodiseerd F1	1	6	1	4,0 x 40 mm
7607-10-88/BL*	aluminium wit	1	6	1	4,0 x 40 mm
7607-10-91/BL*	aluminium geanodiseerd F1	1	6	1	4,0 x 40 mm

Bijzonderheden:
* = uitsluitend leverbaar in tubeverpakking



7603/7607 DEURBEVEILIGINGSSTRIP M3-EX 15-19

DEURBEVEILIGINGSSTRIP M3-EX 20-25 7603/7607



Toepassing
voor buitendeuren

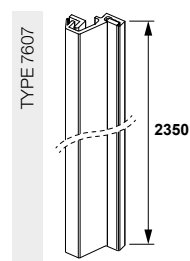
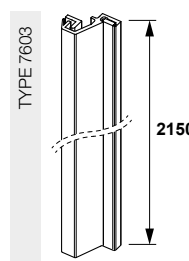
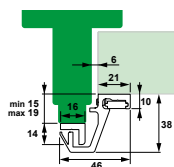

Productpositie

Deur

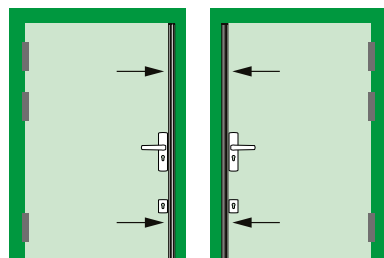

Benodigde montageruimte

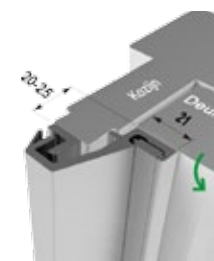
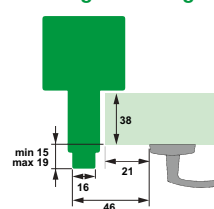

Toepassing
voor buitendeuren

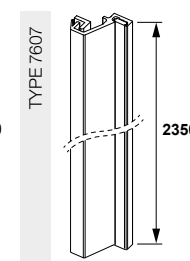
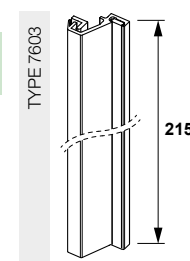
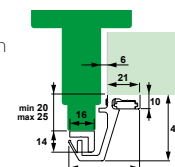

Productpositie

Deur

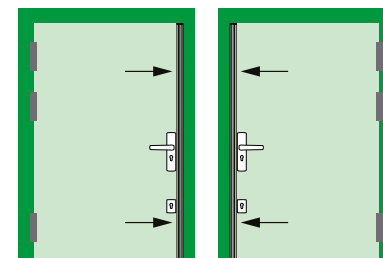

Benodigde montageruimte

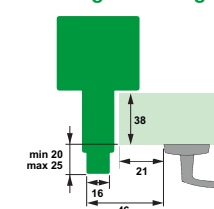

Toepasbare draairichting

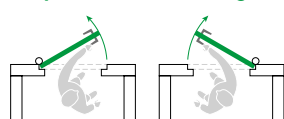

Toepasbare draairichting

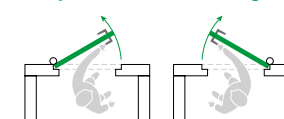

Artikelnummer	Materiaal/kleur/finish	Klein-verpakking	Groot-verpakking	Minimaal bestelaantal	Aanbevolen bevestiging
7603-15-88/BL*	aluminium wit	1	6	1	4.0 x 40 mm
7603-15-91/BL*	aluminium geanodiseerd F1	1	6	1	4.0 x 40 mm
7607-15-88/BL*	aluminium wit	1	6	1	4.0 x 40 mm
7607-15-91/BL*	aluminium geanodiseerd F1	1	6	1	4.0 x 40 mm

Bijzonderheden:
* = uitsluitend leverbaar in tubeverpakking



Artikelnummer	Materiaal/kleur/finish	Klein-verpakking	Groot-verpakking	Minimaal bestelaantal	Aanbevolen bevestiging
7603-20-88/BL*	aluminium wit	1	6	1	4.0 x 40 mm
7603-20-91/BL*	aluminium geanodiseerd F1	1	6	1	4.0 x 40 mm
7607-20-88/BL*	aluminium wit	1	6	1	4.0 x 40 mm
7607-20-91/BL*	aluminium geanodiseerd F1	1	6	1	4.0 x 40 mm

Bijzonderheden:
* = uitsluitend leverbaar in tubeverpakking



7351 KIERSTANDHOUDER IN

Toepassing

voor voordeuren



TYPE 7351

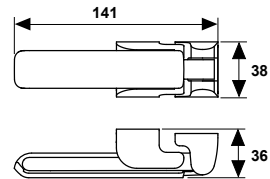

Productpositie

Deur

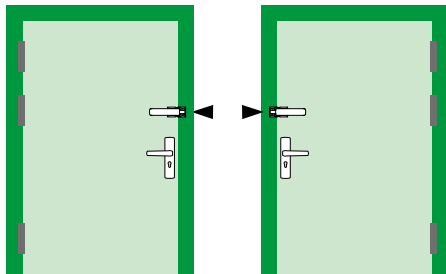

Benodigde montageruimte

7351-20-81

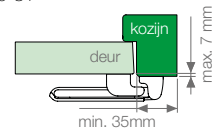

7351-21-81

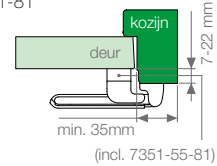

7351-21-81

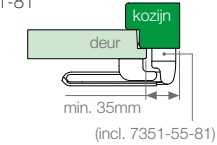

Toepasbare draairichting

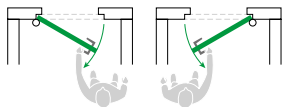

Artikelnummer	Materiaal/kleur/finish	Klein-verpakking	Groot-verpakking	Minimaal bestelaantal	Aanbevolen bevestiging
7351-20-81*	RVS	1	30	1	4,0 x 40 mm
7351-21-81**	RVS	1	30	1	4,0 x 40 mm

Bijzonderheden:
* = gelijkliggend | /** = opdek

Voorboren
ø 2,0 mm

KIERSTANDHOUDER EX 7355

Toepassing

voor achterdeuren



TYPE 7355

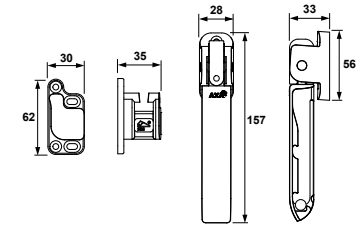

Productpositie

Deur

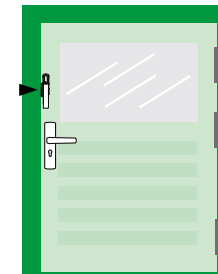

Benodigde montageruimte

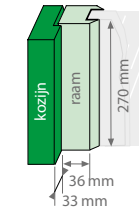

Toepasbare draairichting

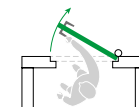

Artikelnummer	Materiaal/kleur/finish	Klein-verpakking	Groot-verpakking	Minimaal bestelaantal	Aanbevolen bevestiging
7355-15-81/L*	RVS geborsteld	1	30	1	4,5 x 40 mm / 4,5 x 50 mm

Voorboren
ø 3,0 mm

7355 KIERSTANDHOUDER EX



Toepassing
voor achterdeuren

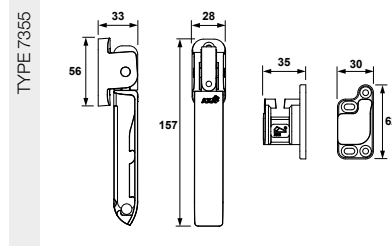

Productpositie

Deur

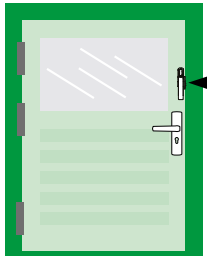

Benodigde montage-ruimte

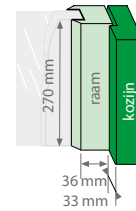

Toepasbare draairichting

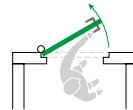

Artikelnummer	Materiaal/kleur/finish	Klein-verpakking	Groot-verpakking	Minimaal bestelaantal	Aanbevolen bevestiging
7355-15-81/R*	RVS geborsteld	1	30	1	4,5 x 40 mm / 4,5 x 50 mm

Voorboren
ø 3,0 mm

INBOORGRENDEL 7320



Toepassing
voor buitendeuren

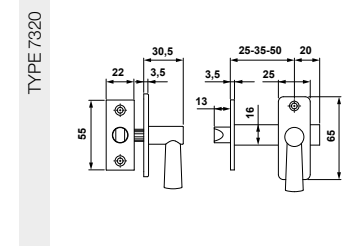

Productpositie

Deur

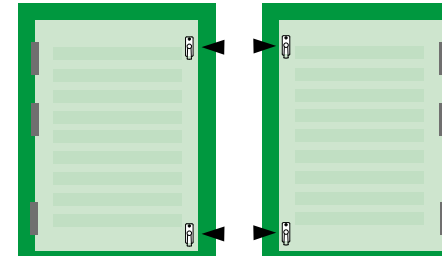

Toepasbare draairichting

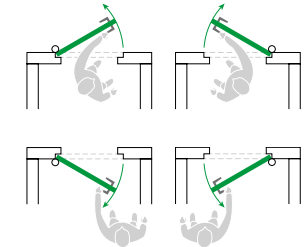

Artikelnummer	Materiaal/kleur/finish	DM	Klein-verpakking	Groot-verpakking	Minimaal bestelaantal	Aanbevolen bevestiging
7320-25-91/E	voorplaat RVS	25	3	12	3	3,5 x 20 mm
7320-35-91/E	voorplaat RVS	35	3	12	3	3,5 x 20 mm
7320-50-91/E	voorplaat RVS	50	3	12	3	3,5 x 20 mm

Bijzonderheden:
/E = EAN sticker direct op product

Voorboren
ø 1,5 mm

7321 INBOORGRENDEL



Toepassing
voor buitendeuren

TYPE 7321

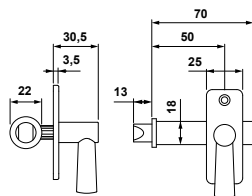

Productpositie

Deur

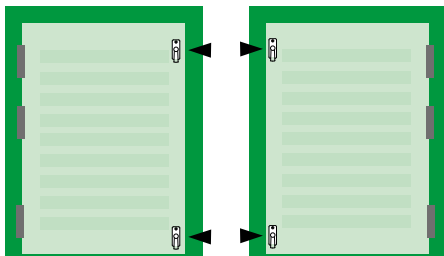

Toepasbare draairichting

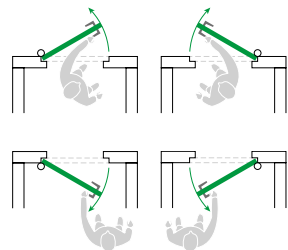

Artikelnummer	Materiaal/kleur/finish	DM	Klein-verpakking	Groot-verpakking	Minimaal bestelaantal	Aanbevolen bevestiging
7321-50-91/E	voorplaat RVS	50	3	12	3	3,5 x 20 mm

Bijzonderheden:
/E = EAN sticker direct op product

Voorboren
ø 2,0 mm

INBOORGRENDEL 7325



Toepassing
voor buitendeuren

TYPE 7325

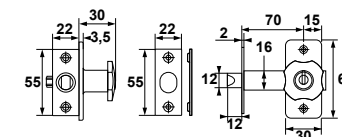

Productpositie

Deur

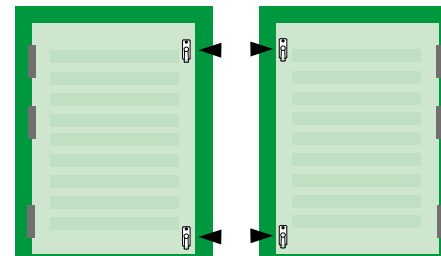

Toepasbare draairichting

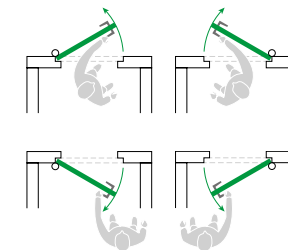

Artikelnummer	Materiaal/kleur/finish	DM	Klein-verpakking	Groot-verpakking	Minimaal bestelaantal	Aanbevolen bevestiging
7325-50-91/E	voorplaat RVS	50	3	12	3	3,5 x 20 mm

Bijzonderheden:
/E = EAN sticker direct op product

Voorboren
ø 2,0 mm

7800 DIGITALE DEURSPION

DIGITALE DEURSPION MET DEURBEL 7820

Toepassing

voor buitendeuren



TYPE 7800

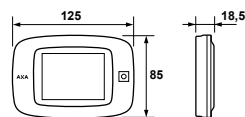

Toepassing

voor buitendeuren



TYPE 7820

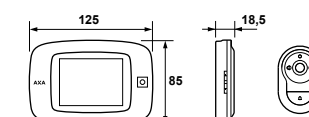

Productpositie

Deur

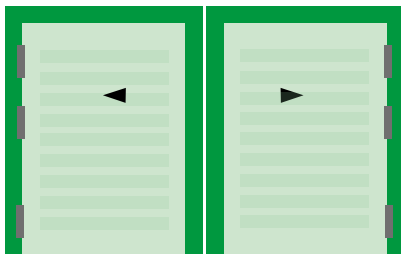

Productpositie

Deur

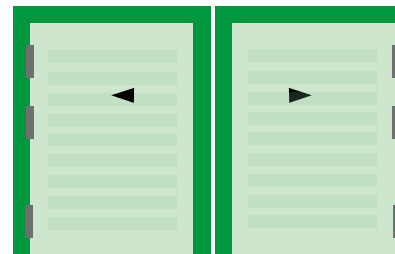

Toepasbare draairichting

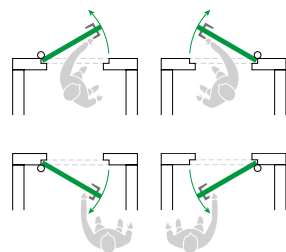

Toepasbare draairichting

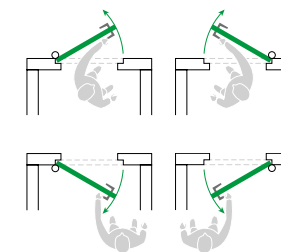

Artikelnummer	Materiaal/kleur/finish	Klein-verpakking	Groot-verpakking	Minimaal bestelaantal	Aanbevolen bevestiging
7800-00-90	kunststof zilver	1	8	1	

Voorboren
ø 2,0 mm

Artikelnummer	Materiaal/kleur/finish	Klein-verpakking	Groot-verpakking	Minimaal bestelaantal	Aanbevolen bevestiging
7820-00-90	kunststof zilver	1	8	1	

Voorboren
ø 2,0 mm

7831 DEURSPION



Toepassing
voor buitendeuren

TYPE 7831

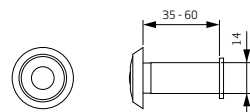

Productpositie

Deur

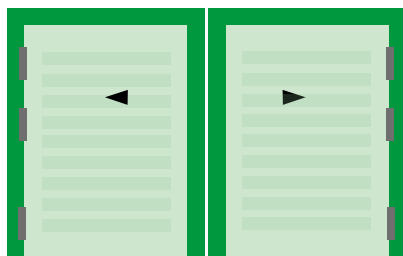

Toepasbare draairichting

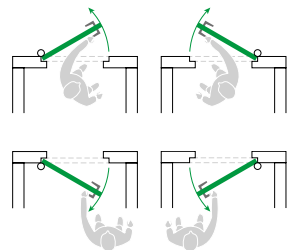

Artikelnummer	Materiaal/kleur/finish	Klein-verpakking	Groot-verpakking	Minimaal bestelaantal	Aanbevolen bevestiging
7831-00-62/E	messing mat vernikkeld	4	16	4	-

Bijzonderheden:
/E = EAN sticker direct op product

Voorboren
ø 2,0 mm

DEURSTOPPERS 6900

Deurstopper FS 90
Los, geen montage

TYPE 6900-01

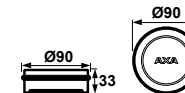

Deurstopper FS 35T
voor vloermontage

TYPE 6900-04

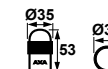

Deurstopper FS 45
voor vloermontage

TYPE 6900-02

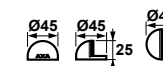

Deurstopper FS 48
voor vloermontage

TYPE 6900-05

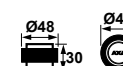

Deurstopper FS 35
voor vloermontage

TYPE 6900-03

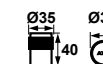

Deurstopper WS 16
voor wandmontage

TYPE 6900-06

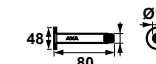

Deurstopper FS 65
voor vloermontage

TYPE 6900-07

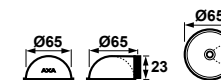

Artikelnummer	Materiaal/kleur/finish	Klein-verpakking	Groot-verpakking	Minimaal bestelaantal	Aanbevolen bevestiging
6900-01-81/E	roestvaststaal geborsteld	1	8	8	-
6900-02-81/E	roestvaststaal geborsteld	5	60	5	4,0 x 30 mm
6900-03-81/E	roestvaststaal geborsteld	5	60	5	5,0 x 50 mm
6900-04-81/E	roestvaststaal geborsteld	5	60	5	5,0 x 50 mm
6900-05-81/E	roestvaststaal geborsteld	5	60	5	5,0 x 50 mm
6900-06-81/E	roestvaststaal geborsteld	5	60	5	5,0 x 40 mm
6900-07-81/E	roestvaststaal geborsteld	3	36	3	5,0 x 50 mm

Bijzonderheden:
/E = EAN sticker direct op product

Voorboren
ø 2,0 mm

Overige raam- producten

Inhoudsopgave

Pagina

Barrièrestangen

332



7610 BARRIÈRESTANG V3 UNI

BARRIÈRESTANG V3 CURVE 7611

Toepassing
voor klepramen

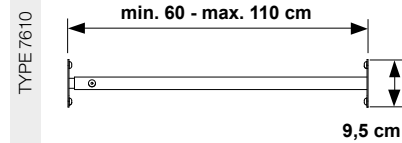

Toepassing
voor klepramen

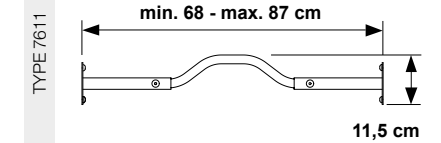

Productpositie

Klepraam

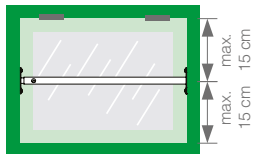

Benodigde montageruimte

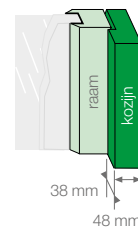

Productpositie

Klepraam

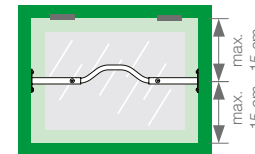

Benodigde montageruimte

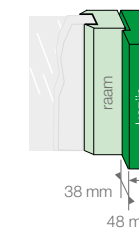

Toepasbare draairichting

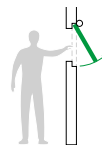

Toepasbare draairichting

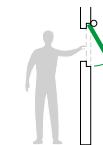

Artikelnummer	Materiaal/kleur/finish	Klein-verpakking	Groot-verpakking	Minimaal bestelaantal	Aanbevolen bevestiging
7610-60-54/BL*	staal wit	1	6	1	5.0 x 50 mm / 4.8 x 16 mm

Bijzonderheden:
* = uitsluitend leverbaar in tubeverpakking

Voorboren
ø 3,0 mm

Artikelnummer	Materiaal/kleur/finish	Klein-verpakking	Groot-verpakking	Minimaal bestelaantal	Aanbevolen bevestiging
7611-68-54/BL*	staal wit	1	6	1	5.0 x 50 mm / 4.8 x 16 mm

Bijzonderheden:
* = uitsluitend leverbaar in tubeverpakkin3

Voorboren
ø 3,0 mm

7612 BARRIÈRESTANG V1

Toepassing
voor klepramen

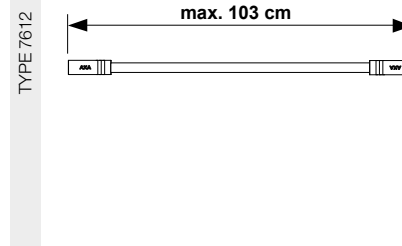

Productpositie

Klepraam

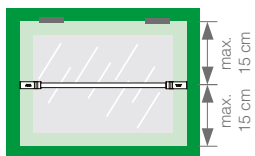

Benodigde montageruimte

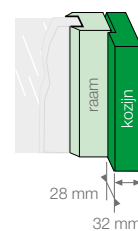

Toepasbare draairichting

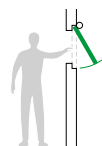

Artikelnummer	Materiaal/kleur/finish	Klein-verpakking	Groot-verpakking	Minimaal bestelaantal	Aanbevolen bevestiging
7612-10-54/BL*	staal wit	1	6	1	-
7612-10-81/BL*	RVS	1	6	1	-

Bijzonderheden:
* = uitsluitend leverbaar in tubeverpakking

BARRIÈRESTANG V2 7614

Toepassing
voor klepramen

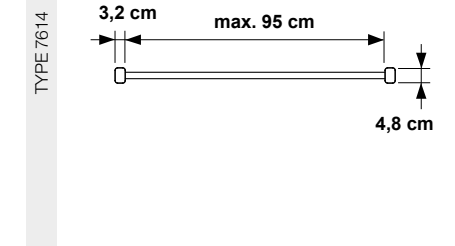

Productpositie

Klepraam

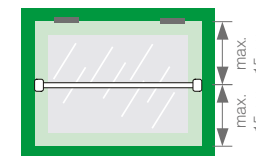

Benodigde montageruimte

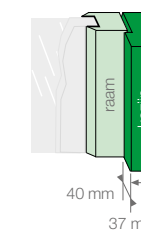

Toepasbare draairichting

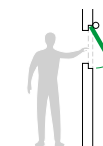

Artikelnummer	Materiaal/kleur/finish	Klein-verpakking	Groot-verpakking	Minimaal bestelaantal	Aanbevolen bevestiging
7614-95-54/BL*	staal wit	1	6	1	5.0 x 60 mm
7614-95-81/BL*	RVS	1	6	1	5.0 x 60 mm

Bijzonderheden:
* = uitsluitend leverbaar in tubeverpakking

Voorboren
ø 3,0 mm

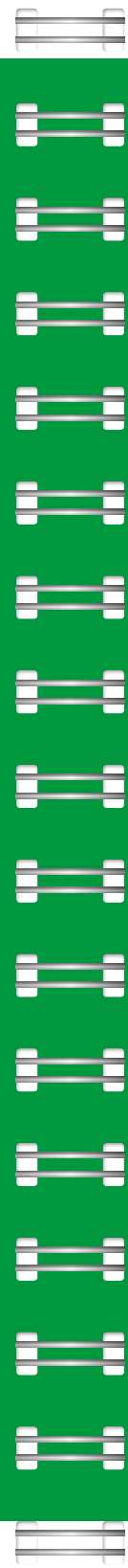

ASSA Toegangs- management



INDEX VERPAKKINGEN ASSA RAAMPRODUCTEN DEURPRODUCTEN DEURCILINDERS DEURSLOTEN DEURBESLAG RAAMSLUITINGEN UITZETTERS SCHARNIEREN

ASSA TOEGANGSMANAGEMENT

ASSA levert onder de naam ASSA toegangsmanagement totaal oplossingen voor sleutelsystemen, toegangscontrole en sleutelmanagement

Samen met onze opdrachtgevers en partners biedt ASSA innovatieve oplossingen voor sleutelsystemen, toegangscontrole en sleutelmanagement voor gebouwen en objecten. Hiermee garanderen wij optimale veiligheid, kwaliteit en gebruiksgemak en dragen zij bij aan het rendement van onze opdrachtgevers.

Als exclusief vertegenwoordiger binnen de Benelux van de merken ASSA en Ruko, is onze afdeling Toegangsmanagement bij uitstek geschikt u een totaaloplossing voor uw bedrijfspanden te leveren.

ASSA is de Zweedse fabrikant van sloten, beslag en (brandweer) cilinder-sluitsystemen, waarbij veiligheid, functionaliteit en betrouwbaarheid de belangrijkste pijlers zijn. Onze producten voldoen aan de Nederlandse SKG veiligheidskeurmerken en NEN normeringen.

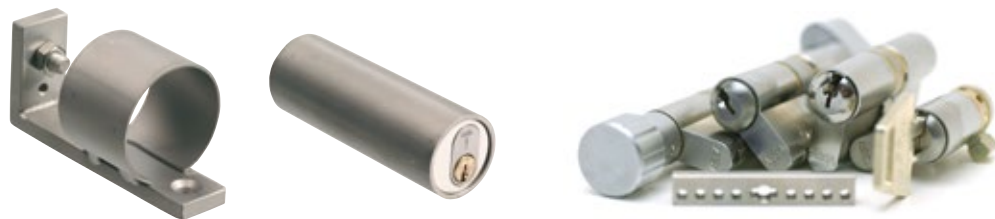

AXA Stenman Nederland B.V. levert ook een uitgebreid assortiment deursloten en deurbeslag van ASSA en RUKO, het Deense zusterbedrijf van ASSA.

Om een totale beveiligingsoplossing te kunnen bieden hebben wij het merk CREONE, leverancier van hoogwaardige sleutelbeheer systemen. Flexibiliteit is het kenmerk van onze sleutelkasten. U bent daarbij niet gebonden aan één systeem, maar kunt de manier van opbergen aanpassen aan uw situatie. De uitbreidingskasten en de flexibele sleutelstrips vormen de basis voor deze aanpassingsmogelijkheden.



ASSA TOEGANGSMANAGEMENT

Door onze jarenlange ervaring en uitgebreide kennis kunnen wij u op professionele wijze de juiste oplossing aandragen. Wij staan voor maatwerk, kwaliteit en snelle levering.

Met name in kantoren, zorginstellingen (oa ziekenhuizen), overheidsgebouwen, scholen en gebouwen, waar ondanks intensief gebruik, veiligheid en duurzaamheid een must is, bewijzen onze producten zich iedere dag.

Nieuwe generatie elektronische sluitsystemen en toegangscontrole

Tot voor een paar jaar terug kon u kiezen uit een mechanisch sluitsysteem of een volledig bekabeld toegangscontrolesysteem.

ASSA biedt met de nieuwe generatie elektronische sluitsystemen (DP Cliq) en nieuwe toegangscontrolesystemen (RX/ARX), efficiënte oplossingen die tussen de mechanische cilinder en de bekabelde toegangscontrole zitten.



Deze slimme sluitsystemen kenmerken zich door programmeerbare oplossingen, waar geen of nauwelijks bekabeling voor nodig is. Om wijzigingen door te geven maken zij gebruik van programmeerbare passen en sleutels. De gebruikte software kan geïntegreerd worden in een bestaand netwerk dat gebruik maakt van internet. Elektronische sluitsystemen en toegangscontrole bieden de juiste oplossingen en kunnen meegroeien met uw organisatie.

Meer informatie?

Voor meer informatie kunt u contact opnemen met onze afdeling ASSA Toegangsmanagement **0318-536111**, mail: assa@axahomesecurity.com. Zij vertellen u er graag meer over.



Consumenten- verpakkingen

Inhoudsopgave	Pagina
Scharnieren	342
Raamuitzetters	343
Combi-raamuitzetters	343
Telescopische uitzetters	344
AXA Remote	345
Oplegsloten	345
Dievenklauwen	346
Raamsluitingen	346
Deurkrukken	348
Binnendeurschilden	349
Veiligheidsbeslag	350
Binnendeursloten	356
Cilinders	357
Veiligheidscilinders	358
Inboorgrendels	359
Kierstandhouders	359
Veiligheidsdeursloten	359
Barrièrestangen	360
Deurbeveiligingsstrips	360
Deurspionnen	361

SCHARNIEREN

Voorbeeld	Artikelnummer	Type	Bliester-formaat in mm	Product(en) per blister	Groot-verpakking	Info-pagina
	1113-24-23/BL3	Ongelagerd scharnier, 76 x 76	215 x 95 x 47	3	8	24
	1113-24-23/BLV3	Ongelagerd veiligheids-scharnier, 76 x 76	215 x 95 x 47	3	8	24
	1113-24-23/BLV8	Ongelagerd veiligheids-scharnier, 76 x 76	275 x 134 x 50	8	8	24
	1113-25-23/BLV2	Ongelagerd veiligheids-scharnier, 89 x 89	215 x 95 x 47	2	8	25
	1113-25-23/BLV3	Ongelagerd veiligheids-scharnier, 89 x 89	215 x 95 x 47	3	8	25
	1139-25-23/BLV2	Venelite veiligheidsscharnier, 89 x 89	215 x 95 x 47	2	8	36
	1139-25-23/BLV3	Venelite veiligheidsscharnier, 89 x 89	215 x 95 x 47	3	8	36
	1177-10-37/BL	Inboorpaumelle	215 x 95 x 47	2	8	37
	1531-24-23/BL2	Kogellager scharnier, 76 x 76	215 x 95 x 47	2	8	56
	1531-24-23/BL3	Kogellager scharnier, 76 x 76	215 x 95 x 47	3	8	56
	1531-25-23/BL2	Kogellager scharnier, 89 x 89	215 x 95 x 47	2	8	57
	1531-25-23/BL3	Kogellager scharnier, 89 x 89	215 x 95 x 47	3	8	57
	1541-24-23/BLV2	Veiligheids kogellager scharnier 76 x 76	215 x 95 x 47	2	8	61
	1541-24-23/BLV3	Veiligheids kogellager scharnier 76 x 76	215 x 95 x 47	3	8	61
	1541-25-23/BLV2	Veiligheids kogellager scharnier 89 x 89	215 x 95 x 47	2	8	62
	1541-25-23/BLV3	Veiligheids kogellager scharnier 89 x 89	215 x 95 x 47	3	8	62
	1541-25-81/BLV2	Veiligheids kogellager scharnier 89 x 89	215 x 95 x 47	2	8	62
	1541-25-81/BLV3	Veiligheids kogellager scharnier 89 x 89	215 x 95 x 47	3	8	62
	1543-24-23/BLV2	Veiligheids kogellager scharnier 76 x 76	215 x 95 x 47	2	8	63
	1543-24-23/BLV3	Veiligheids kogellager scharnier 76 x 76	215 x 95 x 47	3	8	63
1543-25-23/BLV2	Veiligheids kogellager scharnier 89 x 89	215 x 95 x 47	2	8	64	
1543-25-23/BLV3	Veiligheids kogellager scharnier 89 x 89	215 x 95 x 47	3	8	64	

- 08 = Messing vernikkeld
- 11 = Aluminium geslepen F1
- 22 = Staal galvanisch verzinkt
- 23 = Topcoat gegalvaniseerd staal
- 29 = Aluminium geslepen Inox
- 32 = Aluminium Satin Inox
- 37 = Staal vernikkeld
- 44 = Staal bruin
- 49 = Staal grijs
- 54 = Staal wit
- 62 = Messing mat vernikkeld
- 64 = Zamac galvanisch verzinkt



SCHARNIEREN - RAAMUITZETTERS

Voorbeeld	Artikelnummer	Type	Bliester-formaat in mm	Product(en) per blister	Groot-verpakking	Info-pagina
	1543-25-81/BLV2	Veiligheids kogellager scharnier 89 x 89	215 x 95 x 47	2	8	64
	1543-25-81/BLV3	Veiligheids kogellager scharnier 89 x 89	215 x 95 x 47	3	8	64
	1647-09-81/BLV2	Smart veiligheids schijflager-scharnier 89 x 89	215 x 95 x 47	2	8	71
	1647-09-81/BLV3	Smart veiligheids schijflager-scharnier 89 x 89	215 x 95 x 47	3	8	71
	1677-09-23/BL2	Smart Easyfix scharnier 89 x 89	215 x 95 x 47	2	8	75
	1677-09-23/BL3	Smart Easyfix scharnier 89 x 89	215 x 95 x 47	3	8	75
	1687-09-23/BLV2	Smart Easyfix veiligheids scharnier 89 x 89	215 x 95 x 47	2	8	77
	1687-09-23/BLV3	Smart Easyfix veiligheids scharnier 89 x 89	215 x 95 x 47	3	8	77

Voorbeeld	Artikelnummer	Type	Bliester-formaat in mm	Product(en) per blister	Groot-verpakking	Info-pagina
	2465-06-22/BL	Uitzetterpen Habilis HL	90 x 95 x 25	1	12	121
	2465-06-81/BL	Uitzetterpen Habilis HL	90 x 95 x 25	1	12	121
	2466-06-22/BL	Uitzetterpen Elite EL	90 x 95 x 25	1	12	124

Voorbeeld	Artikelnummer	Type	Bliester-formaat in mm	Product(en) per blister	Groot-verpakking	Info-pagina
	2609-30-49/BL	Raamuitzetter Elite	415 x 95 x 35	1	8	122
	2609-30-81/BL	Raamuitzetter Elite	415 x 95 x 35	1	8	122
	2635-30-49/BL	Raamuitzetter Hablis	415 x 95 x 35	1	8	118
	2635-30-81/BL	Raamuitzetter Hablis	415 x 95 x 35	1	8	118
	2636-30-74/BL	Raamuitzetter Hablis	415 x 95 x 35	1	8	118

- 68 = Zamac wit
- 74 = Roestvaststaal wit
- 75 = Roestvaststaal grijs
- 81 = Roestvaststaal
- 88 = Aluminium wit
- 90 = Kunststof grijs
- 91 = Aluminium geanodiseerd F1
- 92 = Aluminium geanodiseerd F2
- 97 = Kunststof antraciet
- 98 = Kunststof wit
- 99 = Kunststof aluminium
- V = Veiligheidsuitvoering

COMBI-RAAMUITZETTERS - TELESCOPISCHE UITZETTERS

Voorbeeld	Artikelnummer	Type	Bliester-formaat in mm	Product(en) per blister	Groot-verpakking	Info-pagina
	2640-20-44/BL	Combi-raamuitzetter AXAflex	275 x 95 x 42	1	8	104
	2640-20-49/BL	Combi-raamuitzetter AXAflex	275 x 95 x 42	1	8	104
	2640-20-81/BL	Combi-raamuitzetter AXAflex	275 x 95 x 42	1	8	104
	2660-20-74/BL	Combi-raamuitzetter AXAflex	275 x 95 x 42	1	8	104

Voorbeeld	Artikelnummer	Type	Bliester-formaat in mm	Product(en) per blister	Groot-verpakking	Info-pagina
	2660-20-74/BL	Combi-raamuitzetter AXAflex Security	275 x 95 x 53	1	8	102
	2660-20-75/BL	Combi-raamuitzetter AXAflex Security	275 x 95 x 53	1	8	102
	2660-20-81/BL	Combi-raamuitzetter AXAflex Security	275 x 95 x 53	1	8	102

Voorbeeld	Artikelnummer	Type	Bliester-formaat in mm	Product(en) per blister	Groot-verpakking	Info-pagina
	2815-00-49/BL	Telescopische uitzetter 20EX	275 x 95 x 47	1	8	125
	2815-00-54/BL	Telescopische uitzetter 20EX	275 x 95 x 47	1	8	125
	2815-00-81/BL	Telescopische uitzetter 20EX	275 x 95 x 47	1	8	125
	2825-00-49/BL	Telescopische uitzetter 30EX	275 x 95 x 47	1	8	126
	2825-00-54/BL	Telescopische uitzetter 30EX	275 x 95 x 47	1	8	126
	2825-00-81/BL	Telescopische uitzetter 30EX	275 x 95 x 47	1	8	126
	2835-00-49/BL	Telescopische uitzetter 35EX	275 x 95 x 47	1	8	128
	2835-00-54/BL	Telescopische uitzetter 35EX	275 x 95 x 47	1	8	128

Voorbeeld	Artikelnummer	Type	Bliester-formaat in mm	Product(en) per blister	Groot-verpakking	Info-pagina
	2826-00-49/BL	Telescopische uitzetter 30IN	275 x 95 x 47	1	8	132
	2826-00-54/BL	Telescopische uitzetter 30IN	275 x 95 x 47	1	8	132

- | | | |
|-----------------------------------|------------------------------|--------------------------------|
| 08 = Messing vernikkeld | 29 = Aluminium geslepen Inox | 49 = Staal grijs |
| 11 = Aluminium geslepen F1 | 32 = Aluminium Satin Inox | 54 = Staal wit |
| 22 = Staal galvanisch verzinkt | 37 = Staal vernikkeld | 62 = Messing mat vernikkeld |
| 23 = Topcoat gegalvaniseerd staal | 44 = Staal bruin | 64 = Zamac galvanisch verzinkt |



AXA REMOTE - OPLEGLOTEN

Voorbeeld	Artikelnummer	Type	Bliester-formaat in mm	Product(en) per blister	Groot-verpakking	Info-pagina
	2902-00-96/BL	Raamopener met afstandsbediening AXA Remote klepraam	380 x 187 x 50	1	3	94
	2902-00-98/BL	Raamopener met afstandsbediening AXA Remote klepraam	380 x 187 x 50	1	3	94
	2902-00-99/BL	Raamopener met afstandsbediening AXA Remote klepraam	380 x 187 x 50	1	3	95
	2902-36-98/BL	Raamopener met afstandsbediening AXA Remote dakraam	380 x 187 x 50	1	3	100
	2902-80-98/BL	Wandbedieningsknop AXA Remote	225 x 175 x 90	1	2	101

Voorbeeld	Artikelnummer	Type	Bliester-formaat in mm	Product(en) per blister	Groot-verpakking	Info-pagina
	3011-00-68/BL	Oplegslot 3011	155 x 95 x 37	1	12	173
	3012-20-90/BL	Oplegslot 3012	155 x 95 x 47	1	12	174
	3012-20-90/BL2	Oplegslot 3012	155 x 95 x 47	2	12	174
	3012-20-97/BL	Oplegslot 3012	155 x 95 x 47	1	12	174
	3012-20-98/BL	Oplegslot 3012	155 x 95 x 47	1	12	174
	3012-20-98/BL2	Oplegslot 3012	155 x 95 x 47	2	12	174
	3015-20-90/BL	Oplegslot 3015	155 x 95 x 60	1	12	175
	3015-20-98/BL	Oplegslot 3015	155 x 95 x 60	1	12	175
	3016-00-90/BL	Oplegslot 3016	155 x 95 x 47	1	12	176
	3016-00-98/BL	Oplegslot 3016	155 x 95 x 47	1	12	176

Voorbeeld	Artikelnummer	Type	Bliester-formaat in mm	Product(en) per blister	Groot-verpakking	Info-pagina
	3013-20-44/BLF	Oplegslot 3013	275 x 95 x 37	1	6	N.v.t.
	3013-20-90/BLF	Oplegslot 3013	275 x 95 x 37	1	6	N.v.t.
	3013-20-98/BLF	Oplegslot 3013	275 x 95 x 37	1	6	N.v.t.
	3017-20-44/BLF	Oplegslot 3017	275 x 95 x 37	1	6	N.v.t.
	3017-20-98/BLF	Oplegslot 3017	275 x 95 x 37	1	6	N.v.t.
	3018-20-44/BLF	Oplegslot 3018	215 x 95 x 37	1	6	N.v.t.
	3018-20-98/BLF	Oplegslot 3018	215 x 95 x 37	1	6	N.v.t.

- | | | |
|---------------------------|--------------------------------|---------------------------|
| 68 = Zamac wit | 88 = Aluminium wit | 97 = Kunststof antraciet |
| 74 = Roestvaststaal wit | 90 = Kunststof grijs | 98 = Kunststof wit |
| 75 = Roestvaststaal grijs | 91 = Aluminium geanodiseerd F1 | 99 = Kunststof aluminium |
| 81 = Roestvaststaal | 92 = Aluminium geanodiseerd F2 | V = Veiligheidsuitvoering |

DIEVENKLAUWEN - RAAMSLUITINGEN

RAAMSLUITINGEN

Voorbeeld	Artikelnummer	Type	Bliester-formaat in mm	Product(en) per blister	Groot-verpakking	Info-pagina
	3113-03-22/BL2	Dievenkluwen	155 x 95 x 27	2	8	88
	3113-03-22/BL3	Dievenkluwen	155 x 95 x 27	3	8	88
	3113-03-22/BL12	Dievenkluwen	215 x 95 x 47	12	8	88

Voorbeeld	Artikelnummer	Type	Bliester-formaat in mm	Product(en) per blister	Groot-verpakking	Info-pagina
	3302-31-11/BL	Raamsluiting 3302	215 x 95 x 48	1	8	142
	3302-31-29/BL	Raamsluiting 3302	215 x 95 x 48	1	8	142
	3302-31-68/BL	Raamsluiting 3302	215 x 95 x 48	1	8	142
	3302-31-91/BL	Raamsluiting 3302	215 x 95 x 48	1	8	142
	3302-31-92/BL	Raamsluiting 3302	215 x 95 x 48	1	8	142
	3302-41-11/BL	Raamsluiting 3302	215 x 95 x 48	1	8	143
	3302-41-29/BL	Raamsluiting 3302	215 x 95 x 48	1	8	143
	3302-41-68/BL	Raamsluiting 3302	215 x 95 x 48	1	8	143
	3302-41-91/BL	Raamsluiting 3302	215 x 95 x 48	1	8	143
	3302-41-92/BL	Raamsluiting 3302	215 x 95 x 48	1	8	143

Voorbeeld	Artikelnummer	Type	Bliester-formaat in mm	Product(en) per blister	Groot-verpakking	Info-pagina
	3308-31-11/BL	Raamsluiting 3308	215 x 95 x 48	1	8	146
	3308-31-32/BL	Raamsluiting 3308	215 x 95 x 48	1	8	146
	3308-31-68/BL	Raamsluiting 3308	215 x 95 x 48	1	8	146
	3308-31-91/BL	Raamsluiting 3308	215 x 95 x 48	1	8	146
	3308-31-92/BL	Raamsluiting 3308	215 x 95 x 48	1	8	146
	3308-41-11/BL	Raamsluiting 3308	215 x 95 x 48	1	8	147
	3308-41-32/BL	Raamsluiting 3308	215 x 95 x 48	1	8	147
	3308-41-68/BL	Raamsluiting 3308	215 x 95 x 48	1	8	147
	3308-41-91/BL	Raamsluiting 3308	215 x 95 x 48	1	8	147
	3308-41-92/BL	Raamsluiting 3308	215 x 95 x 48	1	8	147

Voorbeeld	Artikelnummer	Type	Bliester-formaat in mm	Product(en) per blister	Groot-verpakking	Info-pagina
	3309-31-91/BL	Raamsluiting 3309	215 x 95 x 48	1	8	148
	3309-31-92/BL	Raamsluiting 3309	215 x 95 x 48	1	8	148
	3309-41-91/BL	Raamsluiting 3309	215 x 95 x 48	1	8	149
	3309-41-92/BL	Raamsluiting 3309	215 x 95 x 48	1	8	149

- | | | |
|-----------------------------------|------------------------------|--------------------------------|
| 08 = Messing vernikkeld | 29 = Aluminium geslepen Inox | 49 = Staal grijs |
| 11 = Aluminium geslepen F1 | 32 = Aluminium Satin Inox | 54 = Staal wit |
| 22 = Staal galvanisch verzinkt | 37 = Staal vernikkeld | 62 = Messing mat vernikkeld |
| 23 = Topcoat gegalvaniseerd staal | 44 = Staal bruin | 64 = Zamac galvanisch verzinkt |



146

Voorbeeld	Artikelnummer	Type	Bliester-formaat in mm	Product(en) per blister	Groot-verpakking	Info-pagina
	3318-51-91/BL	Raamsluiting 3318	215 x 95 x 48	1	8	152
	3318-51-92/BL	Raamsluiting 3318	215 x 95 x 48	1	8	152
	3318-61-91/BL	Raamsluiting 3318	215 x 95 x 48	1	8	153
	3318-61-92/BL	Raamsluiting 3318	215 x 95 x 48	1	8	153

Voorbeeld	Artikelnummer	Type	Bliester-formaat in mm	Product(en) per blister	Groot-verpakking	Info-pagina
	3319-51-11/BL	Veiligheids raamsluiting 3319	215 x 95 x 63	1	8	156
	3319-51-29/BL	Veiligheids raamsluiting 3319	215 x 95 x 63	1	8	156
	3319-51-32/BL	Veiligheids raamsluiting 3319	215 x 95 x 63	1	8	156
	3319-51-91/BL	Veiligheids raamsluiting 3319	215 x 95 x 63	1	8	156
	3319-51-92/BL	Veiligheids raamsluiting 3319	215 x 95 x 63	1	8	156
	3319-61-11/BL	Veiligheids raamsluiting 3319	215 x 95 x 63	1	8	156
	3319-61-29/BL	Veiligheids raamsluiting 3319	215 x 95 x 63	1	8	156
	3319-61-32/BL	Veiligheids raamsluiting 3319	215 x 95 x 63	1	8	156
	3319-61-91/BL	Veiligheids raamsluiting 3319	215 x 95 x 63	1	8	156
	3319-61-92/BL	Veiligheids raamsluiting 3319	215 x 95 x 63	1	8	156

Voorbeeld	Artikelnummer	Type	Bliester-formaat in mm	Product(en) per blister	Groot-verpakking	Info-pagina
	3320-51-11/BL	Veiligheids raamsluiting 3320	215 x 95 x 63	1	8	164
	3320-51-29/BL	Veiligheids raamsluiting 3320	215 x 95 x 63	1	8	164
	3320-51-91/BL	Veiligheids raamsluiting 3320	215 x 95 x 63	1	8	164
	3320-51-92/BL	Veiligheids raamsluiting 3320	215 x 95 x 63	1	8	164
	3320-61-11/BL	Veiligheids raamsluiting 3320	215 x 95 x 63	1	8	165
	3320-61-29/BL	Veiligheids raamsluiting 3320	215 x 95 x 63	1	8	165
	3320-61-91/BL	Veiligheids raamsluiting 3320	215 x 95 x 63	1	8	165
	3320-61-92/BL	Veiligheids raamsluiting 3320	215 x 95 x 63	1	8	165

Voorbeeld	Artikelnummer	Type	Bliester-formaat in mm	Product(en) per blister	Groot-verpakking	Info-pagina
	3329-51-91/BL	Veiligheids raamsluiting 3329	215 x 95 x 55	1	8	170
	3329-61-91/BL	Veiligheids raamsluiting 3329	215 x 95 x 55	1	8	170

- | | | |
|---------------------------|--------------------------------|---------------------------|
| 68 = Zamac wit | 88 = Aluminium wit | 97 = Kunststof antraciet |
| 74 = Roestvaststaal wit | 90 = Kunststof grijs | 98 = Kunststof wit |
| 75 = Roestvaststaal grijs | 91 = Aluminium geanodiseerd F1 | 99 = Kunststof aluminium |
| 81 = Roestvaststaal | 92 = Aluminium geanodiseerd F2 | V = Veiligheidsuitvoering |

RAAMSLUITINGEN - DEURKRUKKEN

Voorbeeld	Artikelnummer	Type	Bliester-formaat in mm	Product(en) per blister	Groot-verpakking	Info-pagina
	3350-10-29/BL	Veiligheids draai-kiep raamkruk L	215 x 95 x 37	1	8	172
	3350-10-88/BL	Veiligheids draai-kiep raamkruk L	215 x 95 x 37	1	8	172
	3350-10-91/BL	Veiligheids draai-kiep raamkruk L	215 x 95 x 37	1	8	172

Voorbeeld	Artikelnummer	Type	Bliester-formaat in mm	Product(en) per blister	Groot-verpakking	Info-pagina
	3355-15-81/LBL	Veiligheids combi-raamsluiting Oyster	215 x 95 x 41	1	6	138
	3355-15-81/LBR	Veiligheids combi-raamsluiting Oyster	215 x 95 x 41	1	6	138

Voorbeeld	Artikelnummer	Type	Bliester-formaat in mm	Product(en) per blister	Groot-verpakking	Info-pagina
	3303-92-23/BL	Sluithaak SH	155 x 95 x 37	1	12	180
	3303-93-23/BL	Sluithaak SHK	155 x 95 x 37	1	12	180
	3305-60-95/BL	Onderlegplaat raamsluiting	155 x 95 x 37	1	8	180
	3305-90-95/BL	Onderlegplaat raamsluiting	155 x 95 x 37	1	8	180
	3307-85-64/BL	Sluitkom A	155 x 95 x 37	1	8	180
	3307-85-68/BL	Sluitkom A	155 x 95 x 37	1	8	180
	3307-87-64/BL	Sluitkom N	155 x 95 x 37	1	8	180

Voorbeeld	Artikelnummer	Type	Bliester-formaat in mm	Product(en) per blister	Groot-verpakking	Info-pagina
	6140-71-11/BL	Deurkruk L	275 x 95 x 44	1	8	235
	6141-71-11/BL	Deurkruk U	275 x 95 x 44	1	8	236
	6142-71-11/BL	Deurkruk C	275 x 95 x 44	1	8	237
	6150-71-11/BL	Deurkruk Curve	275 x 95 x 44	1	8	238
	6164-71-11/BL	Deurkruk Blok zwaar	275 x 95 x 44	1	8	239
	6164-71-91/BL	Deurkruk Blok zwaar	275 x 95 x 44	1	8	239
	6171-71-11/BL	Deurkruk Sabel	275 x 95 x 44	1	8	240
6171-71-91/BL	Deurkruk Sabel	275 x 95 x 44	1	8	240	

Voorbeeld	Artikelnummer	Type	Bliester-formaat in mm	Product(en) per blister	Groot-verpakking	Info-pagina
	6051-00-22/BL	Renovatieset binnenschild	155 x 95 x 27	1	8	N.v.t.

- | | | |
|-----------------------------------|------------------------------|--------------------------------|
| 08 = Messing vernikkeld | 29 = Aluminium geslepen Inox | 49 = Staal grijs |
| 11 = Aluminium geslepen F1 | 32 = Aluminium Satin Inox | 54 = Staal wit |
| 22 = Staal galvanisch verzinkt | 37 = Staal vernikkeld | 62 = Messing mat vernikkeld |
| 23 = Topcoat gegalvaniseerd staal | 44 = Staal bruin | 64 = Zamac galvanisch verzinkt |



DEURKRUKKEN - BINNENDEURSCHILDEN

Voorbeeld	Artikelnummer	Type	Bliester-formaat in mm	Product(en) per blister	Groot-verpakking	Info-pagina
	6154-10-91/BL	Deurkruk Blok	190 x 195 x 32	1	8	242
	6155-07-91/BL	Deurkruk Vlinder	190 x 195 x 32	1	8	243
	6170-10-91/BL	Deurkruk Duim	190 x 195 x 32	1	8	244

Voorbeeld	Artikelnummer	Type	Bliester-formaat in mm	Product(en) per blister	Groot-verpakking	Info-pagina
	6206-00-11/BL	Briefplaat met naamplaat	340 x 95 x 32	1	8	268

Voorbeeld	Artikelnummer	Type	Bliester-formaat in mm	Product(en) per blister	Groot-verpakking	Info-pagina
	6210-20-11/BL55	Curve Klik Binnendeurschilden PC55	275 x 95 x 25	1	10	246
	6210-20-11/BL72	Curve Klik Binnendeurschilden PC72	275 x 95 x 25	1	10	246
	6210-30-11/BL55	Curve Klik Binnendeurschilden SL55	275 x 95 x 25	1	10	247
	6210-30-11/BL72	Curve Klik Binnendeurschilden SL72	275 x 95 x 25	1	10	247
	6210-48-11/BL63	Curve Klik Toiletdeurschilden TL63/8	275 x 95 x 55	1	6	248
	6210-50-11/BL	Curve Klik Loopdeurschilden	275 x 95 x 25	1	10	249

Voorbeeld	Artikelnummer	Type	Bliester-formaat in mm	Product(en) per blister	Groot-verpakking	Info-pagina
	6210-90-11/BL	Curve Klik Binnendeurozetten kruk recht	155 x 95 x 27	1	8	252
	6220-10-11/BL	Curve Klik Binnendeurozetten kruk rond	155 x 95 x 36	1	8	253
	6220-20-11/BL	Curve Klik Binnendeurozetten SL rond	155 x 95 x 36	1	8	254
	6220-30-11/BL	Curve Klik Binnendeurozetten PC rond	155 x 95 x 36	1	8	255
	6220-40-11/BL	Curve Klik Binnendeurozetten TL rond	155 x 95 x 55	1	8	256

- | | | |
|---------------------------|--------------------------------|---------------------------|
| 68 = Zamac wit | 88 = Aluminium wit | 97 = Kunststof antraciet |
| 74 = Roestvaststaal wit | 90 = Kunststof grijs | 98 = Kunststof wit |
| 75 = Roestvaststaal grijs | 91 = Aluminium geanodiseerd F1 | 99 = Kunststof aluminium |
| 81 = Roestvaststaal | 92 = Aluminium geanodiseerd F2 | V = Veiligheidsuitvoering |

BINNENDEURSCHILDEN - VEILIGHEIDSBESLAG

Voorbeeld	Artikelnummer	Type	Bliester-formaat in mm	Product(en) per blister	Groot-verpakking	Info-pagina
	6350-20-91/BL55	Curve Binnendeurschilden PC55	275 x 95 x 21	1	10	258
	6350-20-91/BL72	Curve Binnendeurschilden PC55	275 x 95 x 21	1	10	258
	6350-30-91/BL55	Curve Binnendeurschilden SL55	275 x 95 x 21	1	10	259
	6350-30-91/BL72	Curve Binnendeurschilden SL55	275 x 95 x 21	1	10	259
	6350-48-91/BL63	Curve Toiletdeurschilden TL63	275 x 95 x 55	1	8	260
	6350-50-91/BL	Curve Loopdeurschilden	275 x 95 x 21	1	10	261

Voorbeeld	Artikelnummer	Type	Bliester-formaat in mm	Product(en) per blister	Groot-verpakking	Info-pagina
	6350-90-91/BL	Curve Binnendeurozetten kruk	155 x 95 x 21	1	8	264
	6350-91-91/BL	Curve Binnendeurozetten SL	155 x 95 x 21	1	8	265
	6350-92-91/BL	Curve Binnendeurozetten PC	155 x 95 x 21	1	8	266

Voorbeeld	Artikelnummer	Type	Bliester-formaat in mm	Product(en) per blister	Groot-verpakking	Info-pagina
	6635-34-32/BL55	Duwer Veiligheidsbeslag PC55 anti-kerntrek	380 x 187 x 60	1	2	N.v.t.
	6635-34-32/BL72	Duwer Veiligheidsbeslag PC72 anti-kerntrek	380 x 187 x 60	1	2	N.v.t.

- 08 = Messing vernikkeld
- 11 = Aluminium geslepen F1
- 22 = Staal galvanisch verzinkt
- 23 = Topcoat gegalvaniseerd staal

- 29 = Aluminium geslepen Inox
- 32 = Aluminium Satin Inox
- 37 = Staal vernikkeld
- 44 = Staal bruin

- 49 = Staal grijs
- 54 = Staal wit
- 62 = Messing mat vernikkeld
- 64 = Zamac galvanisch verzinkt

VEILIGHEIDSBESLAG

Voorbeeld	Artikelnummer	Type	Bliester-formaat in mm	Product(en) per blister	Groot-verpakking	Info-pagina
	6665-35-11/BL55	Curve D-Duwer Veiligheidsbeslag PC55 anti-kerntrek	340 x 187 x 60	1	2	203
	6665-35-11/BL72	Curve D-Duwer Veiligheidsbeslag PC72 anti-kerntrek	340 x 187 x 60	1	2	203

Voorbeeld	Artikelnummer	Type	Bliester-formaat in mm	Product(en) per blister	Groot-verpakking	Info-pagina
	6765-35-11/BL55	Curve Smal D-Duwer Veiligheidsbeslag PC55 anti-kerntrek	340 x 187 x 60	1	2	208
	6765-35-11/BL72	Curve Smal D-Duwer Veiligheidsbeslag PC72 anti-kerntrek	340 x 187 x 60	1	2	208
	6765-35-11/BLF92	Curve Smal D-Duwer Veiligheidsbeslag PC92 anti-kerntrek	340 x 187 x 60	1	2	208

Voorbeeld	Artikelnummer	Type	Bliester-formaat in mm	Product(en) per blister	Groot-verpakking	Info-pagina
	6660-30-11/BL55	Curve Duwer Veiligheidsbeslag PC55	340 x 187 x 60	1	2	217
	6660-30-11/BL72	Curve Duwer Veiligheidsbeslag PC72	340 x 187 x 60	1	2	217

- 68 = Zamac wit
- 74 = Roestvaststaal wit
- 75 = Roestvaststaal grijs
- 81 = Roestvaststaal

- 88 = Aluminium wit
- 90 = Kunststof grijs
- 91 = Aluminium geanodiseerd F1
- 92 = Aluminium geanodiseerd F2

- 97 = Kunststof antraciet
- 98 = Kunststof wit
- 99 = Kunststof aluminium
- V = Veiligheidsuitvoering

VEILIGHEIDSBESLAG

Voorbeeld	Artikelnummer	Type	Bliester-formaat in mm	Product(en) per blister	Groot-verpakking	Info-pagina
	6660-51-11/BL55	Curve S-Knop Veiligheidsbeslag PC55	340 x 187 x 60	1	2	204
	6660-51-11/BL72	Curve S-Knop Veiligheidsbeslag PC72	340 x 187 x 60	1	2	204

Voorbeeld	Artikelnummer	Type	Bliester-formaat in mm	Product(en) per blister	Groot-verpakking	Info-pagina
	6675-51-29/BL55	Curve S-Knop Veiligheidsbeslag PC55 anti-kerntrek	340 x 187 x 60	1	2	206
	6675-51-29/BL72	Curve S-Knop Veiligheidsbeslag PC72 anti-kerntrek	340 x 187 x 60	1	2	206

Voorbeeld	Artikelnummer	Type	Bliester-formaat in mm	Product(en) per blister	Groot-verpakking	Info-pagina
	6670-51-11/BL55	Curve S-Knop Veiligheidsbeslag PC55	340 x 187 x 60	1	2	N.v.t.
	6670-51-11/BL72	Curve S-Knop Veiligheidsbeslag PC72	340 x 187 x 60	1	2	N.v.t.

Voorbeeld	Artikelnummer	Type	Bliester-formaat in mm	Product(en) per blister	Groot-verpakking	Info-pagina
	6615-60-32/BL	Knop+PC Veiligheidsrozetten rond anti-kerntrek	275 x 187 x 60	1	2	N.v.t.

- | | | |
|-----------------------------------|------------------------------|--------------------------------|
| 08 = Messing vernikkeld | 29 = Aluminium geslepen Inox | 49 = Staal grijs |
| 11 = Aluminium geslepen F1 | 32 = Aluminium Satin Inox | 54 = Staal wit |
| 22 = Staal galvanisch verzinkt | 37 = Staal vernikkeld | 62 = Messing mat vernikkeld |
| 23 = Topcoat gegalvaniseerd staal | 44 = Staal bruin | 64 = Zamac galvanisch verzinkt |



VEILIGHEIDSBESLAG

Voorbeeld	Artikelnummer	Type	Bliester-formaat in mm	Product(en) per blister	Groot-verpakking	Info-pagina
	6660-60-11/BL55	Curve Knop Veiligheidsbeslag PC55	340 x 187 x 60	1	2	N.v.t.
	6660-60-11/BL72	Curve Knop Veiligheidsbeslag PC72	340 x 187 x 60	1	2	N.v.t.

Voorbeeld	Artikelnummer	Type	Bliester-formaat in mm	Product(en) per blister	Groot-verpakking	Info-pagina
	6615-10-32/BL	Kruk+PC Veiligheidsrozetten rond anti-kerntrek	275 x 187 x 60	1	4	N.v.t.

Voorbeeld	Artikelnummer	Type	Bliester-formaat in mm	Product(en) per blister	Groot-verpakking	Info-pagina
	6635-10-32/BL55	Kruk Veiligheidsbeslag PC55 anti-kerntrek	380 x 187 x 30	1	3	N.v.t.
	6635-10-32/BL72	Kruk Veiligheidsbeslag PC72 anti-kerntrek	380 x 187 x 30	1	3	N.v.t.

- | | | |
|---------------------------|--------------------------------|---------------------------|
| 68 = Zamac wit | 88 = Aluminium wit | 97 = Kunststof antraciet |
| 74 = Roestvaststaal wit | 90 = Kunststof grijs | 98 = Kunststof wit |
| 75 = Roestvaststaal grijs | 91 = Aluminium geanodiseerd F1 | 99 = Kunststof aluminium |
| 81 = Roestvaststaal | 92 = Aluminium geanodiseerd F2 | V = Veiligheidsuitvoering |

VEILIGHEIDSBESLAG

Voorbeeld	Artikelnummer	Type	Blister-formaat in mm	Product(en) per blister	Groot-verpakking	Info-pagina
	6665-10-11/BL55	Curve Kruk Veiligheidsbeslag PC55 anti-kerntrek	340 x 187 x 30	1	4	211
	6665-10-11/BL72	Curve Kruk Veiligheidsbeslag PC72 anti-kerntrek	340 x 187 x 30	1	4	211
	6665-10-29/BL72	Curve Kruk Veiligheidsbeslag PC72 anti-kerntrek	340 x 187 x 30	1	4	205
	6665-10-11/BL92	Curve Kruk Veiligheidsbeslag PC92 anti-kerntrek	340 x 187 x 30	1	4	211

Voorbeeld	Artikelnummer	Type	Blister-formaat in mm	Product(en) per blister	Groot-verpakking	Info-pagina
	6765-10-11/BL55	Curve Smal Kruk Veiligheidsbeslag PC55 anti-kerntrek	340 x 187 x 30	1	4	209
	6765-10-11/BL72	Curve Smal Kruk Veiligheidsbeslag PC72 anti-kerntrek	340 x 187 x 30	1	4	209

Voorbeeld	Artikelnummer	Type	Blister-formaat in mm	Product(en) per blister	Groot-verpakking	Info-pagina
	6660-10-11/BL55	Curve Kruk Veiligheidsbeslag PC55	340 x 187 x 30	1	4	222
	6660-10-11/BL72	Curve Kruk Veiligheidsbeslag PC72	340 x 187 x 30	1	4	222

- 08 = Messing vernikkeld
- 11 = Aluminium geslepen F1
- 22 = Staal galvanisch verzinkt
- 23 = Topcoat gegalvaniseerd staal

- 29 = Aluminium geslepen Inox
- 32 = Aluminium Satin Inox
- 37 = Staal vernikkeld
- 44 = Staal bruin

- 49 = Staal grijs
- 54 = Staal wit
- 62 = Messing mat vernikkeld
- 64 = Zamac galvanisch verzinkt

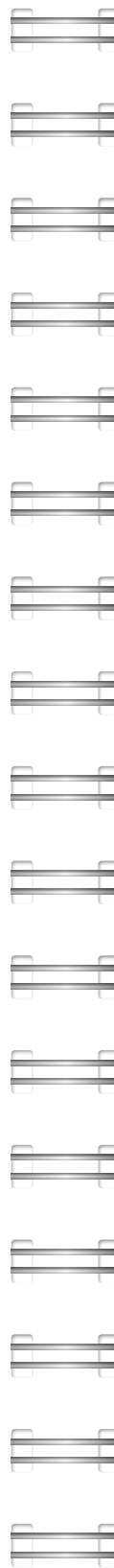

VEILIGHEIDSBESLAG

Voorbeeld	Artikelnummer	Type	Blister-formaat in mm	Product(en) per blister	Groot-verpakking	Info-pagina
	6675-10-11/BL55	Curve Kruk Veiligheidsbeslag PC55 anti-kerntrek	340 x 187 x 30	1	4	211
	6675-10-29/BL55	Curve Kruk Veiligheidsbeslag PC55 anti-kerntrek	340 x 187 x 30	1	4	207
	6675-10-11/BL72	Curve Kruk Veiligheidsbeslag PC72 anti-kerntrek	340 x 187 x 30	1	4	212
	6675-10-29/BL72	Curve Kruk Veiligheidsbeslag PC72 anti-kerntrek	340 x 187 x 30	1	4	207

Voorbeeld	Artikelnummer	Type	Blister-formaat in mm	Product(en) per blister	Groot-verpakking	Info-pagina
	6670-10-11/BL55	Curve Kruk Veiligheidsbeslag PC55	340 x 187 x 30	1	4	232
	6670-10-11/BL72	Curve Kruk Veiligheidsbeslag PC72	340 x 187 x 30	1	4	232

Voorbeeld	Artikelnummer	Type	Blister-formaat in mm	Product(en) per blister	Groot-verpakking	Info-pagina
	6665-00-11/BL55	Curve Veiligheidsschilden PC55 anti-kerntrek	340 x 95 x 35	1	6	211
	6665-00-11/BL72	Curve Veiligheidsschilden PC72 anti-kerntrek	340 x 95 x 35	1	6	211
	6660-00-11/BL55	Curve Veiligheidsschilden PC55	340 x 95 x 35	1	6	221
	6660-00-11/BL72	Curve Veiligheidsschilden PC72	340 x 95 x 35	1	6	221

- 68 = Zamac wit
- 74 = Roestvaststaal wit
- 75 = Roestvaststaal grijs
- 81 = Roestvaststaal

- 88 = Aluminium wit
- 90 = Kunststof grijs
- 91 = Aluminium geanodiseerd F1
- 92 = Aluminium geanodiseerd F2

- 97 = Kunststof antraciet
- 98 = Kunststof wit
- 99 = Kunststof aluminium
- V = Veiligheidsuitvoering

VEILIGHEIDSBESLAG - BINNENDEURSLOTEN

Voorbeeld	Artikelnummer	Type	Bliester-formaat in mm	Product(en) per blister	Groot-verpakking	Info-pagina
	6670-00-11/BL55	Curve Veiligheidsschilden PC55	340 x 95 x 35	1	6	231
	6670-00-11/BL72	Curve Veiligheidsschilden PC72	340 x 95 x 35	1	6	231

Voorbeeld	Artikelnummer	Type	Bliester-formaat in mm	Product(en) per blister	Groot-verpakking	Info-pagina
	6685-00-11/BL	Curve Veiligheidsrozetten recht anti-kerntrek	215 x 95 x 36	1	8	214
	6685-10-11/BL	Curve Veiligheidsrozetten rond anti-kerntrek	215 x 95 x 32	1	8	215
	6685-10-32/BL	Curve Veiligheidsrozetten rond anti-kerntrek	215 x 95 x 32	1	8	215
	6685-20-32/BL	Curve Veiligheidsrozetten ovaal anti-kerntrek	215 x 95 x 36	1	8	N.v.t.
	6680-00-11/BL	Curve Veiligheidsrozetten recht	215 x 95 x 36	1	8	233
	6680-10-11/BL	Curve Veiligheidsrozetten rond	215 x 95 x 32	1	8	234

Voorbeeld	Artikelnummer	Type	Bliester-formaat in mm	Product(en) per blister	Groot-verpakking	Info-pagina
	7115-50-54/55BL	Kastslot SL	275 x 134 x 30	1	5	274
	7115-50-81/55BL	Kastslot SL	275 x 134 x 30	1	5	274
	7135-00-54/55BL	Set dag-nachtslot+schilden SL55	340 x 187 x 48	1	3	274 257
	7135-50-54/55BL	Dag-nachtslot SL55	275 x 134 x 30	1	5	276
	7135-50-81/55BL	Dag-nachtslot SL55	275 x 134 x 30	1	5	276
	7145-00-54/55BL	Set dag-nachtslot+schilden PC55	340 x 187 x 48	1	3	275 256
	7145-50-54/55BL	Dag-nachtslot PC55	275 x 134 x 30	1	5	277
	7145-50-54/81BL	Dag-nachtslot PC55	275 x 134 x 30	1	5	277

- | | | |
|---------------------------|--------------------------------|---------------------------|
| 68 = Zamac wit | 88 = Aluminium wit | 97 = Kunststof antraciet |
| 74 = Roestvaststaal wit | 90 = Kunststof grijs | 98 = Kunststof wit |
| 75 = Roestvaststaal grijs | 91 = Aluminium geanodiseerd F1 | 99 = Kunststof aluminium |
| 81 = Roestvaststaal | 92 = Aluminium geanodiseerd F2 | V = Veiligheidsuitvoering |

BINNENDEURSLOTEN - CILINDERS

Voorbeeld	Artikelnummer	Type	Bliester-formaat in mm	Product(en) per blister	Groot-verpakking	Info-pagina
	7155-00-54/BL	Set loopslot+schilden	340 x 187 x 48	1	3	276 259
	7155-50-54/BL	Loopslot	275 x 134 x 30	1	5	278
	7155-50-81/BL	Loopslot	275 x 134 x 30	1	5	278
	7165-00-54/63BL	Set toilet-backkamerslot+schilden TL63/8	340 x 187 x 48	1	3	279
	7165-50-54/63BL	Toilet-backkamerslot 63/8	275 x 134 x 30	1	5	278
	7165-50-81/63BL	Toilet-backkamerslot 63/8	275 x 134 x 30	1	5	279

Voorbeeld	Artikelnummer	Type	Bliester-formaat in mm	Product(en) per blister	Groot-verpakking	Info-pagina
	7115-40-81/B	Kastdeurslot SL	215 x 95 x 30	1	8	274
	7135-50-22/72BL	Dag-nachtslot SL72	275 x 166 x 30	1	4	276
	7145-50-22/72BL	Dag-nachtslot PC72	275 x 166 x 30	1	4	277
	7155-50-22/BL	Loopslot	215 x 95 x 30	1	8	278

Voorbeeld	Artikelnummer	Type	Bliester-formaat in mm	Product(en) per blister	Groot-verpakking	Info-pagina
	7200-00-08/BL	Dubbele profielcilinder	215 x 95 x 42	1	8	300
	7200-00-08/BL2	Dubbele profielcilinder	215 x 95 x 23	2	8	300
	7200-00-08/BL3	Dubbele profielcilinder	275 x 95 x 33	3	8	300
	7203-00-08/BL	Enkele profielcilinder	215 x 95 x 42	1	8	301
	7205-00-08/BL	Knop profielcilinder	215 x 95 x 42	1	8	302

- | | | |
|-----------------------------------|------------------------------|--------------------------------|
| 08 = Messing vernikkeld | 29 = Aluminium geslepen Inox | 49 = Staal grijs |
| 11 = Aluminium geslepen F1 | 32 = Aluminium Satin Inox | 54 = Staal wit |
| 22 = Staal galvanisch verzinkt | 37 = Staal vernikkeld | 62 = Messing mat vernikkeld |
| 23 = Topcoat gegalvaniseerd staal | 44 = Staal bruin | 64 = Zamac galvanisch verzinkt |

VEILIGHEIDS CILINDERS

Voorbeeld	Artikelnummer	Type	Bliester-formaat in mm	Product(en) per blister	Groot-verpakking	Info-pagina
	7211-00-00/BL	Dubbele veiligheids profielcilinder Security	215 x 95 x 42	1	8	303
	7211-00-08/BL	Dubbele veiligheids profielcilinder Security	215 x 95 x 42	1	8	303
	7211-00-08/BL2	Dubbele veiligheids profielcilinder Security	215 x 95 x 23	2	8	303
	7211-00-08/BL3	Dubbele veiligheids profielcilinder Security	275 x 95 x 33	3	8	303
	7211-00-08/BL4	Dubbele veiligheids profielcilinder Security	275 x 95 x 33	4	8	303
	7211-01-08/BL	Dubbele veiligheids profielcilinder verlengd Security	215 x 95 x 42	1	8	304
	7211-03-08/BL	Dubbele veiligheids profielcilinder verlengd Security	215 x 95 x 42	1	8	304
	7213-00-08/BL	Enkele veiligheids profielcilinder verlengd Security	215 x 95 x 42	1	8	305
	7215-00-08/BL	Knop veiligheids profielcilinder verlengd Security	215 x 95 x 42	1	8	306

Voorbeeld	Artikelnummer	Type	Bliester-formaat in mm	Product(en) per blister	Groot-verpakking	Info-pagina
	7231-00-08/BL	Dubbele veiligheids profielcilinder Comfort&Security	215 x 95 x 42	1	8	307
	7231-00-08/BL2	Dubbele veiligheids profielcilinder Comfort&Security	215 x 95 x 23	2	8	307
	7231-00-08/BL3	Dubbele veiligheids profielcilinder Comfort&Security	275 x 95 x 33	3	8	307
	7231-01-08/BL	Dubbele veiligheids profielcilinder verlengd Comfort&Security	215 x 95 x 42	1	8	308
	7231-03-08/BL	Dubbele veiligheids profielcilinder verlengd Comfort&Security	215 x 95 x 42	1	8	308
	7233-00-08/BL	Enkele veiligheids profielcilinder Comfort&Security	215 x 95 x 42	1	8	309
	7235-00-08/BL	Knop veiligheids profielcilinder Comfort&Security	215 x 95 x 42	1	8	310
	7251-00-08/BL	Dubbele veiligheids profielcilinder Ultimate Security	215 x 95 x 42	1	8	311
	7251-00-08/BL2	Dubbele veiligheids profielcilinder Ultimate Security	215 x 95 x 23	2	8	311
	7261-00-08/BL	Dubbele veiligheids profielcilinder Xtreme Security	215 x 95 x 42	1	8	312
7261-00-08/BL2	Dubbele veiligheids profielcilinder Xtreme Security	215 x 95 x 23	2	8	312	

- 68 = Zamac wit
- 74 = Roestvaststaal wit
- 75 = Roestvaststaal grijs
- 81 = Roestvaststaal

- 88 = Aluminium wit
- 90 = Kunststof grijs
- 91 = Aluminium geanodiseerd F1
- 92 = Aluminium geanodiseerd F2

- 97 = Kunststof antraciet
- 98 = Kunststof wit
- 99 = Kunststof aluminium
- V = Veiligheidsuitvoering



VEILIGHEIDS DEURSLOTEN - KIERSTANDHOUDERS

Voorbeeld	Artikelnummer	Type	Bliester-formaat in mm	Product(en) per blister	Groot-verpakking	Info-pagina
	7318-00-91/BL	Greep inboorgrendel	155 x 95 x 32	1	8	319
	7320-25-91/BL	Inboorgrendel+sluitplaat DM25	155 x 95 x 32	1	8	323
	7320-35-91/BL	Inboorgrendel+sluitplaat DM35	155 x 95 x 32	1	8	323
	7320-50-91/BL	Inboorgrendel+sluitplaat DM50	155 x 95 x 32	1	8	323
	7321-50-91/BL	Inboorgrendel+sluitkom DM50	155 x 95 x 32	1	8	324
	7322-25-81/BL	Inboorgrendel afsluitbaar+sluitkom DM25	155 x 95 x 32	1	8	N.v.t.
	7324-50-91/BL	Inboorgrendel toilet DM50	215 x 95 x 48	1	8	N.v.t.
	7325-50-91/BL	Inboorgrendel afsluitbaar+sluitplaat DM50	215 x 95 x 48	1	8	325

Voorbeeld	Artikelnummer	Type	Bliester-formaat in mm	Product(en) per blister	Groot-verpakking	Info-pagina
	7350-00-62/BL	Kierstandhouder IN	215 x 95 x 47	1	8	N.v.t.
	7351-20-81/BL	Kierstandhouder IN	215 x 95 x 47	1	8	320

Voorbeeld	Artikelnummer	Type	Bliester-formaat in mm	Product(en) per blister	Groot-verpakking	Info-pagina
	7415-50-81/55BL	Veiligheidsinsteek dag-nachtslot PC55+kom	275 x 166 x 30	1	4	279
	7420-50-81/55BL	Veiligheidsinsteek dag-nachtslot PC55+kom	275 x 166 x 30	1	4	280
	7420-50-81/72BL	Veiligheidsinsteek dag-nachtslot PC72+kom	275 x 166 x 30	1	4	283
	7421-50-81/55BL	Veiligheidsinsteek dag-nachtslot PC55+kom	275 x 166 x 30	1	4	290
	7425-50-81/72BL	Veiligheidsinsteek dag-nachtslot PC72+kom	275 x 166 x 30	1	4	286
	7480-50-81/BL	Veilig. insteekbijzetslot DM50	275 x 166 x 30	1	4	288
	7480-60-81/BL	Veilig. insteekbijzetslot DM60	275 x 166 x 30	1	4	288
	7488-47-37/BL	Veilig. penbijzetslot DM47	190 x 130 x 30	1	6	298
	7488-47-37/BL2	Veilig. penbijzetslot DM47	215 x 166 x 30	2	6	298
	7420-45-64/BL	Veiligheids sluitkom	215 x 95 x 30	1	8	290

- 08 = Messing vernikkeld
- 11 = Aluminium geslepen F1
- 22 = Staal galvanisch verzinkt
- 23 = Topcoat gegalvaniseerd staal

- 29 = Aluminium geslepen Inox
- 32 = Aluminium Satin Inox
- 37 = Staal vernikkeld
- 44 = Staal bruin

- 49 = Staal grijs
- 54 = Staal wit
- 62 = Messing mat vernikkeld
- 64 = Zamac galvanisch verzinkt

BARRIËRESTANGEN - DEURBEVEILIGINGSSTRIPS

Voorbeeld	Artikelnummer	Type	Blister-formaat in mm	Product(en) per blister	Groot-verpakking	Info-pagina
	3900-40-54/BL	Deursluiser 3900	480 x 95 x 26	1	25	N.v.t.
	7501-00-49/BL	Deursluiser 7501	215 x 95 x 40	1	8	N.v.t.
	7501-00-54/BL	Deursluiser 7501	215 x 95 x 40	1	8	N.v.t.
	7504-00-49/BL	Deurdranger 7504	215 x 295 x 75	1	6	N.v.t.

Voorbeeld	Artikelnummer	Type	Blister-formaat in mm	Product(en) per blister	Groot-verpakking	Info-pagina
	7610-60-54/BL	Barriërestang V3-Uni	640 x 100 x 50	1	6	332
	7611-68-54/BL	Barriërestang V3-Curve	730 x 100 x 50	1	6	333
	7612-10-54/BL	Barriërestang V1	1130 x 34 x 34	1	6	334
	7612-10-81/BL	Barriërestang V1	1130 x 34 x 34	1	6	334
	7614-95-54/BL	Barriërestang V2	1060 x 50 x 50	1	6	335
	7614-95-81/BL	Barriërestang V2	1060 x 50 x 50	1	6	335

Voorbeeld	Artikelnummer	Type	Blister-formaat in mm	Product(en) per blister	Groot-verpakking	Info-pagina	
	7602-00-88/BL	Deurbeveiligingsstrip M2-IN	2175 x 28 x 28	1	6	314	
	7602-00-91/BL	Deurbeveiligingsstrip M2-IN	2175 x 28 x 28	1	6	314	
	7603-00-88/BL	Deurbeveiligingsstrip M3-EX	2175 x 40 x 40	1	6	315	
	7603-00-91/BL	Deurbeveiligingsstrip M3-EX	2175 x 40 x 40	1	6	315	
	7603-05-88/BL	Deurbeveiligingsstrip M3-EX	2175 x 40 x 40	1	6	316	
	7603-05-91/BL	Deurbeveiligingsstrip M3-EX	2175 x 40 x 40	1	6	316	
	7603-10-88/BL	Deurbeveiligingsstrip M3-EX	2175 x 45 x 45	1	6	317	
	7603-10-91/BL	Deurbeveiligingsstrip M3-EX	2175 x 45 x 45	1	6	317	
	7603-15-88/BL	Deurbeveiligingsstrip M3-EX	2175 x 45 x 45	1	6	318	
	7603-15-91/BL	Deurbeveiligingsstrip M3-EX	2175 x 45 x 45	1	6	318	
	7603-20-88/BL	Deurbeveiligingsstrip M3-EX	2175 x 45 x 45	1	6	319	
	7603-20-91/BL	Deurbeveiligingsstrip M3-EX	2175 x 45 x 45	1	6	319	

- | | | |
|---------------------------|--------------------------------|---------------------------|
| 68 = Zamac wit | 88 = Aluminium wit | 97 = Kunststof antraciet |
| 74 = Roestvaststaal wit | 90 = Kunststof grijs | 98 = Kunststof wit |
| 75 = Roestvaststaal grijs | 91 = Aluminium geanodiseerd F1 | 99 = Kunststof aluminium |
| 81 = Roestvaststaal | 92 = Aluminium geanodiseerd F2 | V = Veiligheidsuitvoering |



DEURBEVEILIGINGSSTRIPS - DEURSPIONNEN

Voorbeeld	Artikelnummer	Type	Blister-formaat in mm	Product(en) per blister	Groot-verpakking	Info-pagina	
	7606-00-88/BL	Deurbeveiligingsstrip M2-IN	2375 x 28 x 28	1	6	314	
	7606-00-91/BL	Deurbeveiligingsstrip M2-IN	2375 x 28 x 28	1	6	314	
	7607-00-88/BL	Deurbeveiligingsstrip M3-EX	2375 x 40 x 40	1	6	315	
	7607-00-91/BL	Deurbeveiligingsstrip M3-EX	2375 x 40 x 40	1	6	315	
	7607-05-88/BL	Deurbeveiligingsstrip M3-EX	2375 x 40 x 40	1	6	316	
	7607-05-91/BL	Deurbeveiligingsstrip M3-EX	2375 x 40 x 40	1	6	316	
	7607-10-88/BL	Deurbeveiligingsstrip M3-EX	2375 x 45 x 45	1	6	317	
	7607-10-91/BL	Deurbeveiligingsstrip M3-EX	2375 x 45 x 45	1	6	317	
	7607-15-88/BL	Deurbeveiligingsstrip M3-EX	2375 x 45 x 45	1	6	318	
	7607-15-91/BL	Deurbeveiligingsstrip M3-EX	2375 x 45 x 45	1	6	318	
	7607-20-88/BL	Deurbeveiligingsstrip M3-EX	2375 x 45 x 45	1	6	319	
	7607-20-91/BL	Deurbeveiligingsstrip M3-EX	2375 x 45 x 45	1	6	319	

Voorbeeld	Artikelnummer	Type	Blister-formaat in mm	Product(en) per blister	Groot-verpakking	Info-pagina
	7820-00-90/BL	Digitale deurspion DDS1	245 x 330 x 42	1	20	327
	7831-00-62/BL	Deurspion	155 x 95 x 27	1	8	328

- | |
|--------------------------------|
| 62 = Messing mat vernikkeld |
| 88 = Aluminium wit |
| 90 = Kunststof grijs |
| 91 = Aluminium geanodiseerd F1 |

Index



INDEX | VERPAKKINGEN | ASSA | RAAMPRODUCTEN | DEURPRODUCTEN | DEURCILINDERS | DEURSLOTEN | DEURBESLAG | RAAMSLUITINGEN | UITZETTERS | SCHARNIEREN

A

Accessoires raamopener AXA Remote 2.0	101
ASSA Toegangsmanagement	338, 339

B

Barrièrestang V1	334
Barrièrestang V2	335
Barrièrestang V3 Curve	333
Barrièrestang V3 Uni	332
Briefplaat	267
Briefplaat Curve	267
Briefplaat met naamplaat	268

C

Cilinder	300, 301, 302
Combi-raamuitzetter AXAfIX	115, 116, 117
Combi-raamuitzetter AXAflex	103, 104
Combi-raamuitzetter AXAflex Classic	113, 114
Combi-raamuitzetter AXAflex de Luxe	110, 111, 112
Combi-raamuitzetter AXAflex Security	102
Combi-raamuitzetter AXAflex Speciaal	105, 106, 107, 108, 109
Curve binnendeurozetten	264
Curve binnendeurschilden	257
Curve kastdeurschild	263
Curve kastdeurschilden	262
Curve Klik binnendeurozetten	252, 253
Curve Klik kastdeurschild	251
Curve Klik kastdeurschilden	250
Curve Klik loopdeurschilden	249
Curve Klik PC binnendeurschilden	246
Curve Klik PC binnendeurozetten	255
Curve Klik SL binnendeurozetten	254
Curve Klik SL binnendeurschilden	247
Curve Klik toiletdeurozetten	256
Curve Klik toiletdeurschilden	248
Curve loopdeurschilden	261
Curve PC binnendeurozetten	266
Curve PC binnendeurschilden	258
Curve SL binnendeurozetten	265
Curve SL binnendeurschilden	259
Curve toiletdeurschilden	260
Curve veiligheidsbeslag comfort duwer	220
Curve veiligheidsbeslag comfort S-knop	221
Curve veiligheidsbeslag comfort S-knop anti-kerntrek	210
Curve veiligheidsbeslag D-duwer anti-kerntrek	203
Curve veiligheidsbeslag duwer	217
Curve veiligheidsbeslag kruk	219
Curve veiligheidsbeslag kruk anti-kerntrek	205, 207
Curve veiligheidsbeslag S-knop	218
Curve veiligheidsbeslag S-knop anti-kerntrek	206
Curve veiligheidsbeslag S-knop kort anti-kerntrek	204
Curve veiligheidsbeslag smal D-duwer anti-kerntrek	208
Curve veiligheidsbeslag smal kruk anti-kerntrek	209
Curve veiligheids binnenschild	229, 230, 231
Curve veiligheids buitenschild	225, 226, 227, 228
Curve veiligheidsrozetten	233, 234
Curve veiligheidsrozetten anti-kerntrek	214, 215
Curve veiligheidsrozetten smal anti-kerntrek	216
Curve veiligheidsschilden	222, 223, 232
Curve veiligheidsschilden anti-kerntrek	211, 212
Curve veiligheidsschilden comfort	224
Curve veiligheidsschilden comfort anti-kerntrek	213

D

Dag-nachtslot PC	277
Dag-nachtslot SL	276
Dakraamset raamopener AXA Remote 2.0	100
Deurbeveiligingsstrip M2-IN	314
Deurbeveiligingsstrip M3-EX 0-4	315
Deurbeveiligingsstrip M3-EX 5-9	316
Deurbeveiligingsstrip M3-EX 10-14	317
Deurbeveiligingsstrip M3-EX 15-19	318
Deurbeveiligingsstrip M3-EX 20-25	319
Deurknop Paddestoel	269
Deurknop Schaal	269
Deurkruk Blok	242
Deurkruk Blok zwaar	239
Deurkruk C	237
Deurkruk Curve	238
Deurkruk Duim	244
Deurkruk L	235
Deurkruk Sabel	240
Deurkruk S-knop	241
Deurkruk U	236
Deurkruk Viender	243
Deurspion	328
Deurstoppers	329
Dievenklauw	88
Digitale deurspion	326
Digitale deurspion met deurbel	327

H

Heavy Duty schijfslagerscharnier	84
Heavy Duty veiligheids ongelagerd scharnier	83
Heavy Duty veiligheids schijfslagerscharnier	85, 86, 87

I

Inboorgrendel	323, 324, 325
Inboorpaumelle	37

K

Kastslot PC	275
Kastslot SL	274
Kierstandhouder EX	321, 322
Kierstandhouder IN	320
Kogellagerscharnier	56, 57, 58, 59, 60
Kogelstiftpaumelle	44, 46, 52, 54

L

Loopslot	278
----------	-----

N

Nylonlager veiligheidsscharnier	28
---------------------------------	----

O

Onderdelen en accessoires deurbeslag	270, 271, 272
Onderdelen en accessoires raamsluitingen	179, 180, 181
Onderdelen en accessoires scharnieren	89, 90, 91, 92
Onderdelen en accessoires uitzettters	135
Ongelagerd klepscharnier	23
Ongelagerd scharnier	17, 18, 19, 20, 21, 22
Ongelagerd veiligheids scharnier	24, 26, 27
Ongelagerd veiligheidsscharnier	25
Oplegdeurslot	294, 295, 297
Opleggrendelslot	296
Oplegslot 3011	173

P

Premium veiligheidsbeslag comfort D-duwer Arrow	192
Premium veiligheidsbeslag comfort kruk Flow	194
Premium veiligheidsbeslag comfort kruk Wing Flow	193
Premium veiligheidsbeslag D-duwer Arrow	184
Premium veiligheidsbeslag D-duwer Flow	185
Premium veiligheidsbeslag kruk Arrow	190
Premium veiligheidsbeslag kruk Flow	191
Premium veiligheidsbeslag kruk Wing Arrow	186
Premium veiligheidsbeslag kruk Wing Flow	187
Premium veiligheidsbeslag smal D-duwer Arrow	195
Premium veiligheidsbeslag smal D-duwer Flow	196
Premium veiligheidsbeslag smal kruk Arrow	201
Premium veiligheidsbeslag smal kruk Flow	202
Premium veiligheidsbeslag smal kruk Wing Arrow	197
Premium veiligheidsbeslag smal kruk Wing Flow	198
Premium veiligheidsbeslag smal Wing-knop Arrow	199
Premium veiligheidsbeslag smal Wing-knop Flow	200
Premium veiligheidsbeslag Wing-knop Arrow	188
Premium veiligheidsbeslag Wing-knop Flow	189

R

Raamknip	177
Raamopener AXA Remote 2.0	94, 97, 98, 99
Raamopener AXA Remote 2.0 Solar	95
Raamopener AXA Remote 2.0 Synchroon	96
Raamsluiting	140, 141, 142, 143, 144, 145, 146, 147, 148, 149
Raamsluiting met inbouwsluitkom	150, 151
Raamsluiting met opbouwsluitkom	152, 153
Raamuitzetter Elite	122, 123
Raamuitzetter Habilis	118, 119, 120

S

Sluitplaten veiligheids sloten	291, 292, 293
Sluitplaten voor binnendeursloten	280
Smal scharnier	16
Smart Easyfix® renovatie veiligheidsscharnier	81
Smart Easyfix® scharnier	75
Smart Easyfix® veiligheidsscharnier	76, 77, 78, 79, 80
Smart Easyfix® XDK veiligheidsscharnier	82
Smart kogellagerscharnier	73
Smart ongelagerd scharnier	66, 67
Smart ongelagerd veiligheidsscharnier	68, 69
Smart schijfslagerscharnier	70
Smart veiligheids kogellagerscharnier	74
Smart veiligheids schijfslagerscharnier	71, 72

T

Telescopische uitzetter 20EX	125
Telescopische uitzetter 20IN	131
Telescopische uitzetter 30EX	126, 127
Telescopische uitzetter 30IN	132
Telescopische uitzetter 35EX	128
Telescopische uitzetter 35IN	133
Telescopische uitzetter 50EX	129
Telescopische uitzetter 50IN	134
Telescopische uitzetter 55EX	130
Toiletslot	279

U

Uitzetterpen raamuitzetter Elite	124
Uitzetterpen raamuitzetter Habilis	121

V

Valijzer	177
Veiligheids bijzetslot	288, 289
Veiligheids cilinder Comfort & Security	307
Veiligheids cilinder Comfort & Security enkel	309
Veiligheids cilinder Comfort & Security knop	310
Veiligheids cilinder Comfort & Security verlengd	308
Veiligheids cilinder Security	303
Veiligheids cilinder Security enkel	305
Veiligheids cilinder Security knop	306
Veiligheids cilinder Security verlengd	304
Veiligheids cilinder Ultimate Security	311
Veiligheids cilinder Xtreme Security	312
Veiligheids combi-raamsluiting Oyster	138, 139
Veiligheids draai-kiem raamkruk	172
Veiligheids insteek dag-nachtslot	281, 282, 283, 284, 285, 286, 287
Veiligheids kogellagerscharnier	61, 62, 63, 64, 65
Veiligheids kogelstiftpaumelle	38, 39, 40, 41, 42, 43, 45, 47, 48, 49, 50, 51, 53, 55
Veiligheids oplegslot 3012	174
Veiligheids oplegslot 3015	175
Veiligheids oplegslot 3016	176
Veiligheids penbijzetslot	298
Veiligheids raamsluiting met inbouwsluitkom	154, 155, 162, 163
Veiligheids raamsluiting met opbouwsluitkom	156, 157, 164, 165, 170, 171
Veiligheids raamsluiting met sluithaak	160, 161
Veiligheids raamsluiting met sluitplaat	168, 169
Veiligheids raamsluiting met smalle opbouwsluitkom	158, 159, 166, 167
Veiligheids sluitkommen	290
Venelite scharnier	29, 32, 33, 34
Venelite veiligheids scharnier	30, 31, 35, 36
Ventilatierozet	178

7261-00-08/BL2*	312	7603-20-91/BL*	319
7312-00-22/E	296	7606-00-88/BL*	314
7313-70-22/E	297	7606-00-91/BL*	314
7320-25-91/E	323	7607-00-88/BL*	315
7320-35-91/E	323	7607-00-91/BL*	315
7320-50-91/E	323	7607-05-88/BL*	316
7321-50-91/E	324	7607-05-91/BL*	316
7325-50-91/E	325	7607-10-88/BL*	317
7351-20-81*	320	7607-10-91/BL*	317
7351-21-81**	320	7607-15-88/BL*	318
7355-15-81/L*	321	7607-15-91/BL*	318
7355-15-81/R*	322	7607-20-88/BL*	319
7410-15-81/55EL	291	7607-20-91/BL*	319
7410-15-81/55ER	291	7610-60-54/BL*	332
7415-15-81/55EL	291	7611-68-54/BL*	333
7415-15-81/55ER	291	7612-10-54/BL*	334
7415-35-66/55E	290	7612-10-81/BL*	334
7415-50-81/55E	281	7614-95-54/BL*	335
7420-10-81/55EL	291	7614-95-81/BL*	335
7420-10-81/55ER	291	7800-00-90	326
7420-10-81/72EL	291	7820-00-90	327
7420-10-81/72ER	291	7831-00-62/E	328
7420-45-64/E	290		
7420-50-81/55E	282		
7420-50-81/72E	283		
7421-10-81/55EL	293		
7421-10-81/55ER	293		
7421-45-64/E	290		
7421-50-81/55E	284		
7425-15-81/55EL	292		
7425-15-81/55ER	292		
7425-15-81/72EL	292		
7425-15-81/72ER	292		
7425-25-81/55EL	292		
7425-25-81/55ER	292		
7425-25-81/72EL	292		
7425-25-81/72ER	292		
7425-50-81/55E	285		
7425-50-81/72E	286		
7426-15-81/55EL	293		
7426-15-81/55ER	293		
7426-25-81/55EL	293		
7426-25-81/55ER	293		
7426-50-81/55E	287		
7480-35-66/E	290		
7480-50-81/E	288		
7480-60-81/E	288		
7485-50-81/E	289		
7485-60-81/E	289		
7488-47-37/E	298		
7488-47-37/E2	298		
7490-51-49	294		
7490-52-49	295		
7602-00-88/BL*	314		
7602-00-91/BL*	314		
7603-00-88/BL*	315		
7603-00-91/BL*	315		
7603-05-88/BL*	316		
7603-05-91/BL*	316		
7603-10-88/BL*	317		
7603-10-91/BL*	317		
7603-15-88/BL*	318		
7603-15-91/BL*	318		
7603-20-88/BL*	319		

AXA'S KLAVERTJE VIER STAAT VOOR AXA'S VIER ZEKERHEDEN DIE U BIJ IEDER AXA PRODUCT MAG VERWACHTEN

☘ 10 jaar
garantie

☘ uitgebreid
getest

☘ Nederlands
product

☘ niet goed,
geld terug

AXA Stenman Nederland BV hanteert een garantie van tien jaar voor de eindgebruiker. De garantie geldt alleen voor producten die onder de merknaam AXA zijn verkocht. Garantie geldt uitsluitend op fabricagefouten die vallen onder de verantwoordelijkheid van AXA.

Ga naar axahomesecurity.com voor de volledige voorwaarden.



 gelukkig is er AXA



 gelukkig is er AXA

U bent van harte welkom!

Wilt u graag een afspraak inplannen met een van onze adviseurs, belt u dan: **0318 536 111**

AXA is onderdeel van de Allegion groep

AXA HOME SECURITY

www.axahomesecurity.com



ALLEGION™

www.allegion.com

AXA Stenman Nederland B.V.
Energiestraat 2, 3903 AV Veenendaal